

Page 01–33

- NeuroSurgery
- Laminectomy

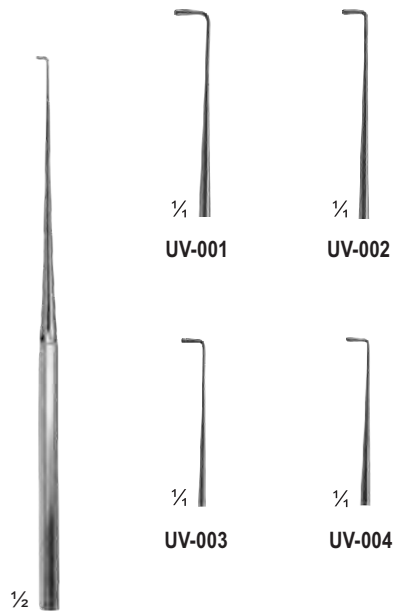

WAGENER
UV-001 - 004
150 mm

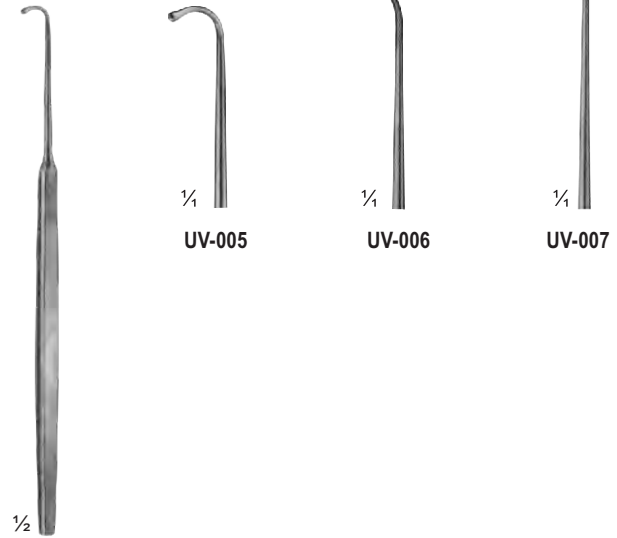

GRAEFE
UV-005 - 007
140 mm



BROM
UV-008
Vein hook
170 mm

CRILE
UV-009
200 mm

CUSHING
UV-010- 011
190 mm



NERVE HOOKS



GRONINGEN
UV-012
265 mm



GRONINGEN
UV-013
265 mm



CUSHING
UV-013 - 014

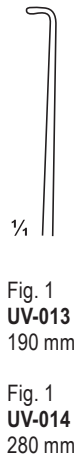

Fig. 1
UV-013
190 mm
Fig. 1
UV-014
280 mm



CUSHING
UV-015 - UV-016

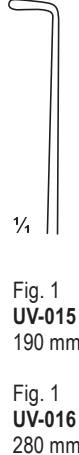

Fig. 1
UV-015
190 mm
Fig. 1
UV-016
280 mm



SMITHWICK
UV-017 - UV-018



UV-017
165 mm

UV-018
210 mm

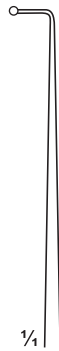

Fig.1
UV-019



Fig.2
UV-020



Fig.1
UV-021



Fig.2
UV-022



CASPER
UV-023 - 026
245 mm





DURA HOOKS

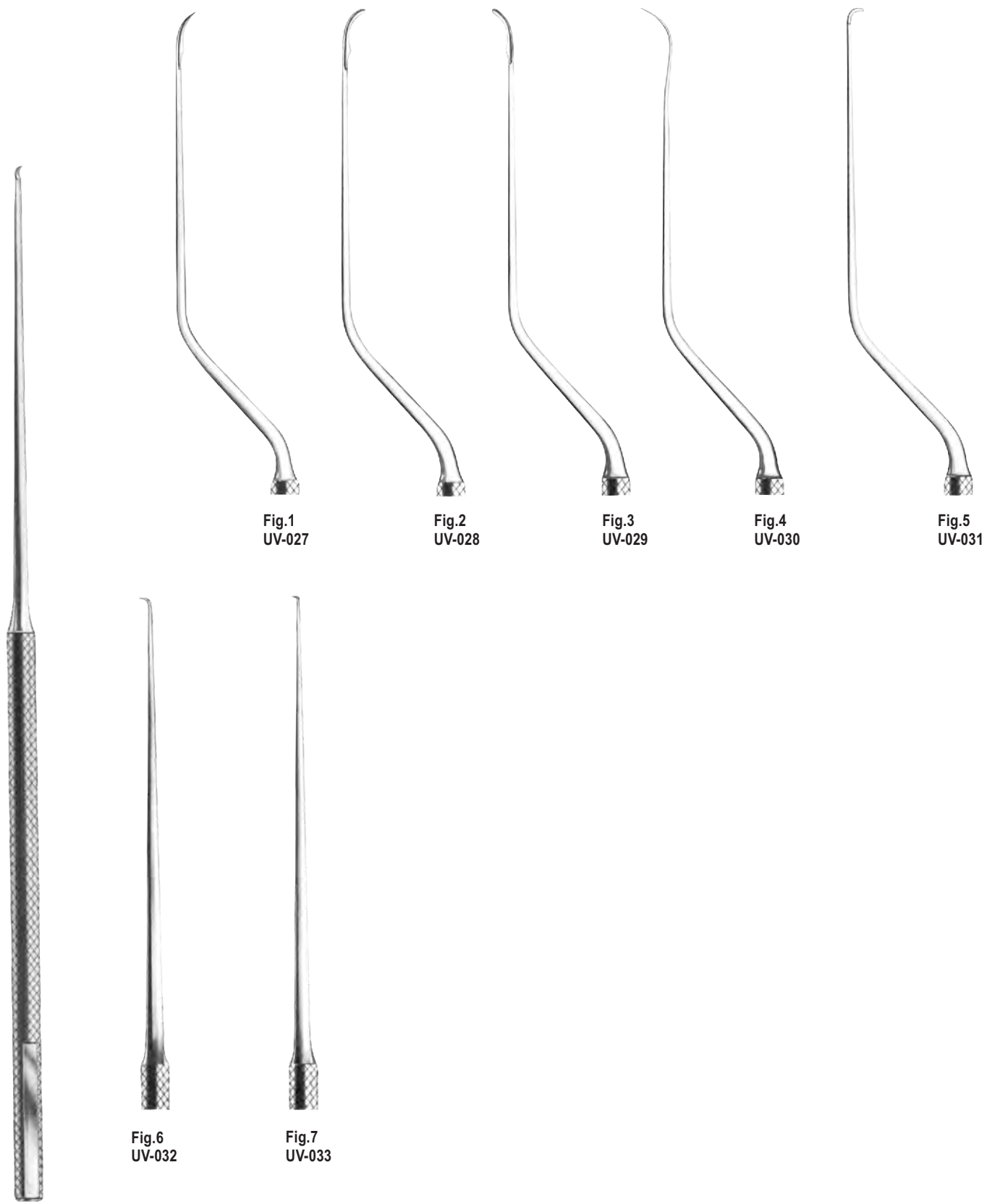

Fig.1
UV-027

Fig.2
UV-028

Fig.3
UV-029

Fig.4
UV-030

Fig.5
UV-031

Fig.6
UV-032

Fig.7
UV-033

UV-027 - 033



YASARGIL
UV-034
190 mm

YASARGIL
UV-035
190 mm

YASARGIL
UV-036
190 mm

YASARGIL
UV-037
190 mm

YASARGIL
UV-038
190 mm

YASARGIL
UV-039
190 mm

JACOBSON
UV-040
190 mm



JACOBSON
UV-041
190 mm

YASARGIL
UV-042
190 mm

UV-043
190 mm

UV-044
190 mm

YASARGIL

UV-045
190 mm

UV-046
190 mm

YASARGIL
UV-047
190 mm



DURA DISSECTORS

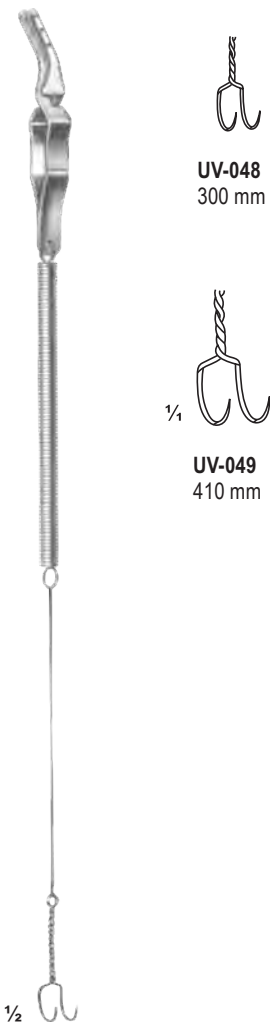

YASARGIL
UV-048 - 049
Galea Hook

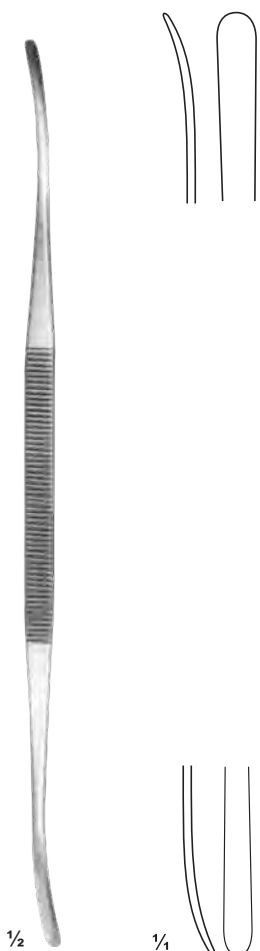

TOENNIS
UV-050
240 mm

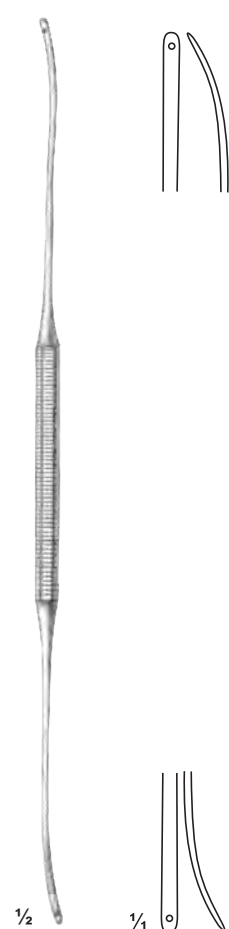

OLIVECRONA
UV-051
240 mm



HESS
Nerve Root Retractor
UV-052 - 054
UV-052 175 mm 3 mm
UV-053 175 mm 5 mm
UV-054 175 mm 7 mm



LOVE
Nerve Root Retractor
UV-055 - 057
UV-055 190 mm 30°
UV-056 190 mm 45°
UV-057 190 mm 90°



CASPAR
Nerve Root Retractor
UV-058 - 060
UV-058 245 mm 6 mm
UV-059 245 mm 8 mm
UV-060 245 mm 10 mm



LOVE
UV-061
210 mm



NERVE ROOT RETRACTORS



SCOVILLE
UV-062
235 mm

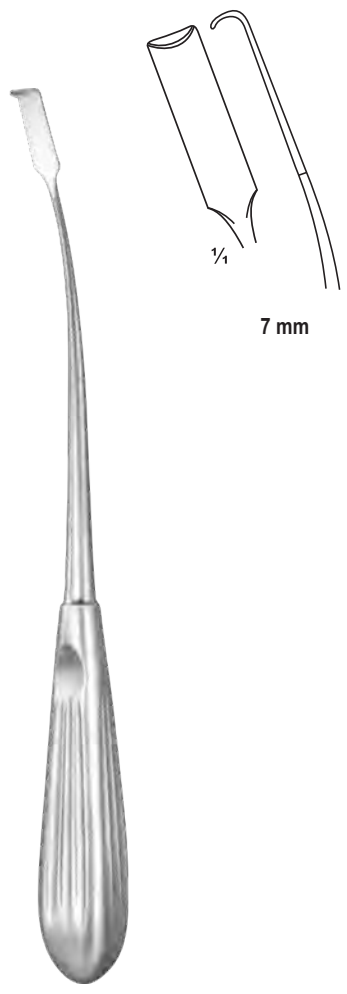

HOLSHER
UV-063
240 mm

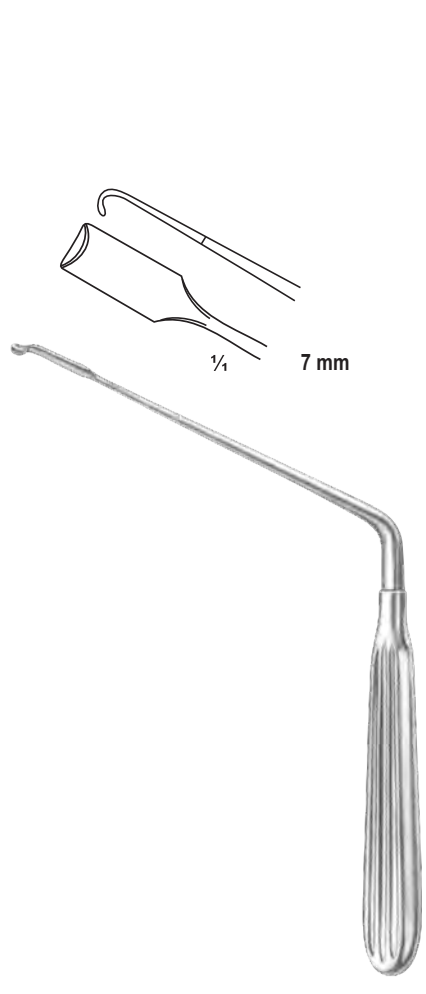

SCOVILLE
UV-064
165 mm

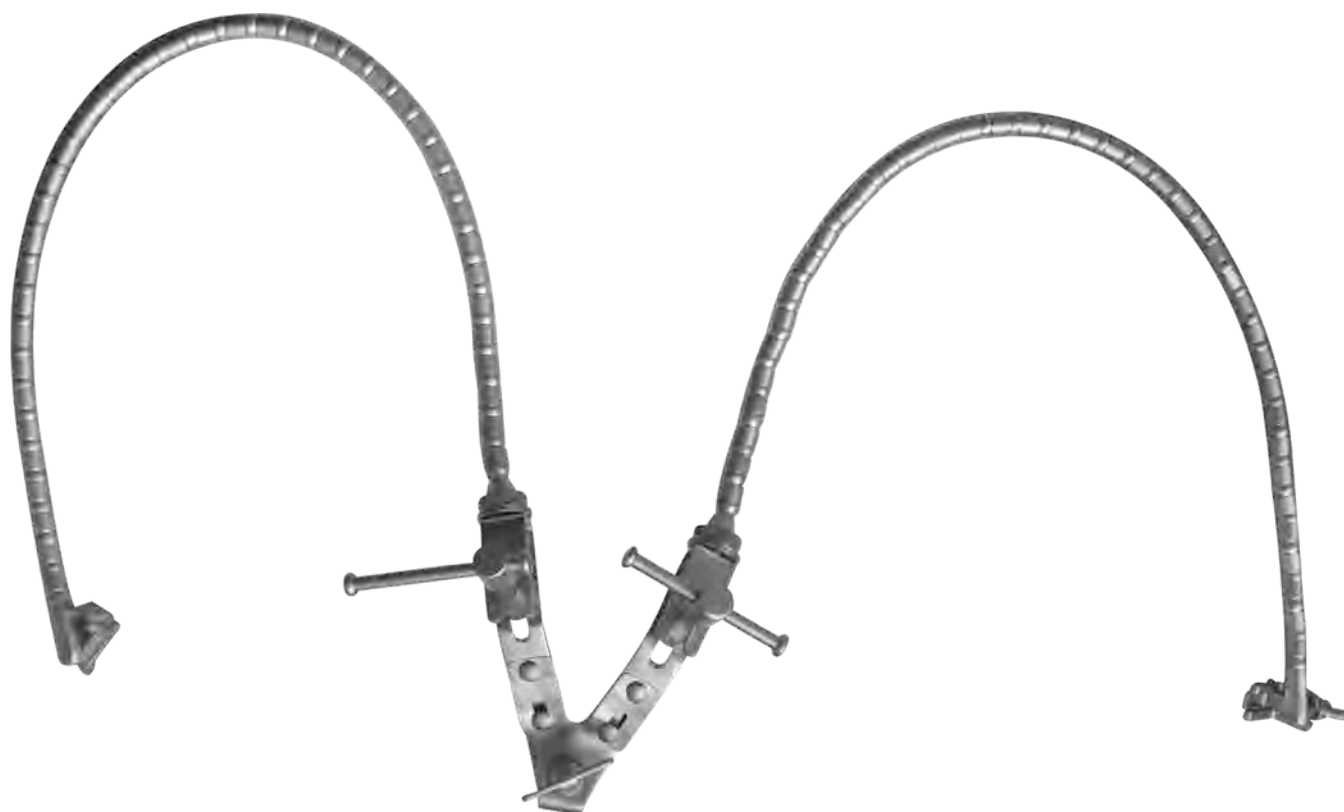

LEYLA
UV-065
Self-Retaining brain retractor
with 2 arms complete

LEYLA BED RETRACTOR
UV-066
Self-Retaining brain retractor
bed retractor not illustrated



BRAIN SPATULAS



OLIVECRONA
UV-067 - 070
180 mm
Concave

UV-067 7 + 9 mm
UV-068 11 + 13 mm
UV-069 15 + 18 mm
UV-070 18 + 22 mm



UV-071
15.5 cm
11 mm

UV-072
20 cm
14 mm

UV-073
20 cm
17 mm

UV-074
20 cm
20 mm

HEIFETZ
UV-071 - 074

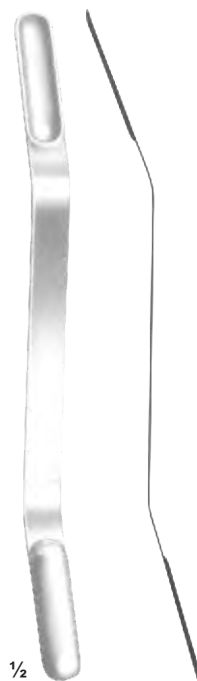

OLIVECRONA
UV-075 - 078
180 mm
Convex

UV-075 7 + 9 mm
UV-076 11 + 13 mm
UV-077 15 + 18 mm
UV-078 18 + 22 mm



UV-079
8 mm

UV-080
14 mm

UV-081
17 mm

HEIFETZ
UV-079 - 081
155 mm



**CASPAR
UV-082**
Transverse Retractor hinged
65 mm regular spread
110 mm wide spread



**CASPAR
UV-083**
Transverse Retractor double-hinged
65 mm spread



**CASPAR
UV-084**
Longitudinal Retractor
double-hinged, ring handle
205 mm
85 mm spread

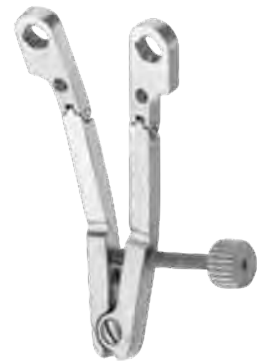

**CASPAR
UV-085**
Specula Retractor single-hinged,
115 mm
70mm regular spread



UV-086 - 094
UV-087 23 x 35 mm
UV-088 23 x 40 mm
UV-089 23 x 45 mm
UV-090 23 x 50 mm
UV-091 23 x 55 mm
UV-092 23 x 60 mm
UV-093 23 x 65 mm
UV-094 23 x 70 mm
Medial Toothed Blades
Stainless Steel



UV-095 - 099
UV-095 15 x 40 mm
UV-096 15 x 45 mm
UV-097 15 x 50 mm
UV-098 15 x 55 mm
UV-099 15 x 60 mm
Small Lateral Blades
Stainless Steel



UV-100 - 106
UV-100 23 x 40 mm
UV-101 23 x 45 mm
UV-102 23 x 50 mm
UV-103 23 x 55 mm
UV-104 23 x 60 mm
UV-105 23 x 65 mm
UV-106 23 x 70 mm
Lateral Serrated Blades
Stainless Steel



Cervical Blades
Stainless Steel – fenestrated
UV-107 - 108
UV-107 25 x 50 mm
UV-108 25 x 60 mm



UV-109 - 117
UV-109 23 x 35 mm
UV-110 23 x 40 mm
UV-111 23 x 45 mm
UV-112 23 x 50 mm
UV-113 23 x 55 mm
UV-114 23 x 60 mm
UV-115 23 x 65 mm
UV-116 23 x 70 mm
UV-117 23 x 75 mm
Blunt Blades
Stainless Steel



UV-118 - 122
UV-118 23 x 40 mm
UV-119 23 x 45 mm
UV-120 23 x 50 mm
UV-121 23 x 55 mm
UV-122 23 x 60 mm
Medial Toothed Blades
Aluminium – rotatating



UV-123 - 127
UV-123 23 x 40 mm
UV-124 23 x 45 mm
UV-125 23 x 50 mm
UV-126 23 x 55 mm
UV-127 23 x 60 mm
Lateral Serrated Blades
Aluminium – rotatating



UV-128 - 132
UV-128 23 x 45 mm
UV-129 23 x 50 mm
UV-130 3 x 55 mm
UV-131 23 x 60 mm
UV-132 23 x 65 mm
Blunt Blades
Aluminium – rotatating



RETRACTORS FOR CERVICAL VERTEBRAL COLUMN



CASPAR
UV-133
Transverse Retractor hinged
65 mm spread

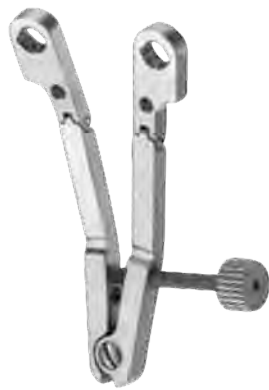

CASPAR
UV-134
Specula Retractor single-hinged
115 mm,
70 mm spread



CASPAR
UV-135
Longitudinal Retractor
single-hinged ring handle
175 mm
70 mm spread



UV-136 - 143
UV-136 20 x 40 mm
UV-137 20 x 45 mm
UV-138 20 x 50 mm
UV-139 20 x 55 mm
UV-140 20 x 60 mm
UV-141 20 x 65 mm
UV-142 20 x 70 mm
UV-143 20 x 75 mm
Medial Toothed Blades



UV-144 - 154
UV-144 20 x 25 mm
UV-145 20 x 30 mm
UV-146 20 x 35 mm
UV-147 20 x 40 mm
UV-148 20 x 45 mm
UV-149 20 x 50 mm
UV-150 20 x 55 mm
UV-151 20 x 60 mm
UV-152 20 x 65 mm
UV-153 20 x 70 mm
UV-154 20 x 75 mm
Lateral Serrated Blades



UV-155 - 164
UV-155 20 x 30 mm
UV-156 20 x 35 mm
UV-157 20 x 40 mm
UV-158 20 x 45 mm
UV-159 20 x 50 mm
UV-160 20 x 55 mm
UV-161 20 x 60 mm
UV-162 20 x 65 mm
UV-163 20 x 70 mm
UV-164 20 x 75 mm
Blunt Blades

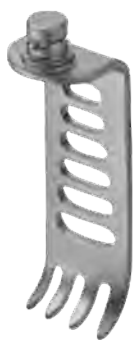

UV-165 - 172
UV-165 20 x 35 mm
UV-166 20 x 40 mm
UV-167 20 x 45 mm
UV-168 20 x 50 mm
UV-169 20 x 55 mm
UV-170 20 x 60 mm
UV-171 20 x 65 mm
UV-172 0 x 70 mm
Medial Toothed Blades
fenestrated



UV-173 - 182
UV-173 20 x 25 mm
UV-174 20 x 30 mm
UV-175 20 x 35 mm
UV-176 20 x 40 mm
UV-177 20 x 45 mm
UV-178 20 x 50 mm
UV-179 20 x 55 mm
UV-180 20 x 60 mm
UV-181 20 x 65 mm
UV-182 20 x 70 mm
Lateral Serrated Blades
Fenestrated



UV-183 - 191
UV-183 20 x 35 mm
UV-184 20 x 40 mm
UV-185 20 x 45 mm
UV-186 20 x 50 mm
UV-187 20 x 55 mm
UV-188 20 x 60 mm
UV-189 20 x 65 mm
UV-190 20 x 70 mm
UV-191 20 x 75 mm
Blunt Blades Fenestrated



CASPAR
UV-192
Transverse Retractor hinged
60 mm spread



CASPAR
UV-193
Transverse Retractor double-hinged
65 mm spread



CASPAR
UV-194
Longitudinal Retractor
single-hinged ring handle
175 mm
70 mm spread



CASPAR
UV-195
Longitudinal Retractor
single-hinged ring handle
175 mm
70 mm spread



RETRACTORS FOR CERVICAL VERTEBRAL COLUMN



UV-196 - 202
UV-196 12 x 40 mm
UV-197 12 x 45 mm
UV-198 12 x 50 mm
UV-199 12 x 55 mm
UV-200 12 x 60 mm
UV-201 12 x 65 mm
UV-202 12 x 75 mm
Small Lateral Serrated
Blades PEEK



UV-203 - 209
UV-203 23 x 40 mm
UV-204 23 x 45 mm
UV-205 23 x 50 mm
UV-206 23 x 55 mm
UV-207 23 x 60 mm
UV-208 23 x 65 mm
UV-209 23 x 75 mm
Lateral Serrated Blades
PEEK



UV-210 - 216
UV-210 23 x 40 mm
UV-211 23 x 45 mm
UV-212 23 x 50 mm
UV-213 23 x 55 mm
UV-214 23 x 60 mm
UV-215 23 x 65 mm
UV-216 23 x 75 mm
Blunt Blades PEEK



UV-217 - 223
UV-217 23 x 40 mm
UV-218 23 x 45 mm
UV-219 23 x 50 mm
UV-220 23 x 55 mm
UV-221 23 x 60 mm
UV-222 23 x 65 mm
UV-223 23 x 75 mm
Medial Toothed Blades
PEEK



UV-224 - 230
UV-224 23 x 40 mm
UV-225 23 x 45 mm
UV-226 23 x 50 mm
UV-227 23 x 55 mm
UV-228 23 x 60 mm
UV-229 23 x 65 mm
UV-230 23 x 75 mm
Lateral Serrated Blades
PEEK – rotatating



UV-231 - 237
UV-231 23 x 40 mm
UV-232 23 x 45 mm
UV-233 23 x 50 mm
UV-234 23 x 55 mm
UV-235 23 x 60 mm
UV-236 23 x 65 mm
UV-237 23 x 75 mm
Blunt Blades
PEEK – rotatating



CASPAR
UV-238
Transverse Retractor double-hinged
quick connect 72 mm spread, side-loading



CASPAR
UV-239
Longitudinal Retractor double-hinged,
ring handle, quick connect
185 mm
75 mm spread, side-loading



CASPAR
UV-240
Specula Retractor single-hinged,
quick connect
115 mm
70 mm spread, side-loading



CASPAR
UV-241
Quick Connect Blade
Positioner Handle
210 mm
for quick connect
blades only



UV-242 - 246
UV-242 23 x 40 mm
UV-243 23 x 45 mm
UV-244 23 x 50 mm
UV-245 23 x 55 mm
UV-246 23 x 60 mm
Medial Toothed Blades
Stainless Steel
quick connect



UV-247 - 251
UV-247 23 x 40 mm
UV-248 23 x 45 mm
UV-249 23 x 50 mm
UV-250 23 x 55 mm
UV-251 23 x 60 mm
Lateral Serrated Blades
Stainless Steel
quick connect



UV-252 - 256
UV-252 23 x 45 mm
UV-253 23 x 50 mm
UV-254 23 x 55 mm
UV-255 23 x 60 mm
UV-256 23 x 65 mm
Blunt Blades
Stainless Steel
quick connect



UV-257 - 261
UV-257 23 x 40 mm
UV-258 23 x 45 mm
UV-259 23 x 50 mm
UV-260 23 x 55 mm
UV-261 23 x 60 mm
Medial Toothed Blades
Titanium
quick connect



UV-262 - 266
UV-262 23 x 40 mm
UV-263 23 x 45 mm
UV-264 23 x 50 mm
UV-265 23 x 55 mm
UV-266 23 x 60 mm
Lateral Serrated Blades
Titanium
quick connect



UV-267 - UV-271
UV-267 23 x 45 mm
UV-268 23 x 50 mm
UV-269 23 x 55 mm
UV-270 23 x 60 mm
UV-271 23 x 65 mm
Blunt Blades
Titanium
quick connect



RETRACTORS FOR CERVICAL VERTEBRAL COLUMN



**CASPAR
UV-272**
Caspar Cervical Spine Retractor
stainless steel, complete set for transverse retraction, 65 mm
spread, adjustable, with 5 medial and 5 lateral stainless steel,
blades 40, 45, 50, 55, 60 mm

UV-273
TI Caspar Cervical Spine Retractor
titanium, complete set for transverse retraction, 65 mm
spread, adjustable, with 5 medial and 5 lateral titanium
blades 40, 45, 50, 55, 60 mm



CASPAR
UV-274
 Caspar Microdiscectomy Retractor
 for microsurgical treatment of
 herniated lumbar discs
 45 mm spread



UV-275 - 283
UV-275 35 mm
UV-276 40 mm
UV-277 45 mm
UV-278 50 mm
UV-279 55 mm
UV-280 60 mm
UV-281 65 mm
UV-282 75 mm
UV-283 85 mm
 Lateral Blades



UV-284 - 290
UV-284 40 mm
UV-285 45 mm
UV-286 50 mm
UV-287 55 mm
UV-288 60 mm
UV-289 65 mm
UV-290 70 mm
 Paraspina Blades



CASPAR
UV-291 - 300
UV-291 40 mm
UV-292 45 mm
UV-293 50 mm
UV-294 55 mm
UV-295 60 mm
UV-296 65 mm
UV-297 70 mm
UV-298 75 mm
UV-299 80 mm
UV-300 85 mm
 Lumbar Speculum
 fenestrated



RETRACTORS FOR CERVICAL VERTEBRAL COLUMN



UV-305 - 310
UV-305 20 x 30 mm
UV-306 20 x 40 mm
UV-307 20 x 50 mm
UV-308 20 x 60 mm
UV-309 20 x 70 mm
UV-310 20 x 80 mm
 McCulloch 4-teeth
 Narrow Muscle Blades



UV-311 - 316
UV-311 20 x 30 mm
UV-312 20 x 40 mm
UV-313 20 x 50 mm
UV-314 20 x 60 mm
UV-315 20 x 70 mm
UV-316 20 x 80 mm
 McCulloch 6-teeth
 Wide Muscle Blades

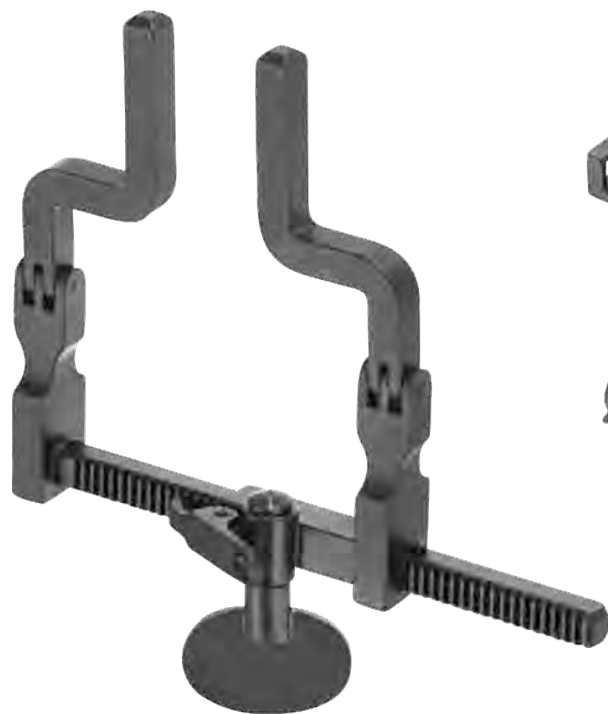

CASPAR
 McCulloch Lumbar Spine Retractor for Microdiscectomy,
 black silicone bead
UV-301 68 mm spread, hinged
UV-302 68 mm spread, rigid
UV-303 90 mm spread, rigid
 McCulloch Lumbar Spine Retractor Tray
UV-304 Tray 265 x 265 mm for Container (not illustrated)



UV-317 - 322
UV-317 20 x 30 mm
UV-318 20 x 40 mm
UV-319 20 x 50 mm
UV-320 20 x 60 mm
UV-321 20 x 70 mm
UV-322 20 x 80 mm
 McCulloch 2-teeth
 Thin Muscle Blades



UV-323 - 330
UV-323 20 mm
UV-324 30 mm
UV-325 40 mm
UV-326 50 mm
UV-327 60 mm
UV-328 70 mm
UV-329 80 mm
UV-330 90 mm
 McCulloch Hook Blades



UV-331 - 338
UV-331 20 mm
UV-332 30 mm
UV-333 40 mm
UV-334 50 mm
UV-335 60 mm
UV-336 70 mm
UV-337 80 mm
UV-338 90 mm
 McCulloch toothed
 Hook Blades



UV-339 - 341
UV-339 20 x 50 mm
UV-340 20 x 60 mm
UV-341 20 x 70 mm
 McCulloch 2-teeth
 Cervical Blades



CASPAR
UV-342 - 343
 Caspar Vertebral Column Retractor for Laminectomy and Hemilaminectomy (Lumbar, Thoracic, Cervical), stainless steel, complete set, 145 mm spread,
UV-342 125 mm arms, consisting of
UV-343 145 mm spread, hinged includes Screw Driver for spreading bar



CASPAR
UV-344
 Screw driver four spreading bar



CASPAR
UV-345
 Blade Changing Forceps 115 mm



UV-346 - 347
UV-346 38 mm
UV-347 58 mm



UV-348 - 355
UV-348 22 x 32 mm
UV-349 22 x 37 mm
UV-350 22 x 43 mm
UV-351 22 x 47 mm
UV-352 22 x 52 mm
UV-353 22 x 57 mm
UV-354 22 x 62 mm
UV-355 22 x 67 mm



UV-356 - 363
UV-356 37 x 32 mm
UV-357 37 x 37 mm
UV-358 37 x 43 mm
UV-359 37 x 47 mm
UV-360 37 x 52 mm
UV-361 37 x 57 mm
UV-362 37 x 62 mm
UV-363 37 x 67 mm



UV-364 - 371
UV-364 57 x 32 mm
UV-365 57 x 37 mm
UV-366 57 x 43 mm
UV-367 57 x 47 mm
UV-368 57 x 52 mm
UV-369 57 x 57 mm
UV-370 57 x 62 mm
UV-371 57 x 67 mm

RETRACTORS FOR CERVICAL VERTEBRAL COLUMN



**CASPAR
UV-372**
Distractor only for use in surgical procedures from the left approach the right approach for the upper cervical spine Distractor as above but with elongated toothed bar for multilevel (more than 2) distraction

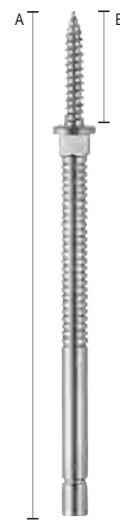

**DISTRACTION PIN A/B
UV-373 - 376**
UV-373 66/12 mm
UV-374 68/14 mm
UV-375 70/16 mm
UV-376 72/18 mm



**TWIST DRILL
UV-377**



**DRILL GUIDE
UV-378**



**SCREW DRIVER
UV-379**



**CASPAR
UV-380**
Distractor only for use in surgical procedures from the left approach the right approach for the upper cervical spine Distractor as above but with elongated toothed bar for multilevel (more than 2) distraction

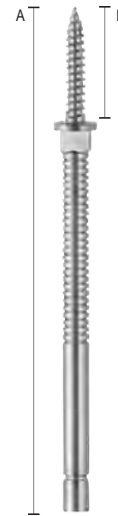

**DISTRACTION PIN A/B
UV-381 - 384**
UV-381 66/12 mm
UV-382 68/14 mm
UV-383 70/16 mm
UV-384 72/18 mm



**TWIST DRILL
UV-385**



**DRILL GUIDE
UV-386**



**SCREW DRIVER
UV-387**



RETRACTORS FOR CERVICAL VERTEBRAL COLUMN



CLOWARD-TYPE
UV-388
Vertebra Spreaders
130 mm
18 mm spread



UV-389
one pointed tip
70 mm
arm, 80 mm spread

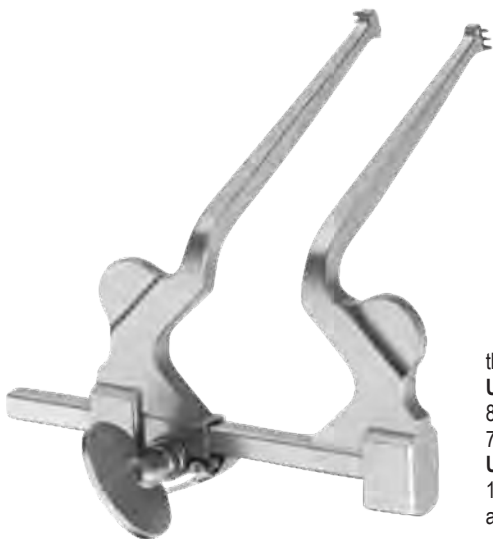

three pointed tips
UV-390
850 mm arm,
70 mm spread
UV-391
100 mm
arm, 70 mm spread



INGE
Lamina Spreaders
UV-392 - 393
UV-392 165 mm
UV-393 270 mm

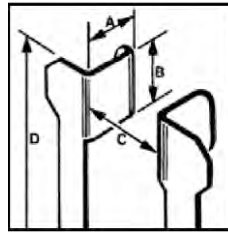

SCOVILLE-HAVERFIELD

	A	B	C	D
UV-394	50 mm	35 mm	140 mm	140 mm
	50 mm			
with 1 each blade 29-3165.50 and 29-3162.51				
Frame only, hinged:				
UV-395			140 mm	140 mm



- Toothed:**
UV-402 - 407
UV-402 63 mm x 26 mm
UV-403 66 mm x 30 mm
UV-404 89 mm x 26 mm
UV-405 51 mm x 51 mm
UV-406 63 mm x 51 mm
UV-407 76 mm x 51 mm



3-prongs:
UV-396 44 mm x 38 mm

4-prongs:
UV-397 - 401
UV-397 41 mm x 38 mm
UV-398 66 mm x 48 mm
UV-399 48 mm x 51 mm
UV-400 63 mm x 63 mm
UV-401 82 mm x 58 mm



Hook-shaped, blunt:
UV-408 - 409
UV-408 50 mm
UV-409 75 mm



RETRACTORS FOR CERVICAL VERTEBRAL COLUMN



Williams
UV-410
for microsurgical treatment
of herniated discs
170 mm
w = 10 mm
UV-411 10 x 50 mm
UV-412 10 x 60 mm
UV-413 10 x 70 mm

w = 20 mm
UV-414 20 x 50 mm
UV-415 20 x 60 mm
UV-416 20 x 70 mm



Williams
UV-417
for microsurgical treatment
of herniated discs
170 mm
w = 10 mm
UV-418 10 x 50 mm
UV-419 10 x 60 mm
UV-420 10 x 70 mm

w = 20 mm
UV-421 20 x 50 mm
UV-422 20 x 60 mm
UV-423 20 x 70 mm



CLOWARD-TYPE

UV-424

with slide lock Cervical Retractor Set with slide-lock complete with 14 blades, 25 cm

UV-425 – UV-426

UV-427 Retractor Body only (without blades), 25 cm



UV-428

Cervical Retractor Set with slide-lock complete with 14 blades, 16 cm

UV-429 – UV-430

UV-431 Retractor Body only (without blades), 160 mm



UV-432 - 438

UV-432 25 mm

UV-433 30 mm

UV-434 35 mm

UV-435 40 mm

UV-436 45 mm

UV-437 50 mm

UV-438 55 mm

blunt



UV-439 - 445

UV-439 25 mm

UV-440 30 mm

UV-441 35 mm

UV-442 40 mm

UV-443 45 mm

UV-444 50 mm

UV-445 55 mm

blunt



SKULL INSTRUMENTS

Galea Hooks



YASARGIL
UV-446
31 cm

YASARGIL
UV-447
41 cm

Dura Protecting Forceps

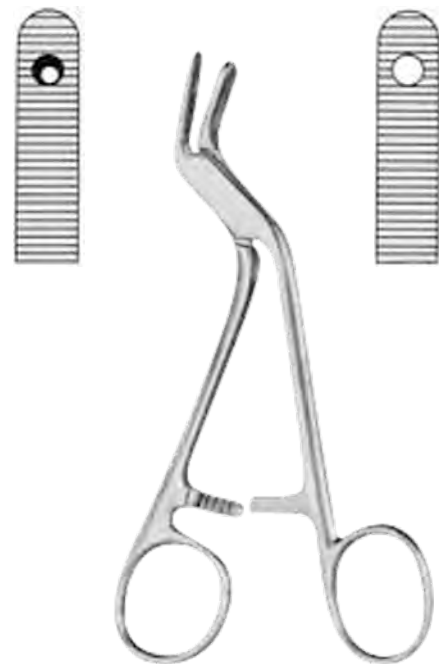

ADSON
UV-448
15 cm



UV-449
Silver Wires Mckenzie

Elio Carrier



MCKENZIE
UV-450
148x40x60 mm
One Clip Holding



MCKENZIE
UV-451
190x48x13 mm
Two Clips Holding

Silver Clips



UV-452



LEYLA FIXATION SYSTEM (YASARGIL)

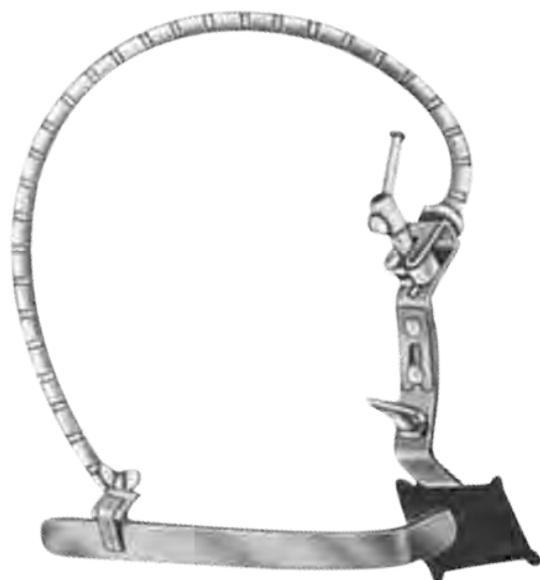

UV-453
Complete Brain Ttractor
Set With 1 Arm



UV-455
Complete Set

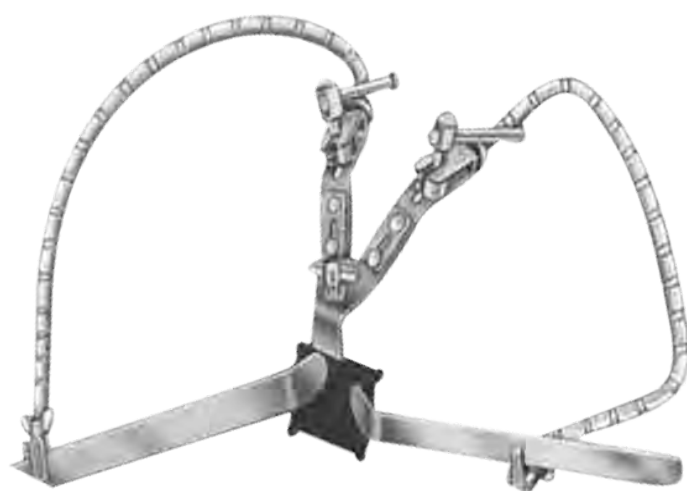

UV-454
Complete Brain Ttractor
Set With 2 Arm



UV-456
Ball and Socket Joint



UV-457
Holding Rod, Head



UV-458
Coupling Head



UV-459
Fixation Base for skull
Mounting Holding 1
Flexible Arm



UV-460
Fixation Base for skull
Mounting, Holding 2
Flexible Arms



UV-461
Fixation Base for
Mounting to 16 mm Dia.
Holding 1 Flexible Arm

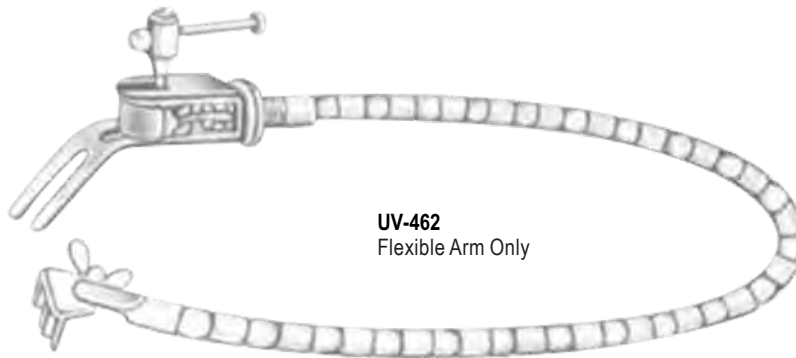

UV-462
Flexible Arm Only



UV-463
Support for Flat
Brain Spatula



UV-464
Support for Brain Spatula
With Round Shaft



UV-465
Handed for Ear Spatula



NERVE AND DURA HOOKS



Smithwick
UV-466
29 cm
Dura Dissector



Smithwick
UV-467 - 468
Nerve hook



Hoen
UV-469
22 cm 11 mm



Dandy
UV-470
20 cm 4.0 mm



Dandy
UV-471
20 cm 4.0 mm



Dandy
UV-472
20 cm 4.0 mm



Adson
UV-473 - 474



Graham
UV-475 - 476



Sachs
UV-477
17 cm



Crile
UV-478 - 479

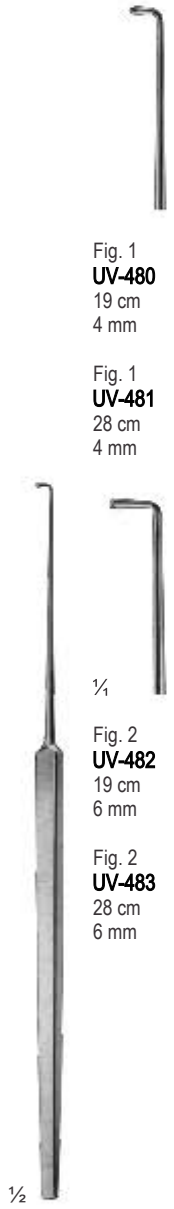

Cushing
UV-480 - 481
UV-482 - 483

Fig. 1
UV-480
19 cm
4 mm

Fig. 1
UV-481
28 cm
4 mm

Fig. 2
UV-482
19 cm
6 mm

Fig. 2
UV-483
28 cm
6 mm



NERVE AND DURA HOOKS



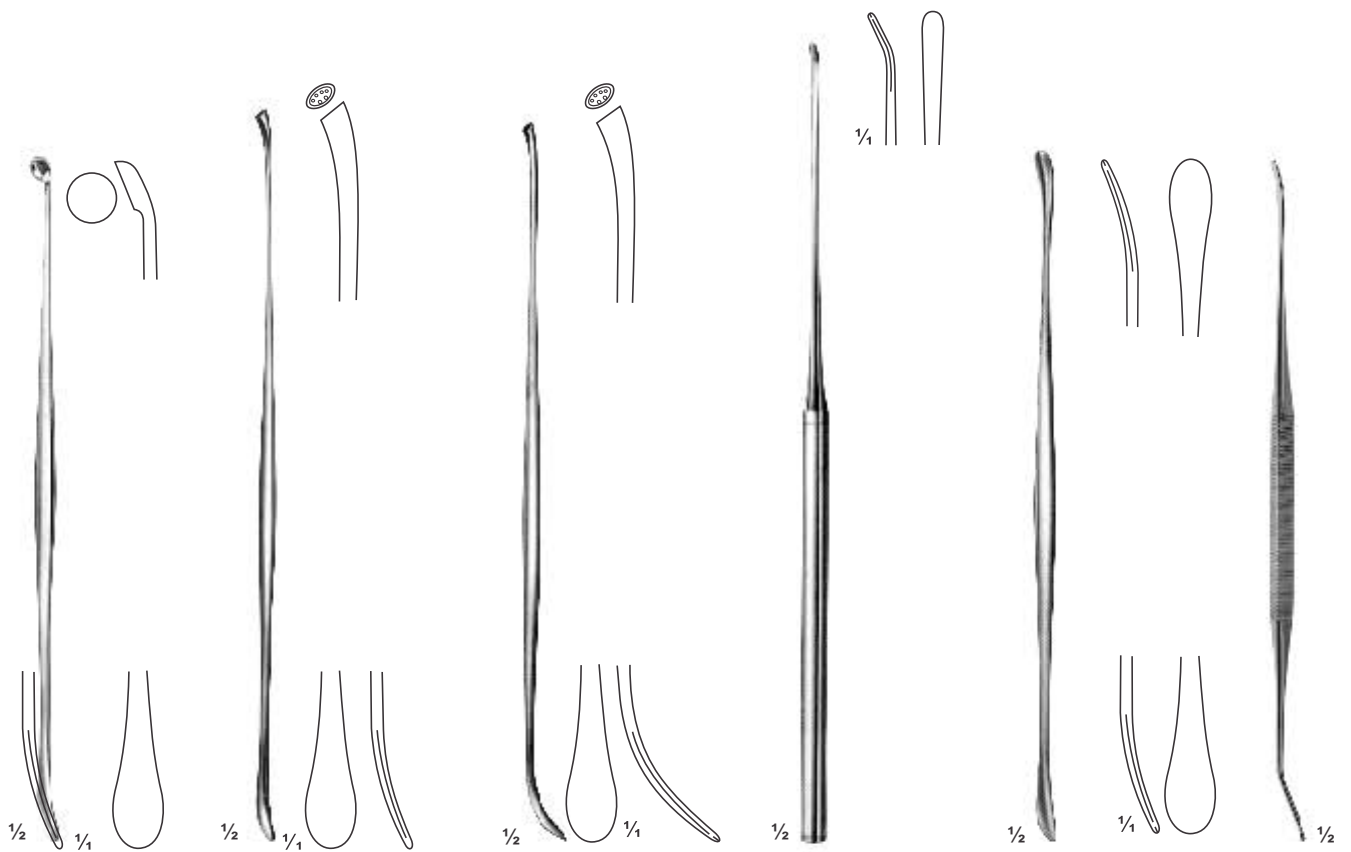

Fig. 1
Penfield
UV-490
17.5 cm
Dura dissectors

Fig. 2
Penfield
UV-491
19.5 cm
Dura dissectors

Fig. 3
Penfield
UV-492
19.5 cm
Dura dissectors

Fig. 4
Penfield
UV-493
20.5 cm
Dura dissectors

Fig. 5
Penfield
UV-494
18.5 cm
Dura dissectors

Watson-Cheyne
UV-495
18 cm
Dissectors