

Page 01-17

- Micro Instruments



WX-001



WX-002



WX-003

WX-001 - 003
VANNAS
85 mm



WX-004



WX-005

WX-004 - 005
CASTROVIEJO
95 mm

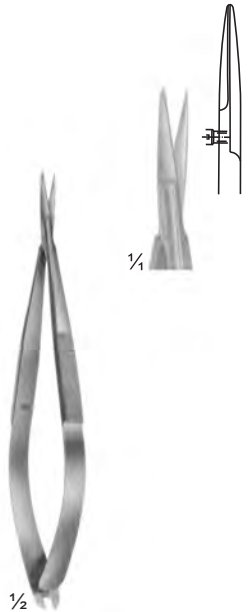

WX-006
NOYES
125 mm

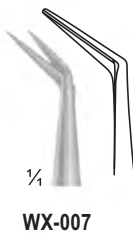
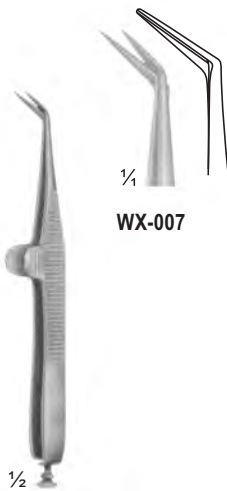

WX-007



WX-008

WX-007 - 008
WECKER
Eye Scissor
110 mm

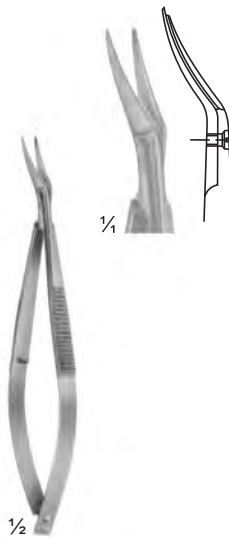

WX-009

WX-009
CASTROVIEJO
Eye Scissor
115 mm



WX-010

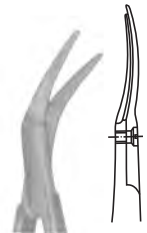

WX-011

WX-010 - 011
CASTROVIEJO
Eye Scissor
110 mm



MICRO SCISSORS “SPRING TYPE” FLAT HANDLES

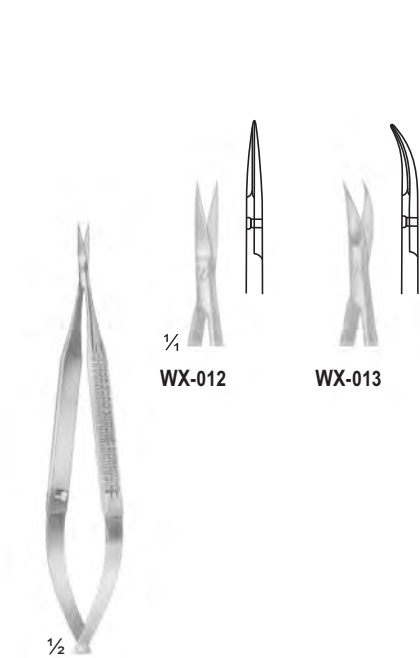

WX-012 - 013
120 mm

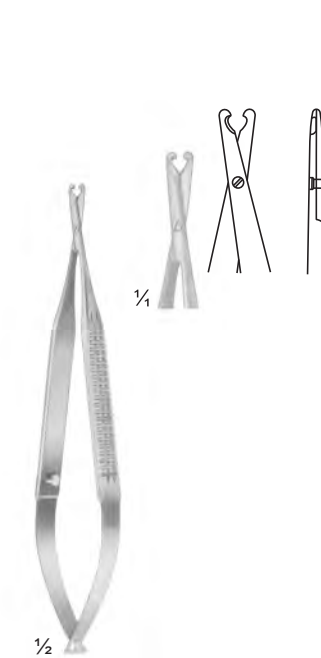

WX-014
BIEMER
Vein Scissor
130 mm

WX-015
160 mm

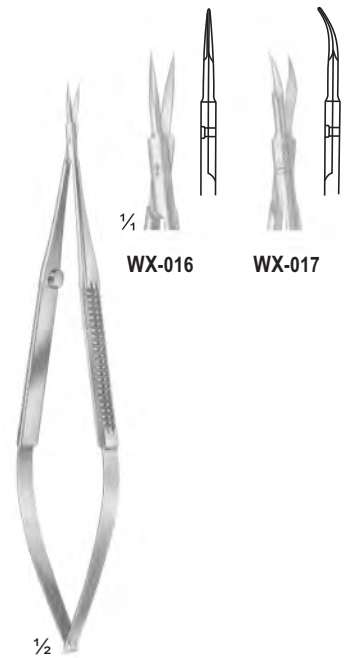

WX-016 - 017
VANNAS
160 mm

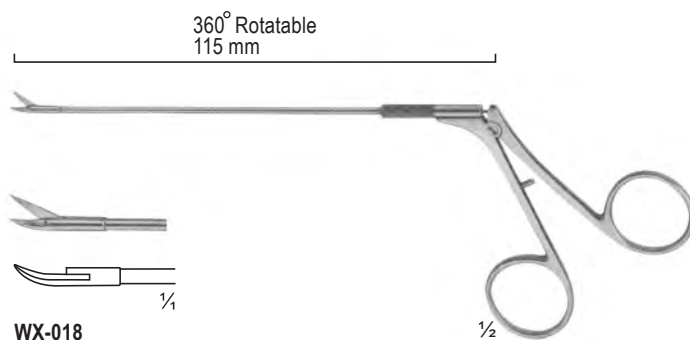

WX-018
CASPAR
Micro Scissor Curved
115 mm



WX-019

WX-020

WX-021



WX-019 - 021
Micro Dissecting Scissor
145 mm

MICRO SCISSORS "SPRING TYPE" BAYONET SHAPE



1/4



1/2

WX-022
YASARGIL
245 mm



1/4

WX-023



1/2

WX-023 - 024
Laterally Angled
200 mm



1/4

WX-024



1/2

WX-025
Laterally Angled
190 mm

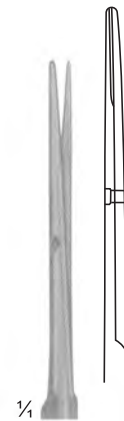

1/4

WX-026



1/2

WX-026 - 027
YASARGIL
225 mm

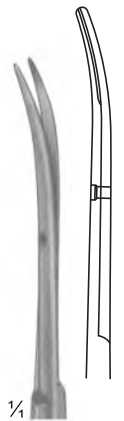

1/4

WX-027

MICRO SPRING SCISSORS



WX-028 - 029
CASTROVIEJO
Spring Scissors
15, 18 cm

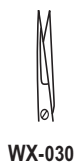

WX-030 - 032
STREAMLINE
Micro Coronary
Scissors
15, 18, 21, 23 cm

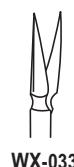

WX-033
STREAMLINE
Spring Scissors
23 cm



WX-034 - 035
STREAMLINE
Spring Scissors
23 cm



WX-036 - 037
TOLEDO
Spring Scissors
16.5 cm



WX-038 - 039
BARRAQUER
Spring Scissors
12, 15, 18 cm

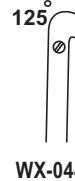
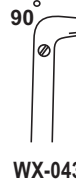

WX-040 - 044
BARRAQUER
Spring Scissors
18 cm

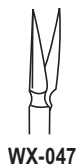

WX-045 - 047
BARRAQUER
Spring Scissors
Bayonet
22 cm

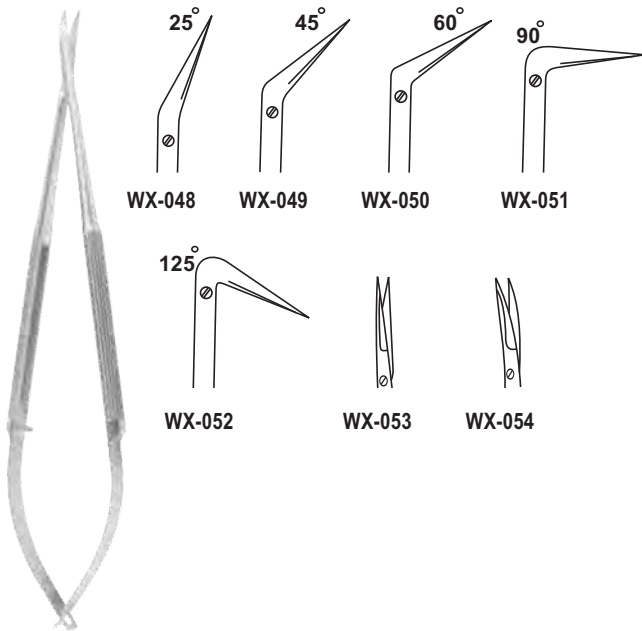

WX-048

WX-049

WX-050

WX-051

WX-052

WX-053

WX-054

WX-048 - 054
STREAMLINE
Spring Scissors
18, 21 cm



WX-055
ONG-TREUMER
Capsulotomy Scissors
8 cm



WX-056
VANNAS-TUBINGEN
After-Cataract Scissors
8 cm
8 mm



WX-057
WESTCOTT
Tenotomy Scissors
11 cm



WX-058
WESTCOTT
Micro-Tenotomy
Scissors
10.5 cm



WX-059
Micro Spring
Scissors
10.5 cm
12 mm



WX-060
CASTROVIEJO
Corneal Scissors
10.5 cm



WX-061
TROUTMAN
Corneal Scissors
10 cm

SCISSORS AND MICRO FORCEPS



WX-062
BONN
Eye Scissors
9 cm



WX-063
Eye Scissors
10.6 cm

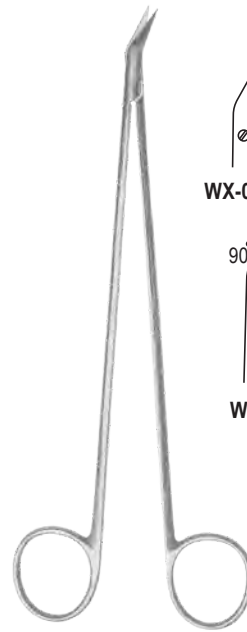

WX-064 - 068
HEGEMANN
Ring Scissors
18 cm

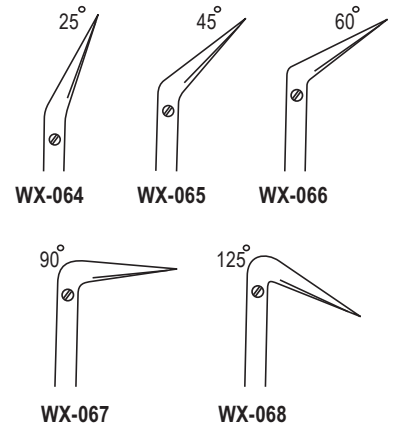

WX-069 - 073
TOLEDO
Forceps Heavy
18, 21 cm

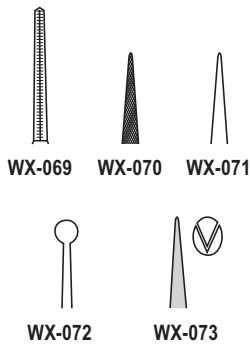

WX-074 - 078
Forceps
15, 18 cm

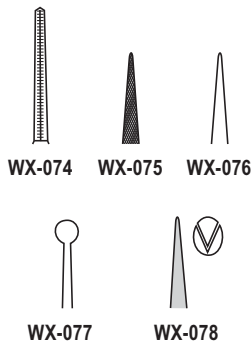

WX-079 - 083
TOLEDO
Forceps
18, 21 cm

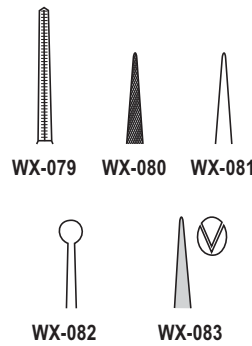

WX-084 - 088
15, 18, 21 cm

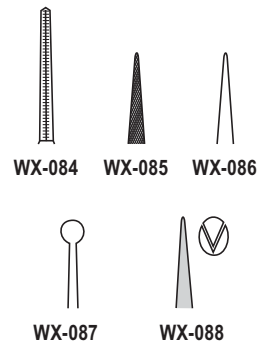



WX-089 - 093
Forceps
15, 18, 21 cm

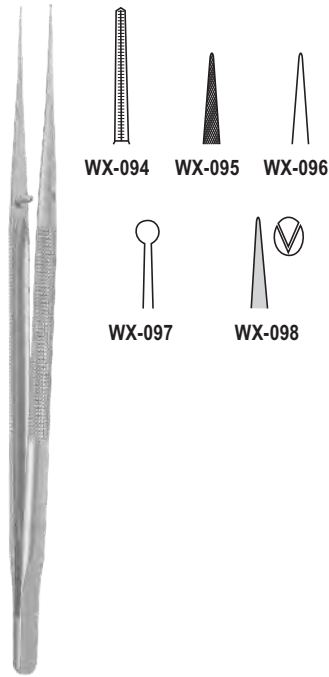

WX-094 - 098
15, 18, 21 cm

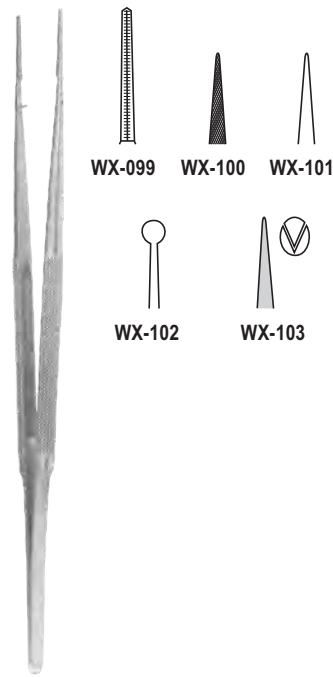

WX-099 - 103
Forceps
15, 18, 21 cm

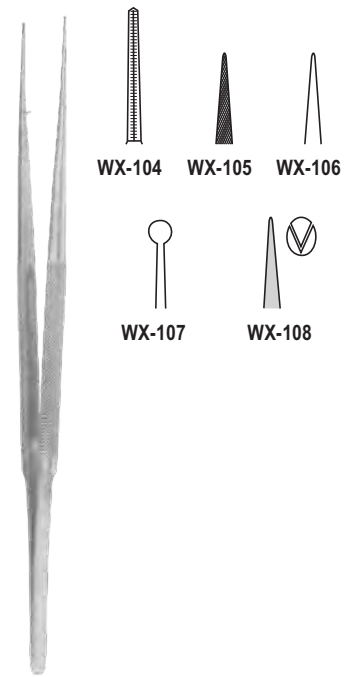

WX-104 - 108
Forceps
15, 18, 21 cm

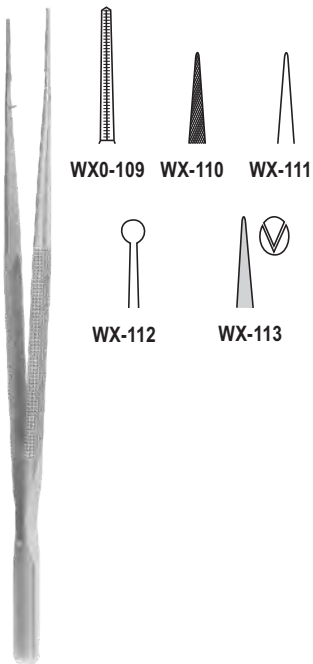

WX-109 - 113
Forceps Counter
Balance
15, 18, 21 cm

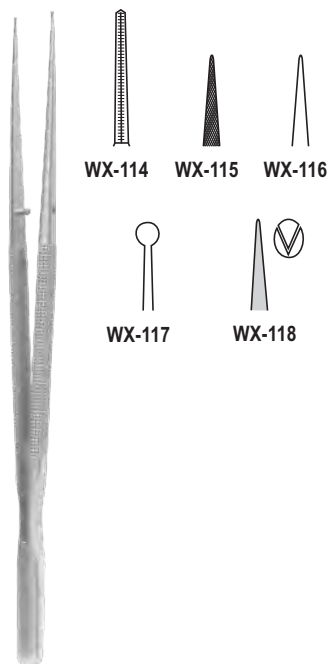

WX-114 - 118
Forceps Counter
Balance
15, 18, 21,
23, 25 cm

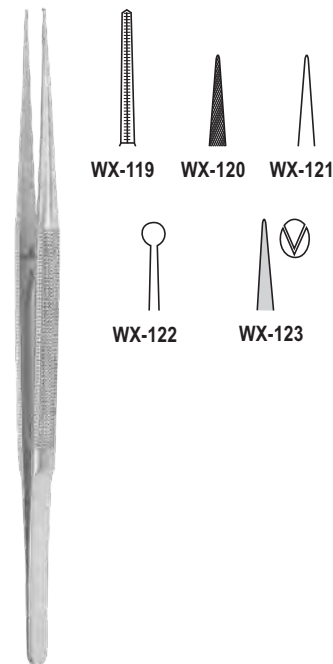

WX-119 - 123
Forceps
15, 21, 23 cm

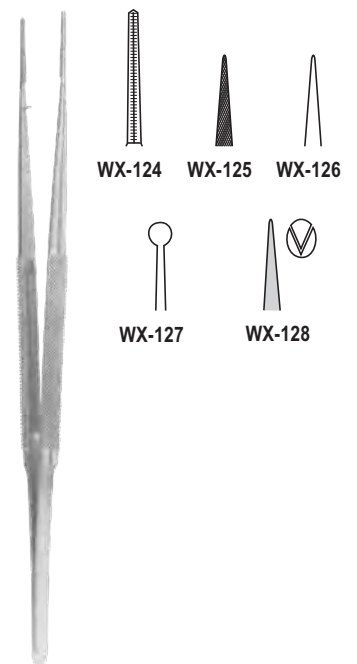

WX-124 - 128
Forceps
18, 21 cm

DELICATE TISSUE FORCEPS

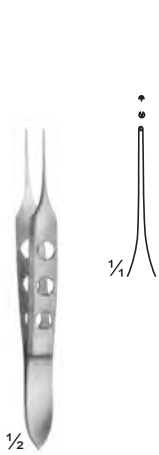

BISHOP-HARMON
WX-129
8.5 cm

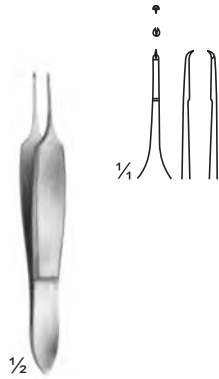

ST. MARTIN
WX-130
8 cm

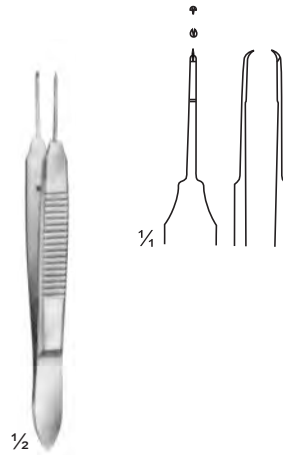

CASTROVIEJO
WX-131
teeth 0.9 mm
10 cm

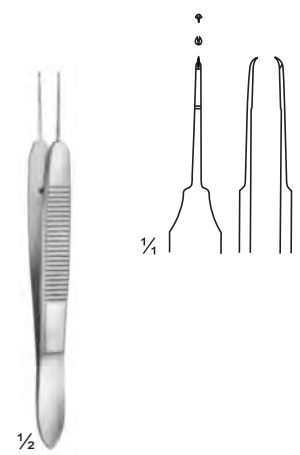

CASTROVIEJO
WX-132
teeth 0.5 mm
10 cm

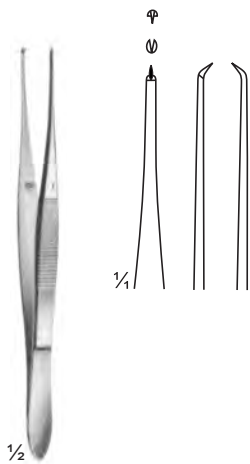

ELSCHING
WX-133
11 cm

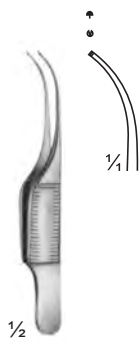

GILL
WX-134
7.5 cm

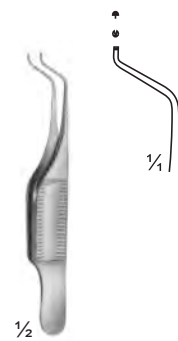

GILL - HESS
WX-135
7.5 cm

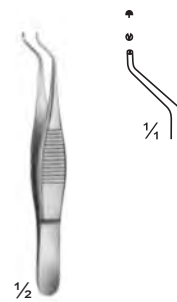

HESS
WX-136
7 cm

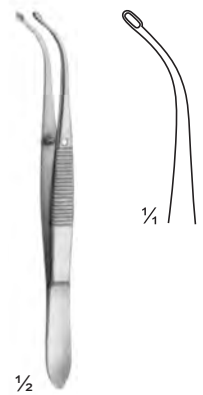

ARRUGA
WX-137
10 cm



WX-138

WX-138
Colibri Forceps With
Tying Platform
8 cm



WX-139
Utility Forceps
10 cm



WX-140

WX-140 - 141
TUBINGEN
Suture Forceps
8.5, 11 cm

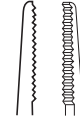

WX-141



WX-142
BONN
Suture Forceps
7.5 cm



WX-143
BONN
Iris Forceps
8 cm



WX-144
McDonalds-Spaleck
Lense Implantation
Forceps Crossaction
10 cm
5, 6 mm



WX-145
FAULKNER
Holding Forceps
10 cm
5, 6, 11 mm



WX-146
Spaleck-microma
Lense Implantation
Forceps
10 cm
5.6, 6.6 mm



MICRO HOOKS, SHARP INSTRUMENTS AND EYE RETRACTOR



WX-147
Hook



WX-148
JAMESON
Strabismus Hook



WX-149
GRAEFE
Strabismus Hook
13, 14 cm



WX-150
GRAEFE
Iris Hook



WX-151
GILLES
Skin Hook



WX-152
GUTHRIE
Fixation Hook,
double



WX-153
MEYHOFER
Spoon



WX-154
KUHN
Corneal Scarifier



WX-155
GRAEFE
Scarifier



WX-156
Foreign Body
Needle



WX-157
HAMBURG
Air Keratome



WX-158
DESMARRES
Eye Retractor



WX-159
BOWMAN
Lachrymal
Probes



WX-160
WILDER
Lachrymal
Probes



WX-161
WEISS
Eye Speculum



WX-162
CASTROVIEJO
Eye Speculum

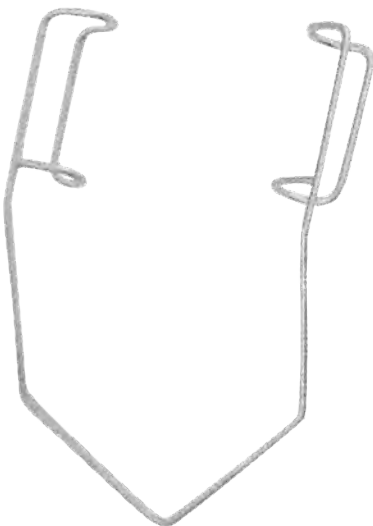

WX-163
BARRAQUER
Eye Speculum

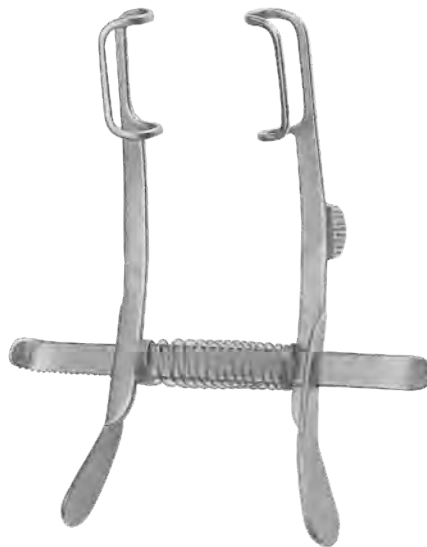

WX-164
MELLINGER
Eye Speculum



WX-165
MINIGOLDSTEIN
Self-Retaining Retactors
3 Teeth
2 cm



SELF RETAINING RETRACTORS



WX-166
ALM
Self-Retaining Retractors
4 Teeth
7 cm



WX-167
ALM
Self-Retaining Retractors
4 Teeth
10 cm



WX-168
HOLTZHEIMER
Self-Retaining Retractors
4 Teeth
10 cm



WX-169
HOLTZHEIMER
Self-Retaining Retractors
4 Teeth
10 cm



WX-170
Cross Action
Forceps
28 mm



WX-171
Cross Action
Forceps
35 mm

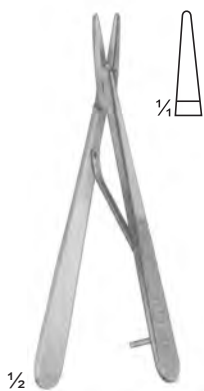

WX-172
ROHRSCHEIDER
With copper inserts
100 mm



WX-173
KALT
With catch
135 mm



WX-174
ARRUGA
With catch
135 mm



WX-175 - 176
CASTROVIEJO
With catch
145 mm



WX-177 - 178
CASTROVIEJO
Without Catch
160 mm



NEEDLE HOLDERS FOR MICRO SURGERY

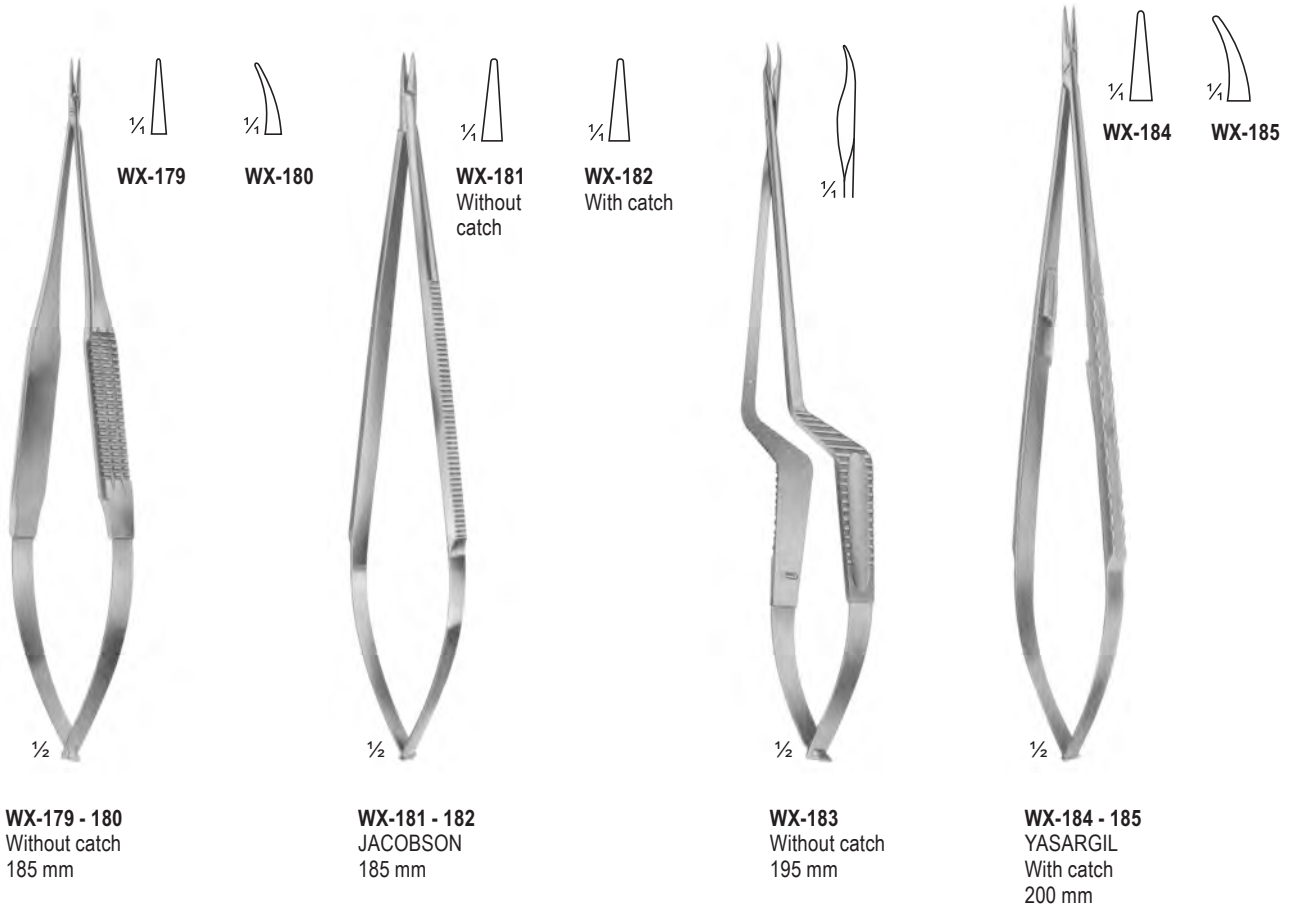



WX-186 - 187
BARRAQUER
Without catch



WX-186
115 mm



WX-187
135 mm

1/2



WX-188 - 189
BARRAQUER
Without catch
120 mm



WX-188



WX-189

1/2



WX-190 - 191
BARRAQUER
Without catch
120 mm



WX-190



WX-191

1/2



WX-192 - 193
BARRAQUER
Without Catch
150 mm



WX-192



WX-193

1/2



MICRO NEEDLE HOLDERS

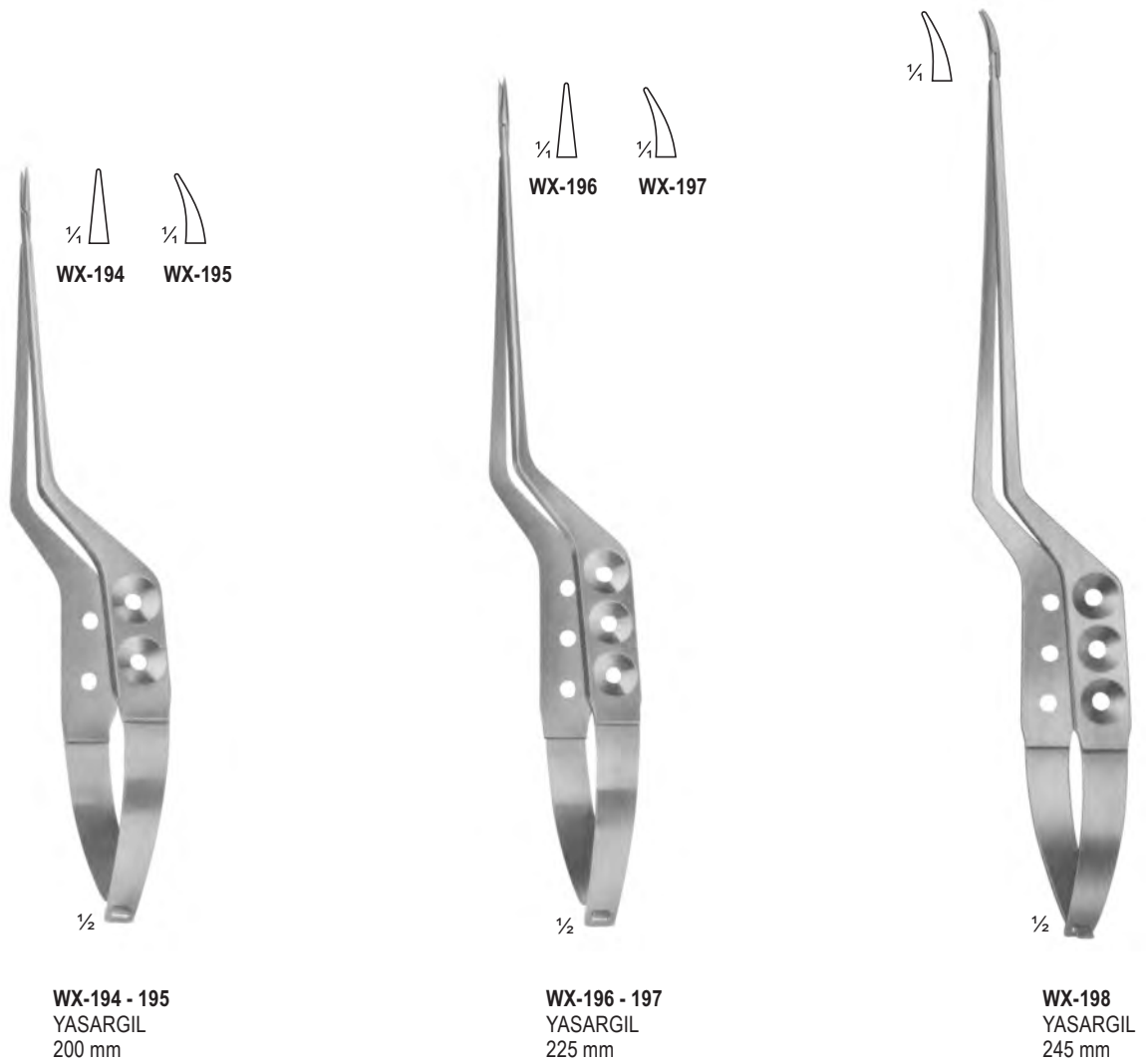

NEEDLE HOLDERS WITH TUNGSTEN CARBIDE INSERTS
MICRO NEEDLE HOLDERS WITH ROUND HANDLES



CASTROVIEJO
WX-199 - 202
145 mm

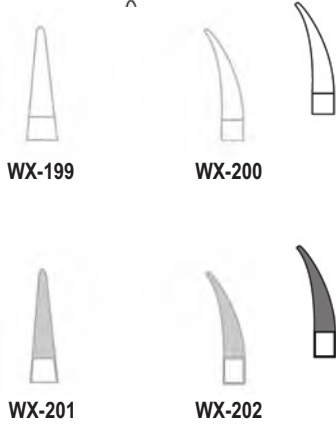

WX-199

WX-200

WX-201

WX-202



CASTROVIEJO
WX-203 - WX-206
180 mm

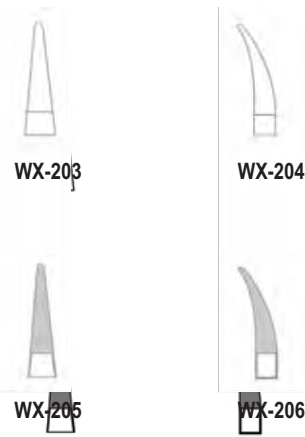

WX-203

WX-204

WX-205

WX-206



BARRAQUER
WX-207 - 210
145 mm

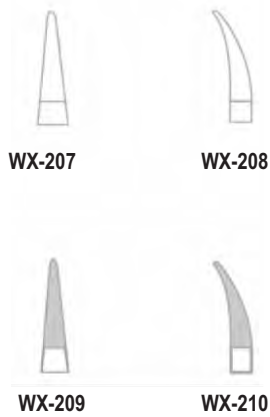

WX-207

WX-208

WX-209

WX-210



HEPP SCHEIDEL
WX-211
180 mm

