

Page 01–29

- Haemostatic Forceps

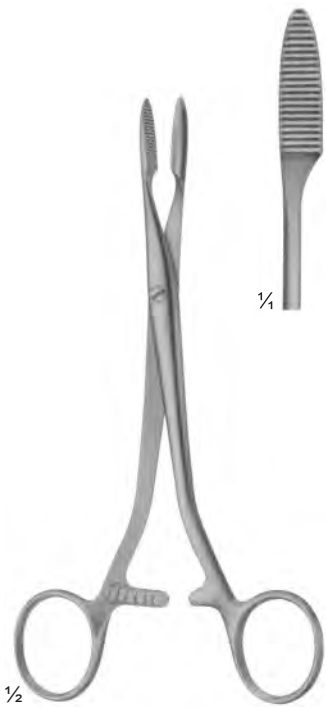

PEAN
DE-001 160 mm
DE-002 180 mm

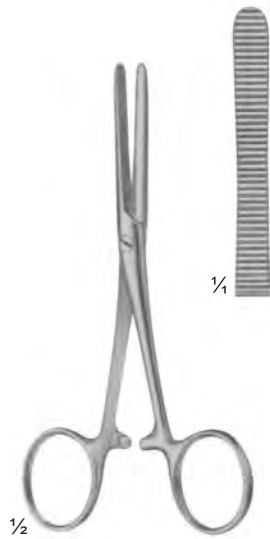

PEAN
DE-003
125 mm



PEAN
DE-004 125 mm
DE-005 140 mm

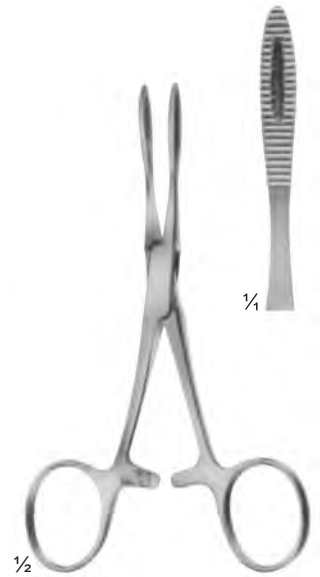

KRONLEIN
DE-006
130 mm



SPENCER-WELLS
DE-007 - DE-013
DE-007 130 mm
DE-008 140 mm
DE-009 150 mm
DE-010 180 mm
DE-011 200 mm
DE-012 250 mm
DE-013 300 mm

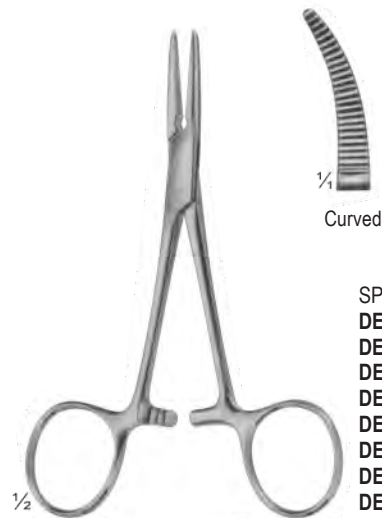

SPENCER-WELLS
DE-014 - DE-020
DE-014 130 mm
DE-015 140 mm
DE-016 150 mm
DE-017 180 mm
DE-018 200 mm
DE-019 250 mm
DE-020 300 mm

DELICATE HAEMOSTATIC FORCEPS

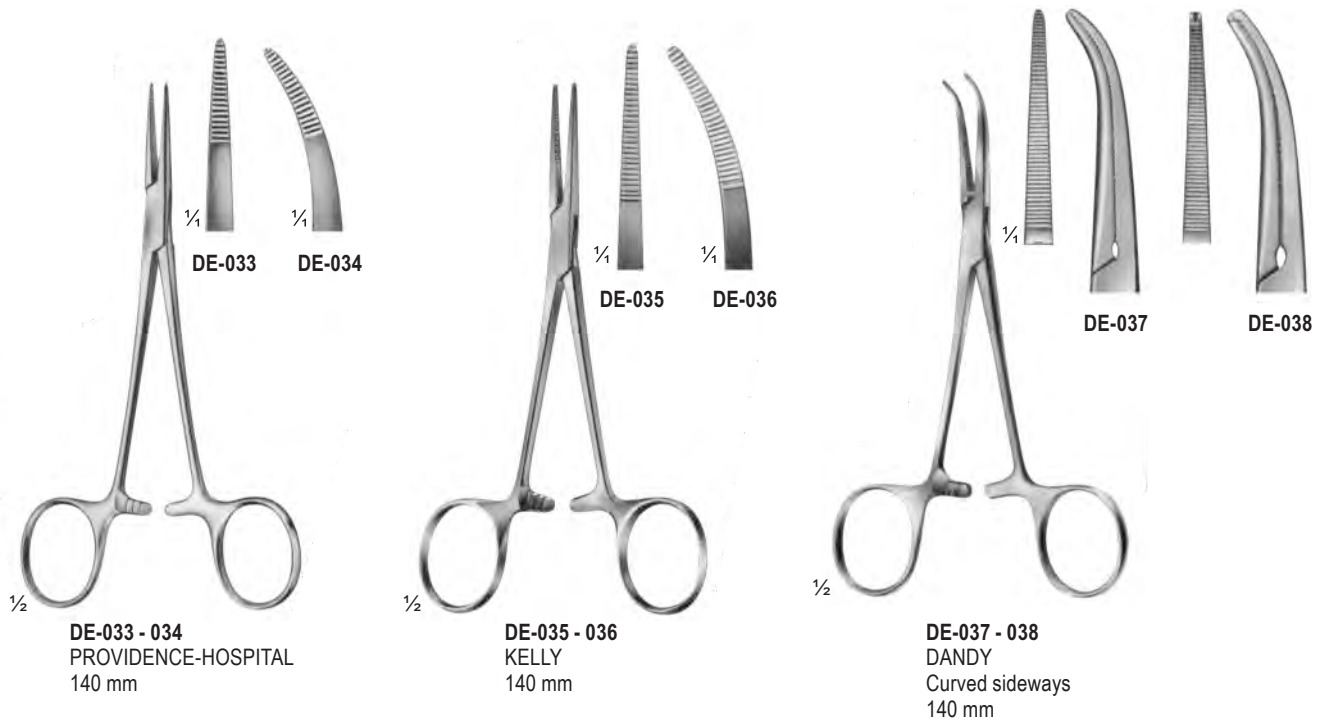
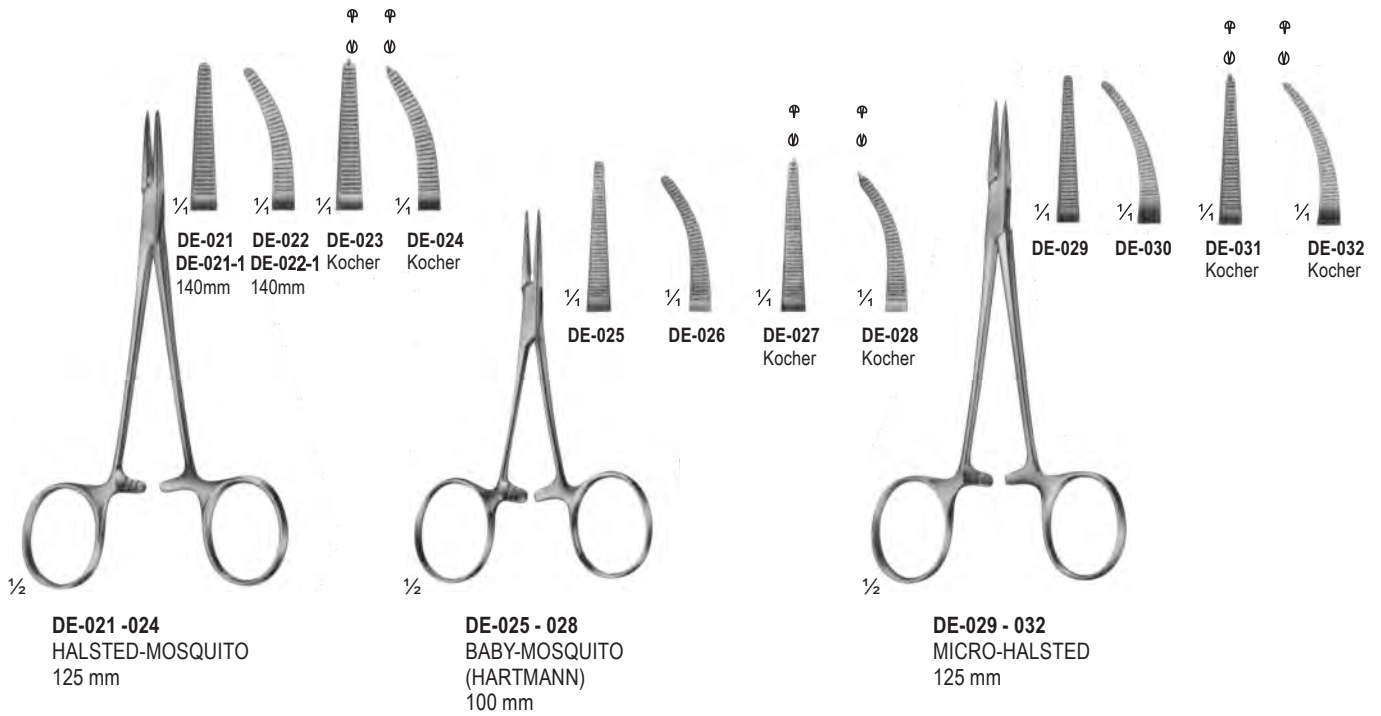

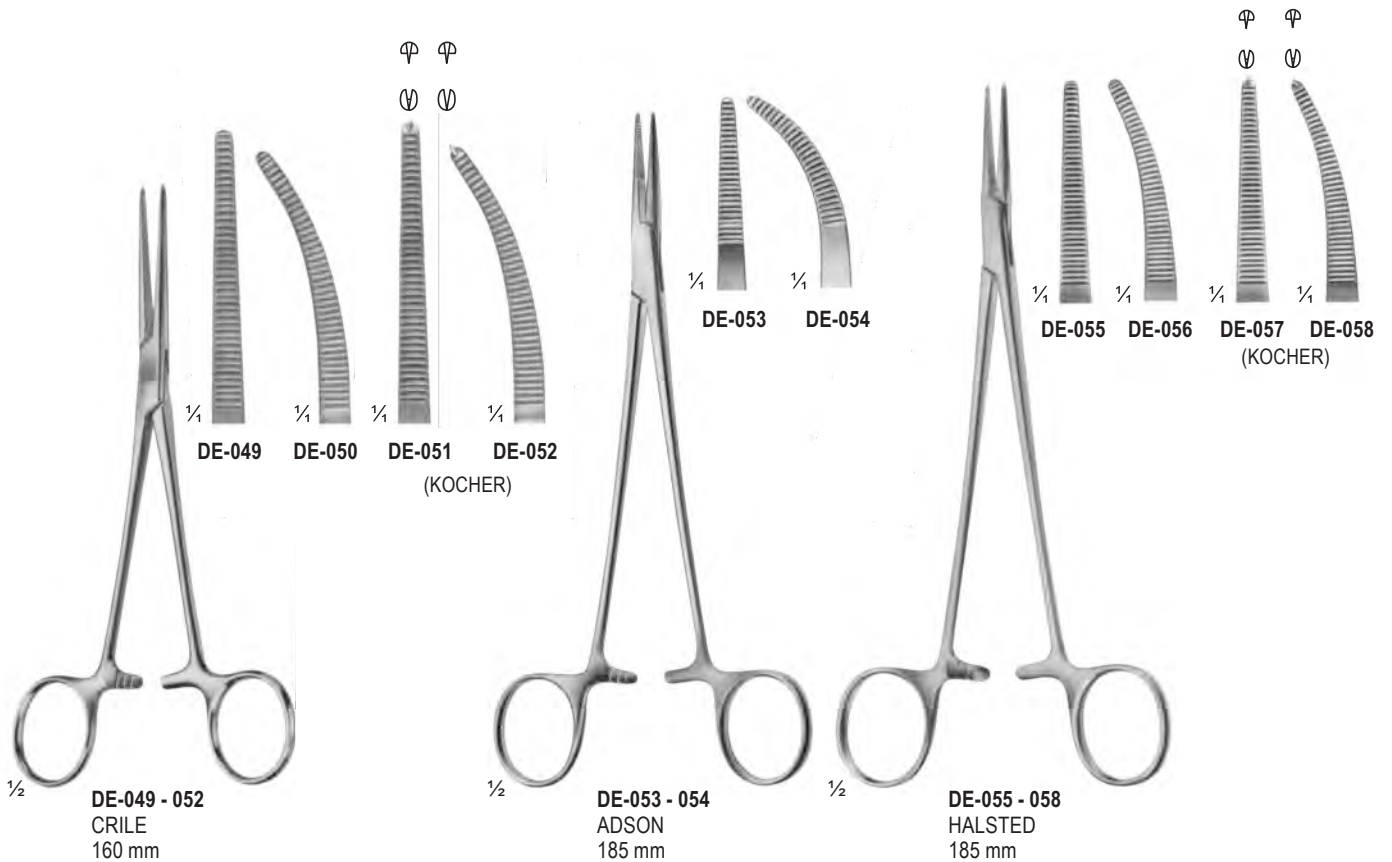
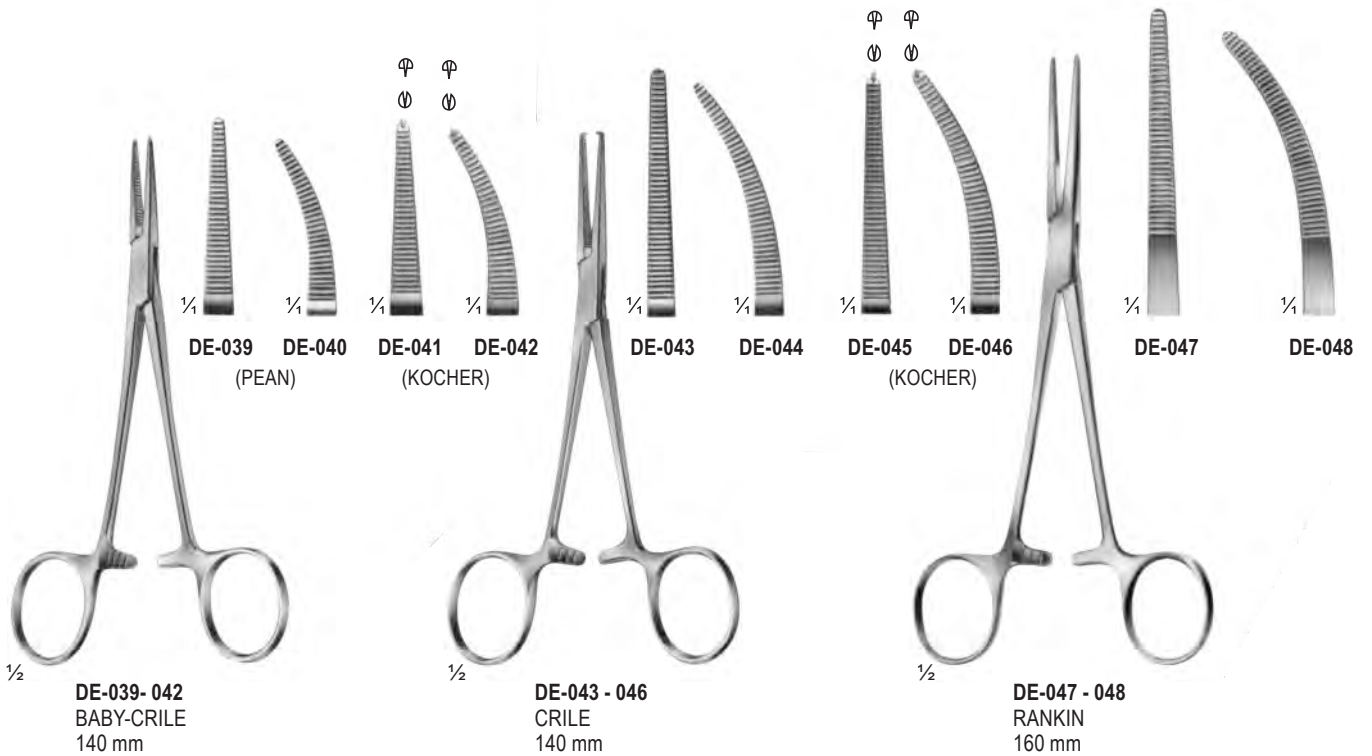



DELICATE HAEMOSTATIC FORCEPS



1/2
DE-059 - 063
HEISS
200 mm

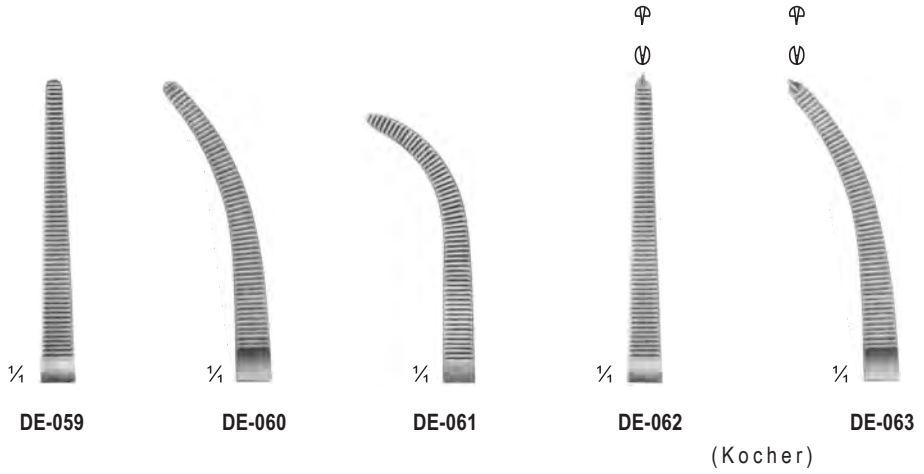

(Kocher)



1/2
DE-064 - 065
HALSTED
215 mm

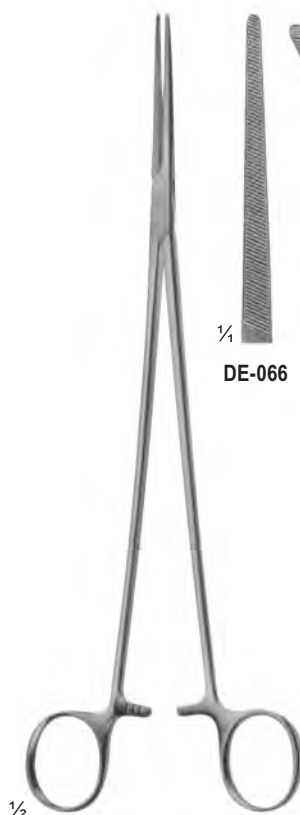
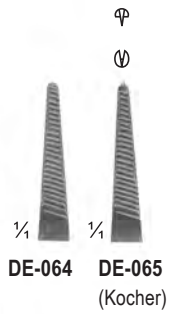

1/2
DE-066 - 069
BENGOLEA
245 mm

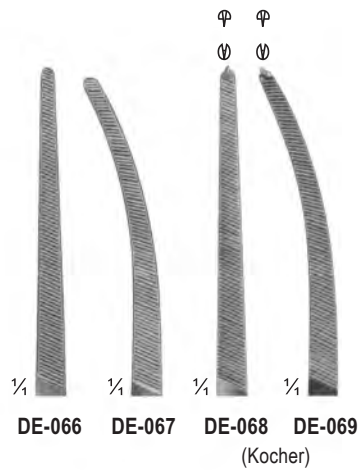

(Kocher)

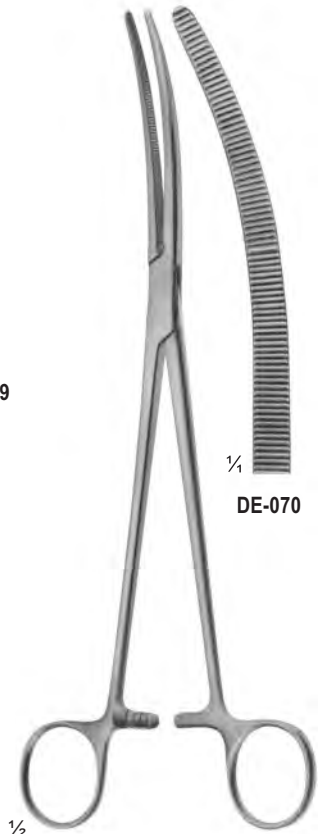

1/2
DE-070
CRAFOORD
245 mm

1/2
DE-070

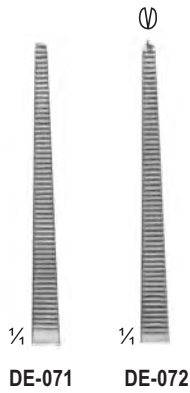

HALSTED-MOSQUITO
DE-071 180 mm
DE-072 210 mm

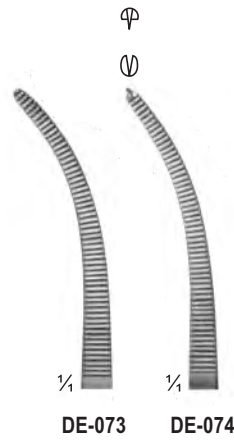

HALSTED-MOSQUITO
DE-073 180 mm
DE-074 210 mm

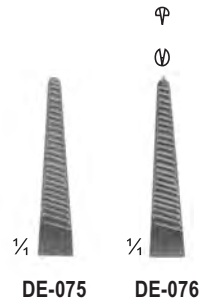

HALSTED
DE-075 - 076
215 mm

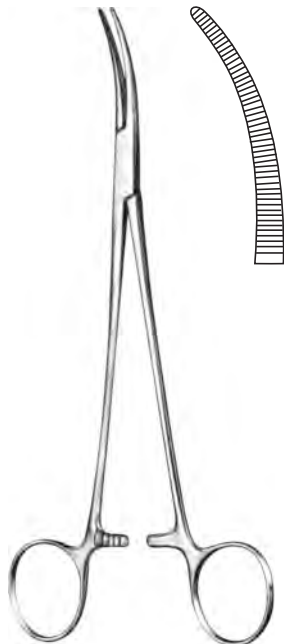

MARTIN-FUCHSIG
DE-077
200 mm

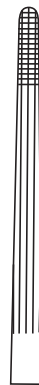

ROCHESTER-CARMALT
DE-078 170 mm
DE-079 200 mm



ROCHESTER-CARMALT
DE-080 160 mm
DE-081 200 mm



HAEMOSTATIC FORCEPS

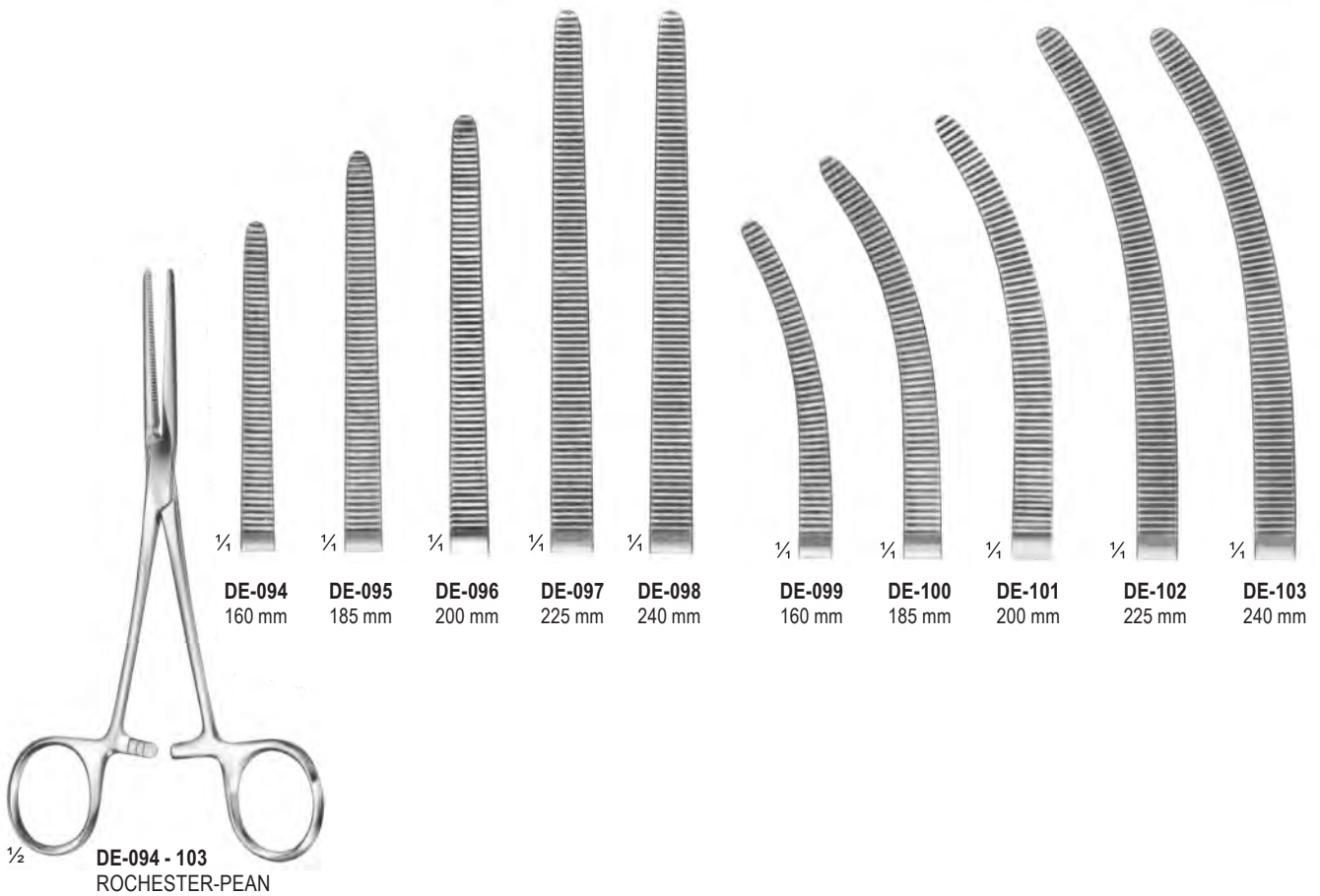
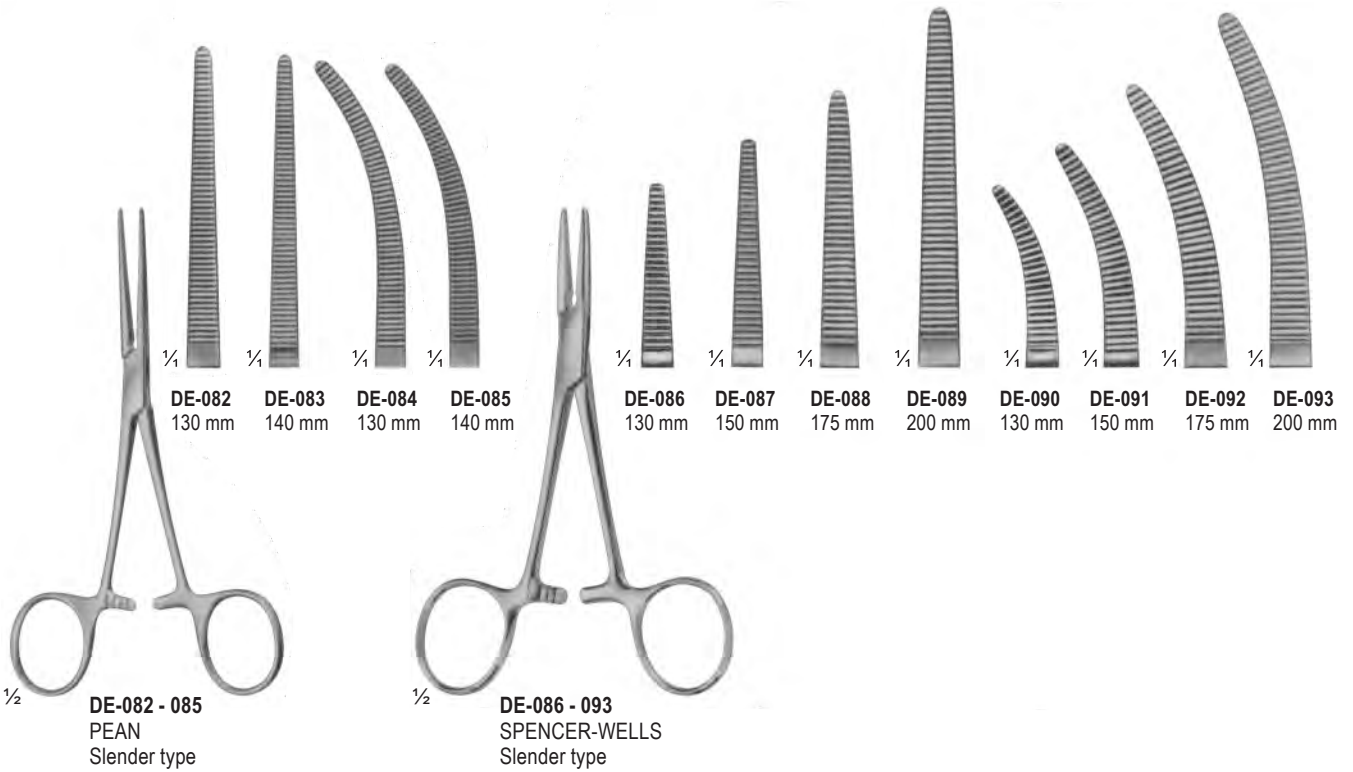

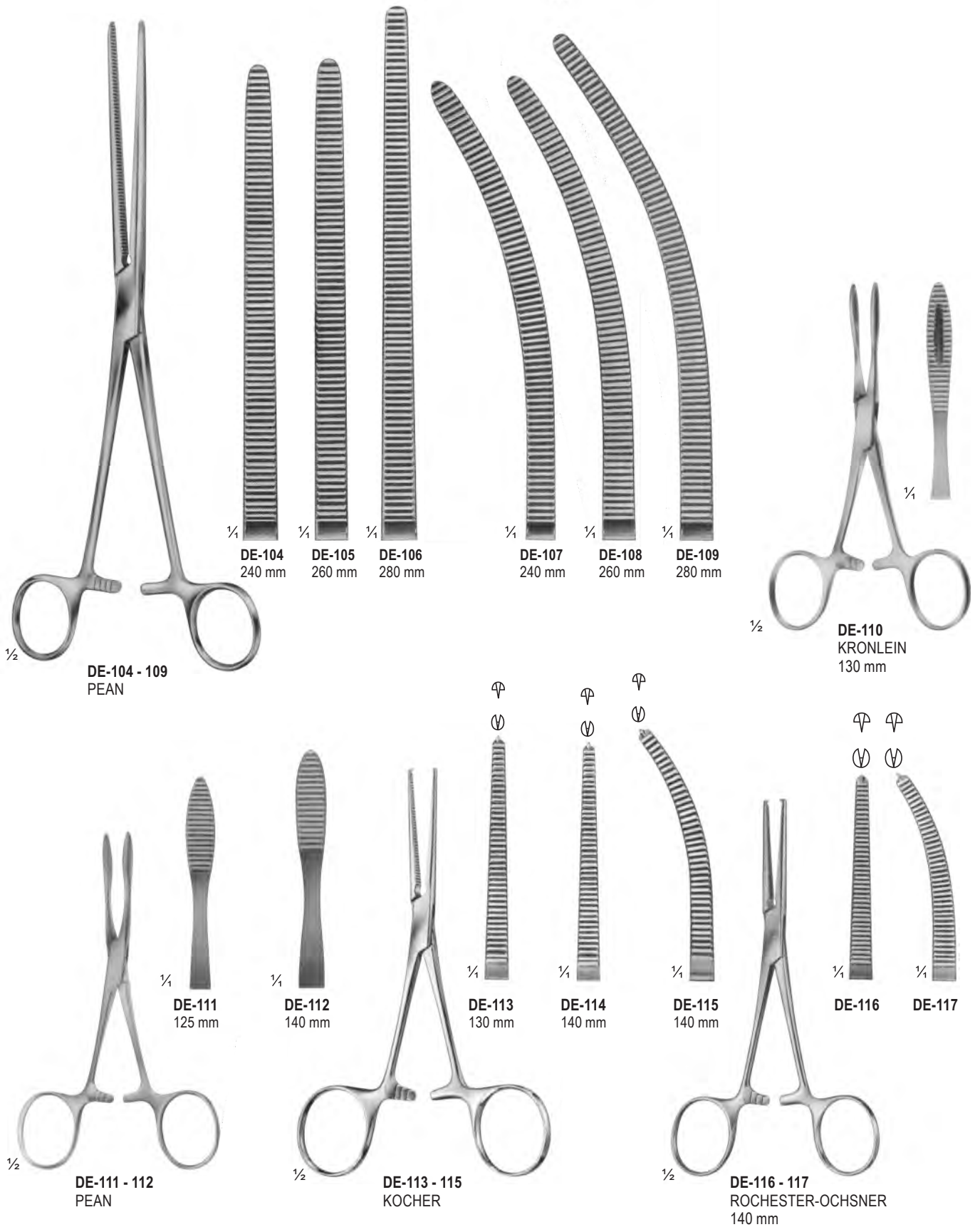



HAEMOSTATIC FORCEPS



1/2 **DE-118 - 123**
KOCHER-OCHSNER (STR)

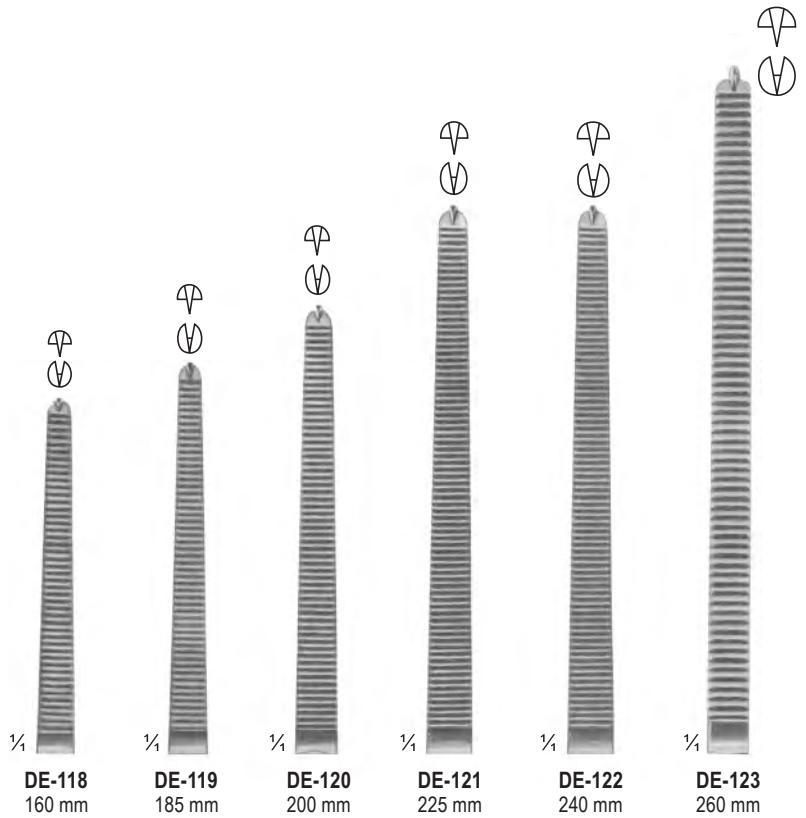

1/2 **DE-124 - 129**
KOCHER-OCHSNER (CVD)

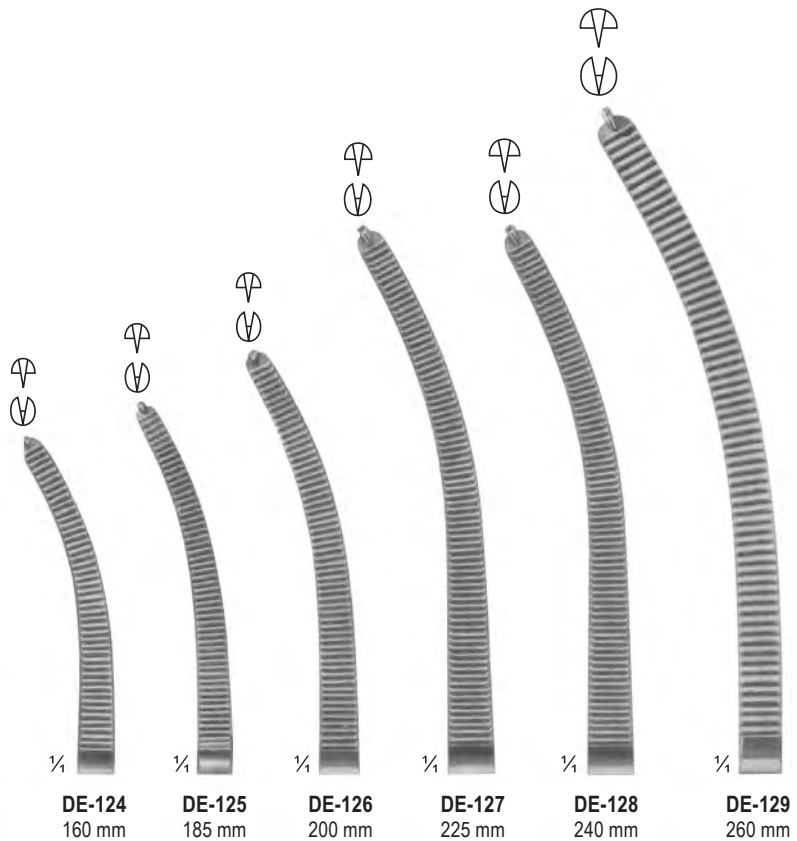

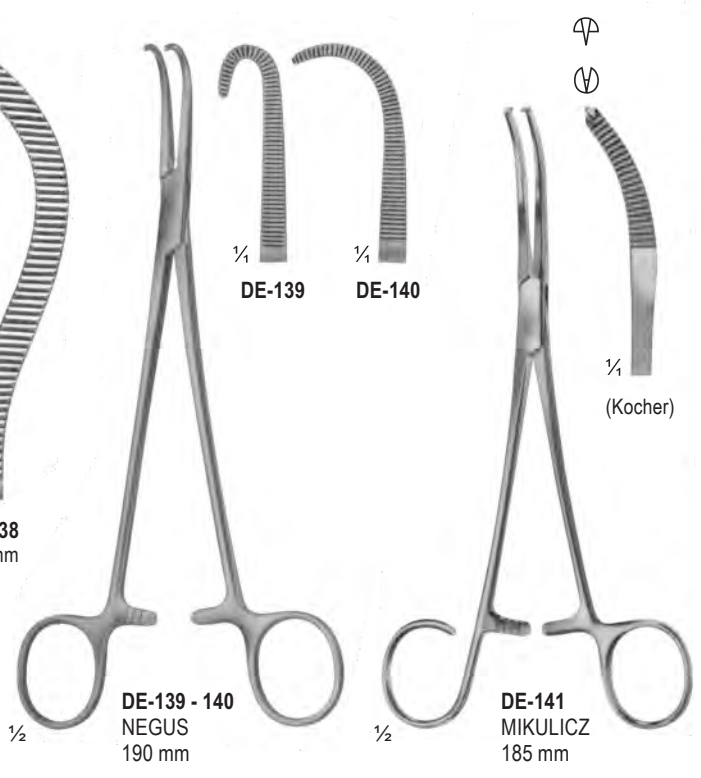
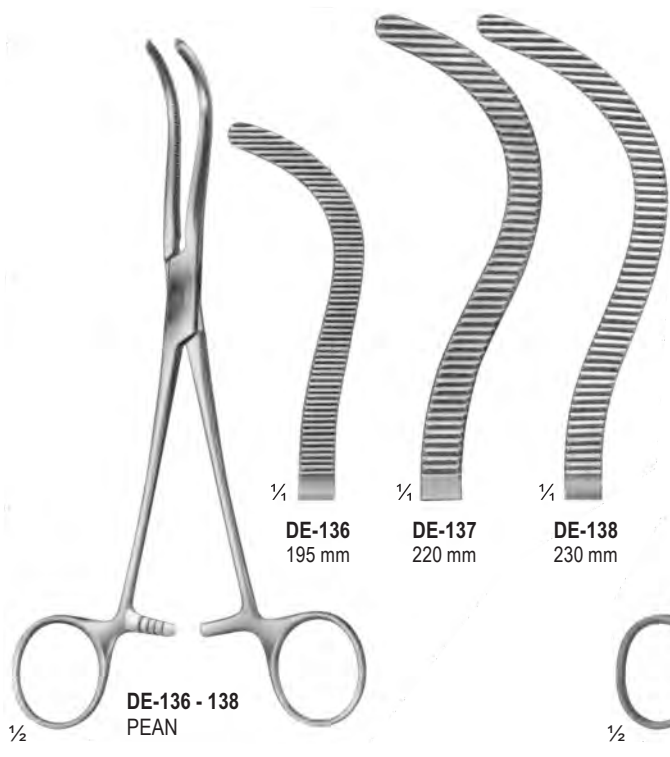
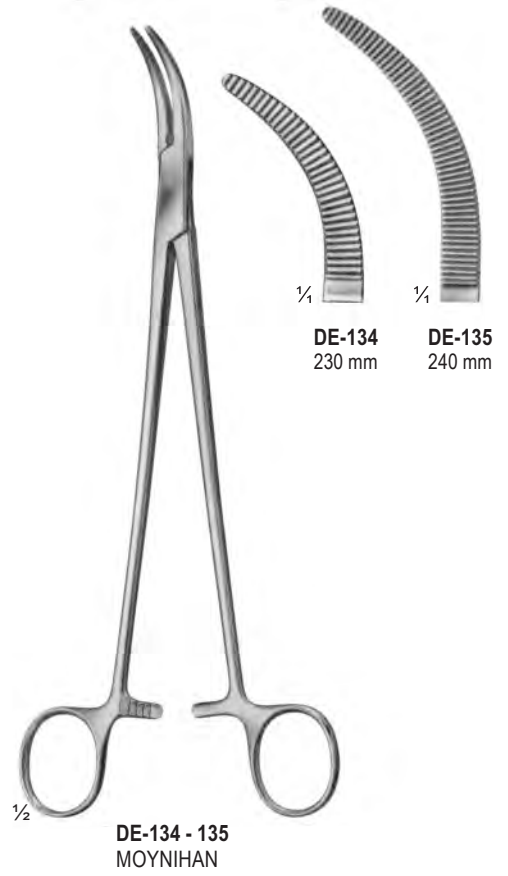
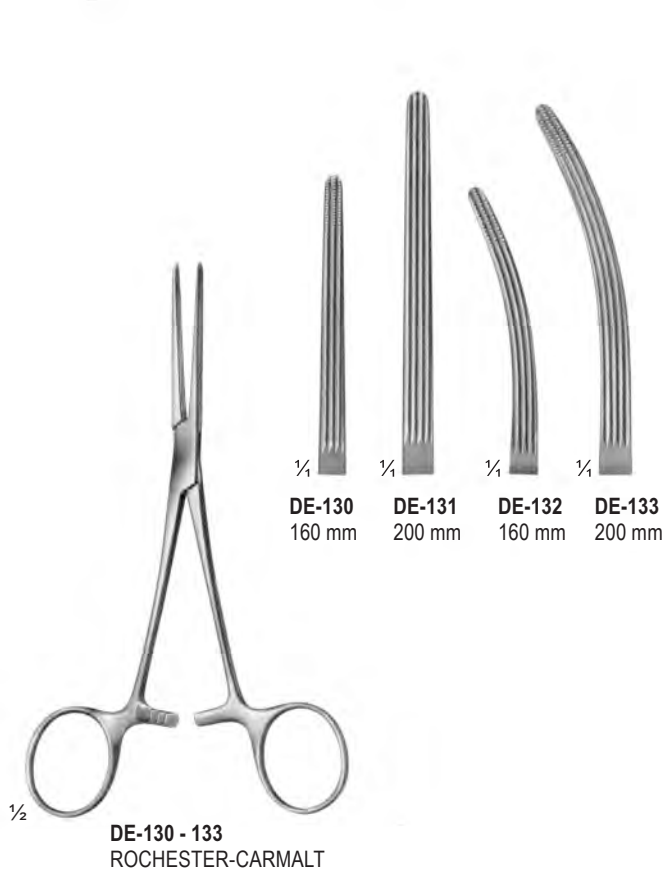



DISSECTING- AND LIGATURE FORCEPS

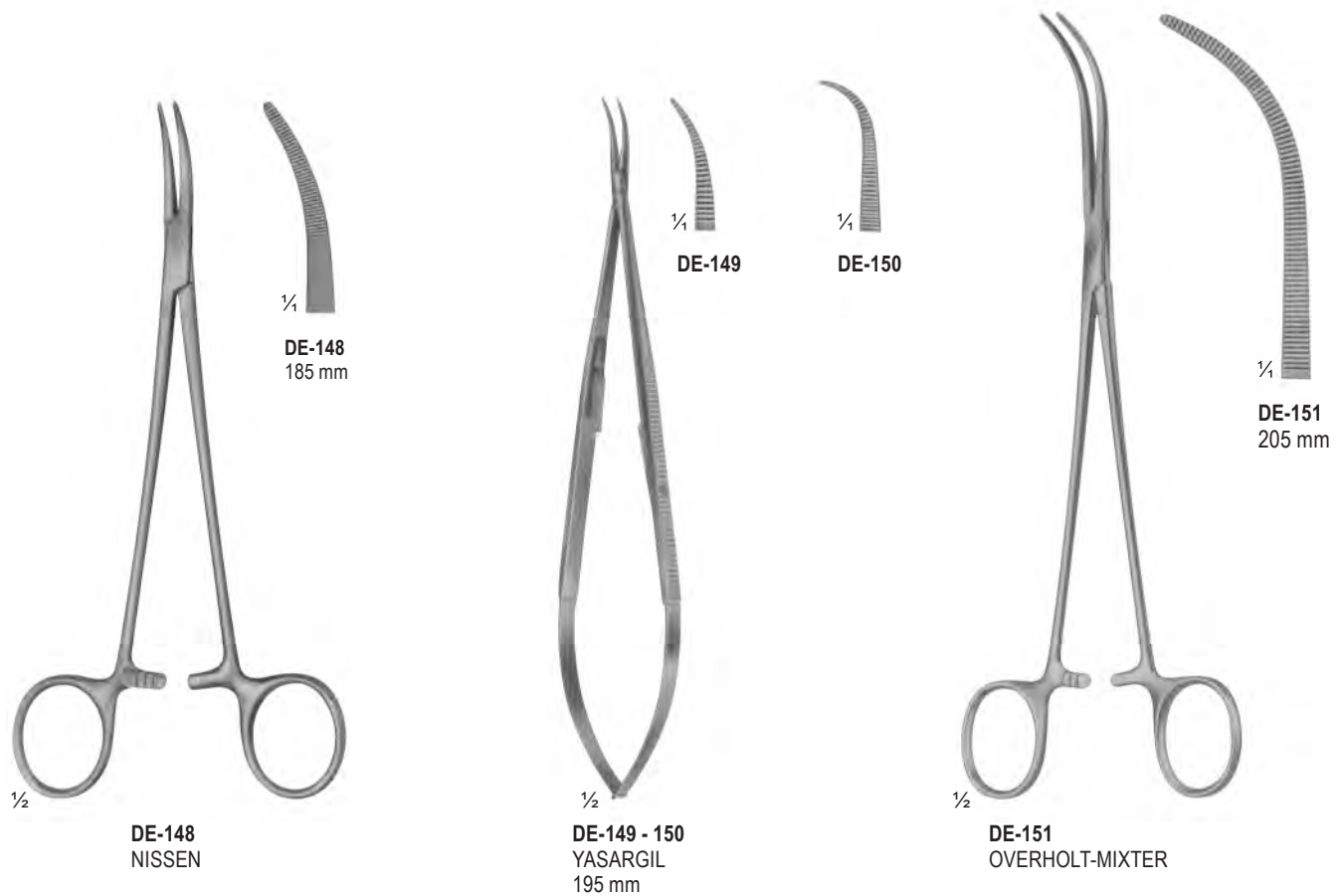
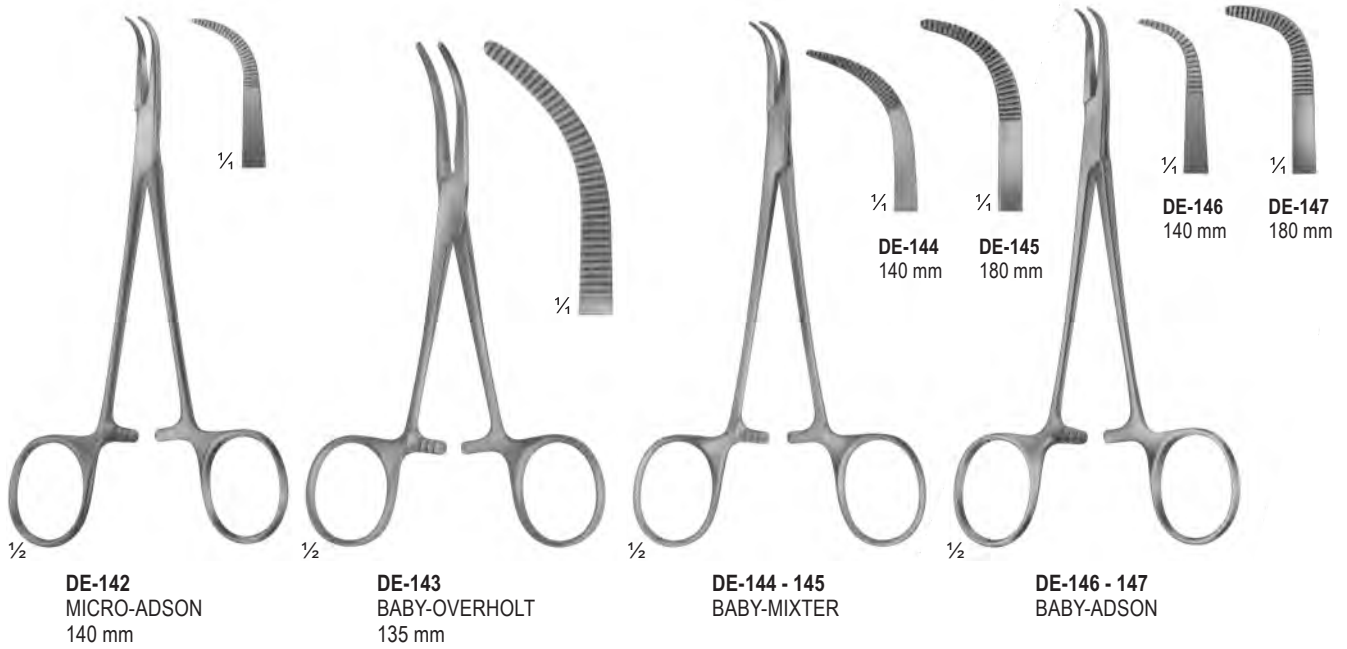

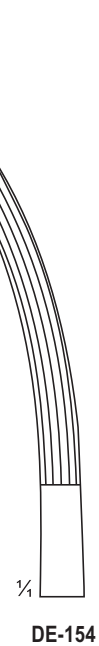
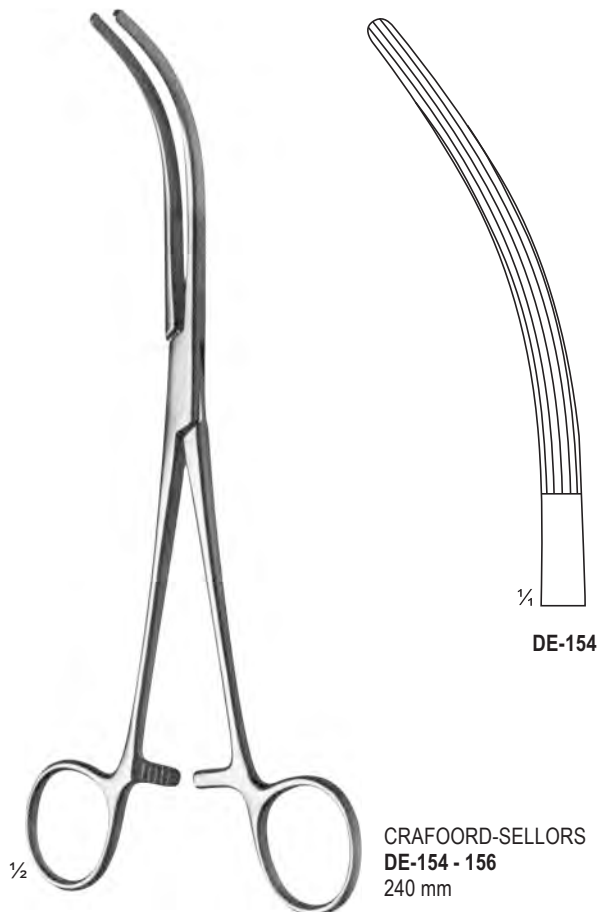
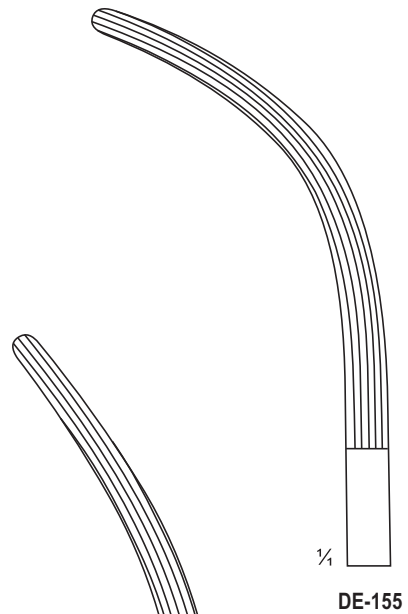
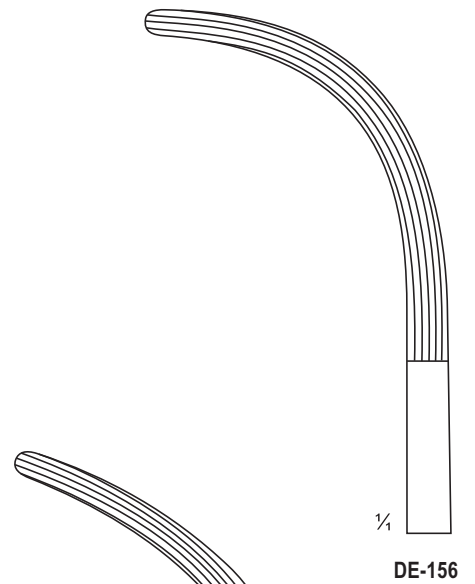
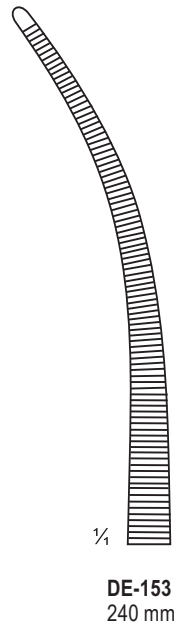
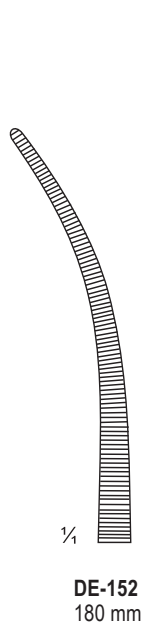



HAEMOSTATIC, SPECIAL PATTERN AND TONSIL FORCEPS

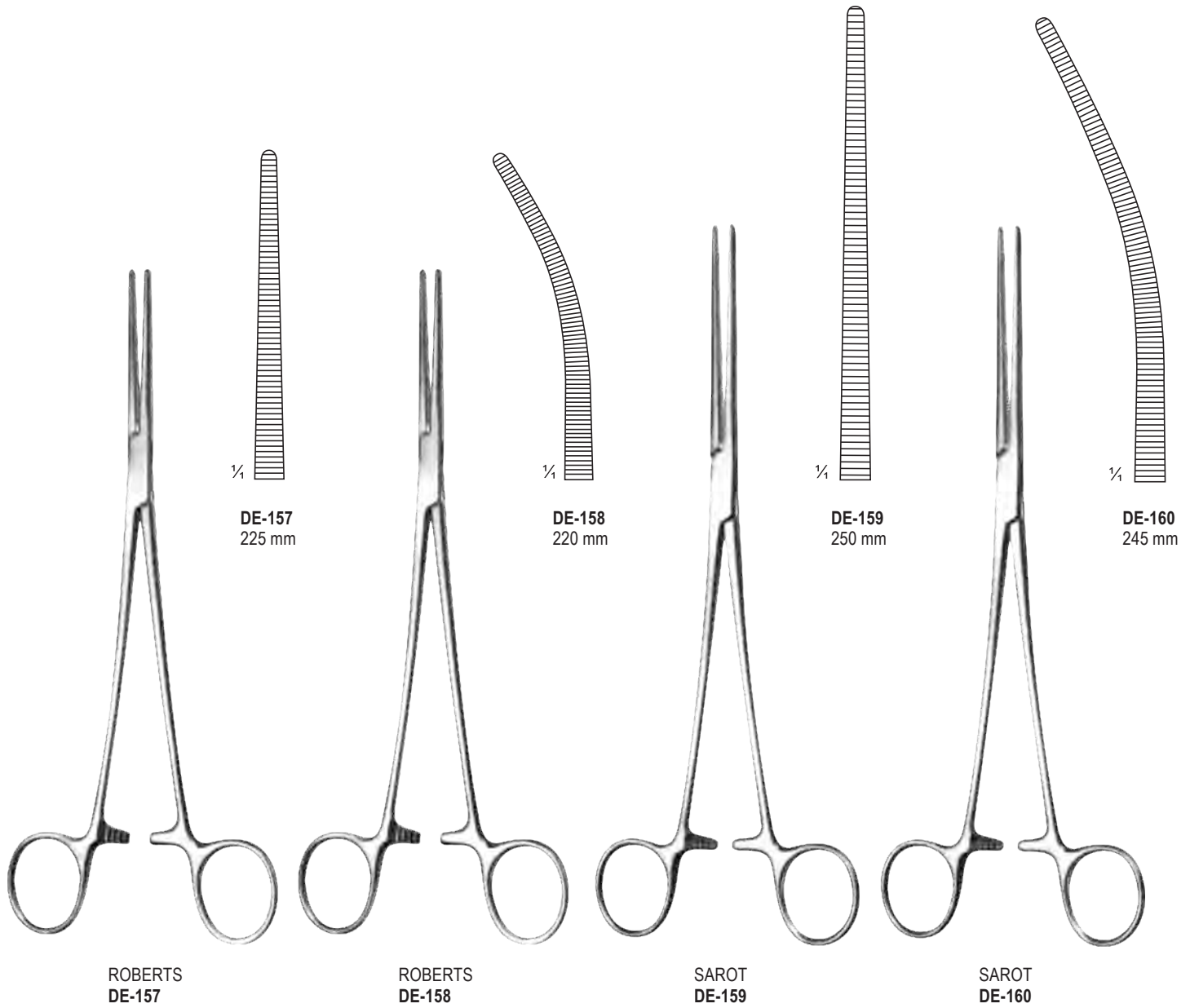



RUMEL
DE-161 - 165
240 mm



DE-161



DE-162



DE-163



DE-164



DE-165

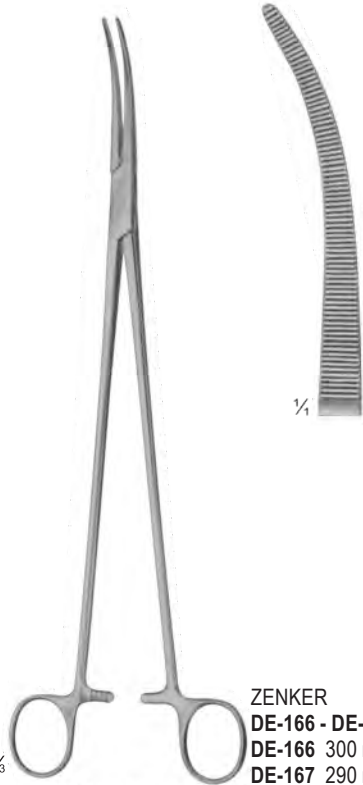

ZENKER
DE-166 - DE-167
DE-166 300 mm
DE-167 290 mm



$\frac{1}{4}$



$\frac{1}{4}$

LAWRENCE
DE-168
270 mm



NEGUS
DE-169 - 170
190 mm



$\frac{1}{4}$

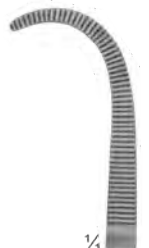

$\frac{1}{4}$

DE-169

DE-170



DISSECTING AND LIGATURE FORCEPS

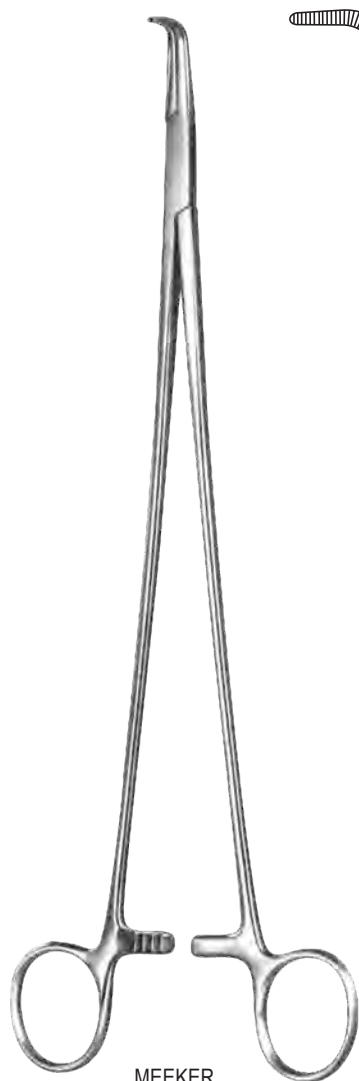

MEEKER
DE-171
280 mm

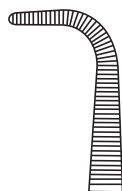

KELLY
DE-172 - 180



Fig. 1
DE-172
190 mm



Fig. 1
DE-173
225 mm



Fig. 1
DE-174
240 mm



Fig. 2
DE-175
190 mm



Fig. 2
DE-176
220 mm



Fig. 2
DE-177
235 mm



Fig. 3
DE-178
185 mm



Fig. 3
DE-179
215 mm



Fig. 3
DE-180
235 mm

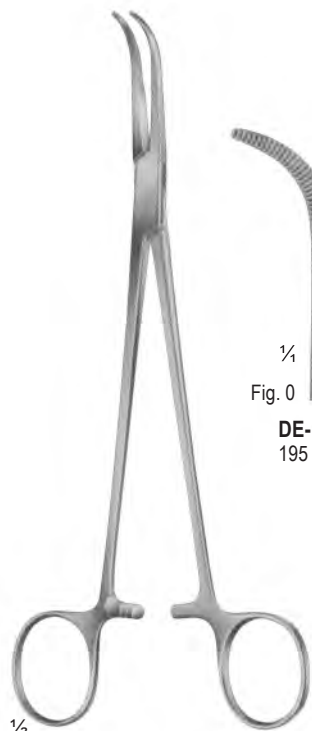

$\frac{1}{2}$
DE-181 - 192
 OVERHOLT-GEISSENDOERFER

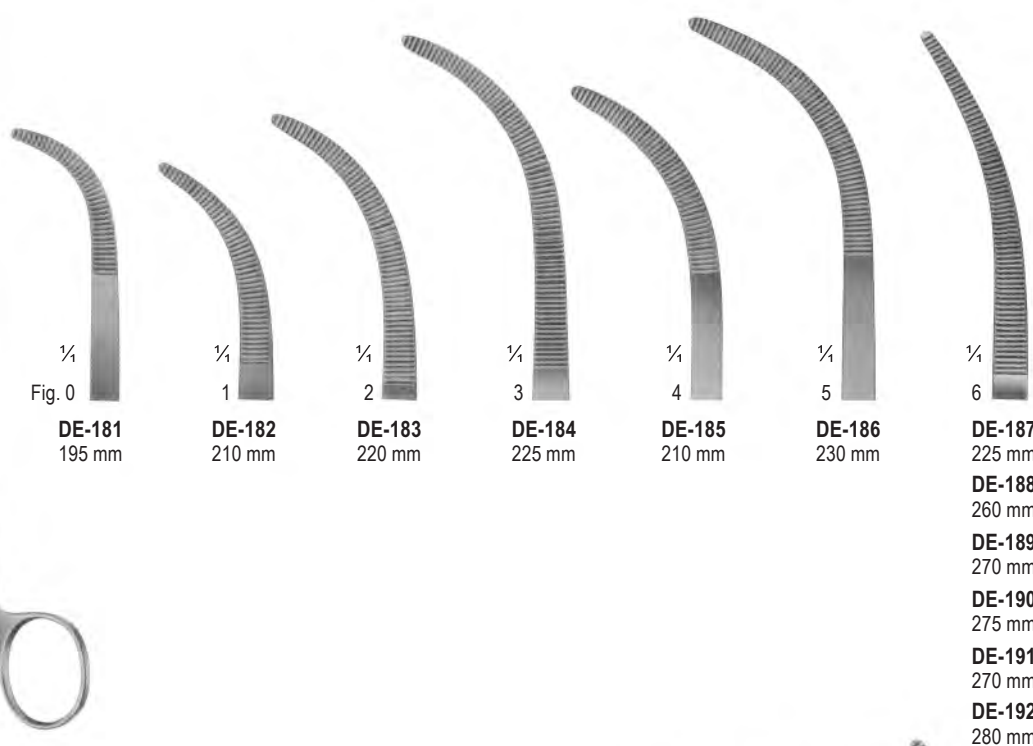

$\frac{1}{4}$ Fig. 0	$\frac{1}{4}$ 1	$\frac{1}{4}$ 2	$\frac{1}{4}$ 3	$\frac{1}{4}$ 4	$\frac{1}{4}$ 5	$\frac{1}{4}$ 6
DE-181 195 mm	DE-182 210 mm	DE-183 220 mm	DE-184 225 mm	DE-185 210 mm	DE-186 230 mm	DE-187 225 mm
						DE-188 260 mm
						DE-189 270 mm
						DE-190 275 mm
						DE-191 270 mm
						DE-192 280 mm

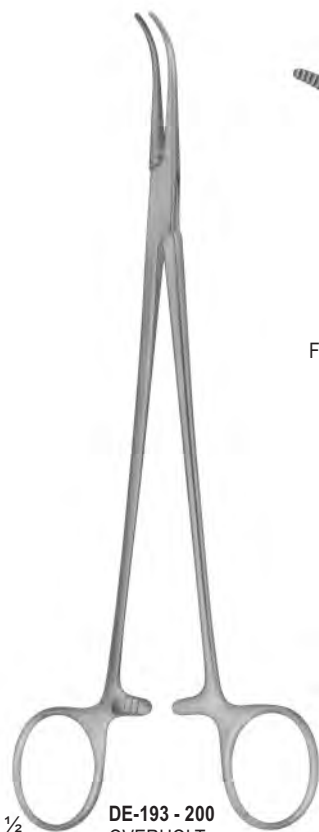

$\frac{1}{2}$
DE-193 - 200
 OVERHOLT
 fine pattern

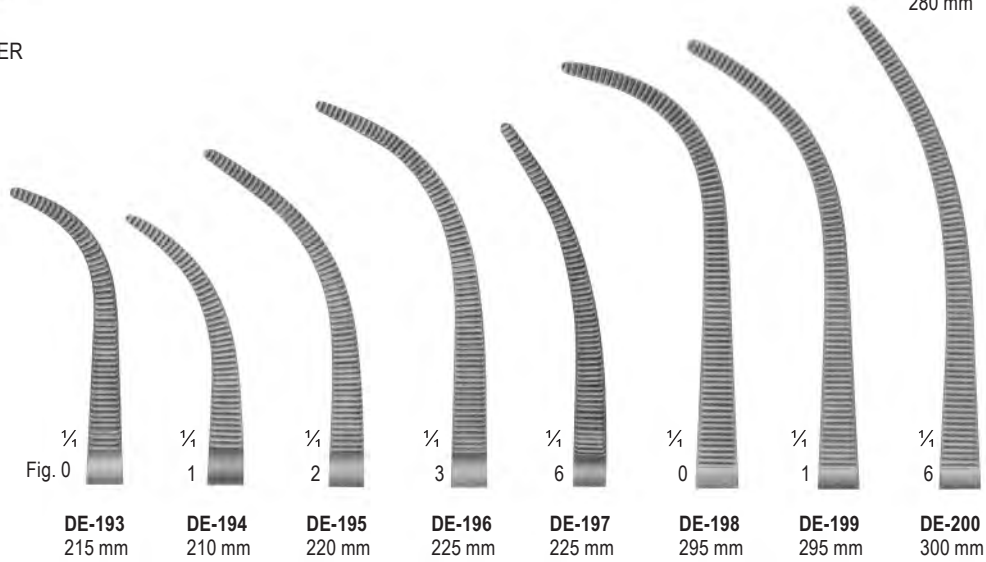

$\frac{1}{4}$ Fig. 0	$\frac{1}{4}$ 1	$\frac{1}{4}$ 2	$\frac{1}{4}$ 3	$\frac{1}{4}$ 6	$\frac{1}{4}$ 0	$\frac{1}{4}$ 1	$\frac{1}{4}$ 6
DE-193 215 mm	DE-194 210 mm	DE-195 220 mm	DE-196 225 mm	DE-197 225 mm	DE-198 295 mm	DE-199 295 mm	DE-200 300 mm



HAEMOSTATIC FORCEPS



MINI-GEMINI
DE-201 - 204

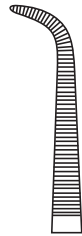

DE-201
180 mm

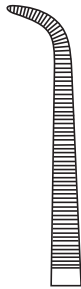

DE-202
230 mm

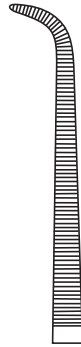

DE-203
250 mm



DE-204
280 mm



OVERHOLT-MINI
DE-205
200 mm



GEMINI
DE-206 - DE-212



DE-206
130 mm



DE-207
160 mm



DE-208
180 mm



DE-209
210 mm



DE-210
230 mm



DE-211
250 mm

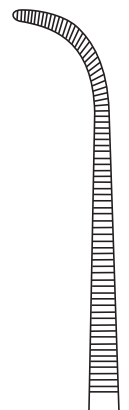

DE-212
280 mm

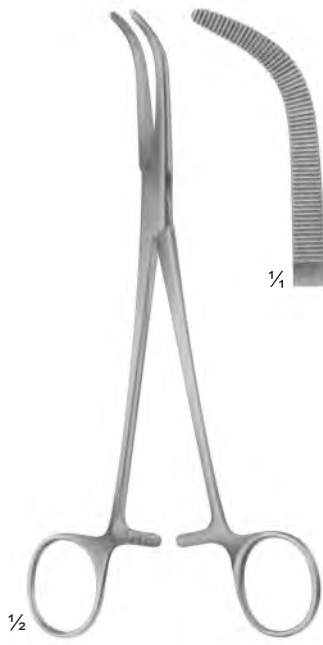

DE-213
MIXTER-O'SHAUGNESSY
190 mm

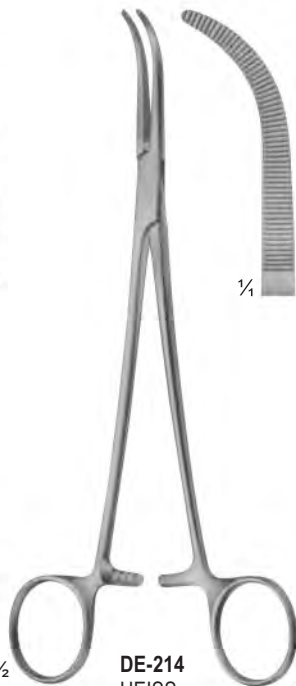

DE-214
HEISS
195 mm

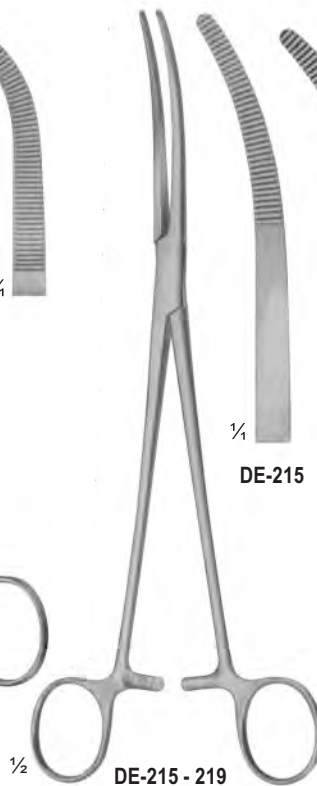

DE-215 - 219
RUMEL
240 mm

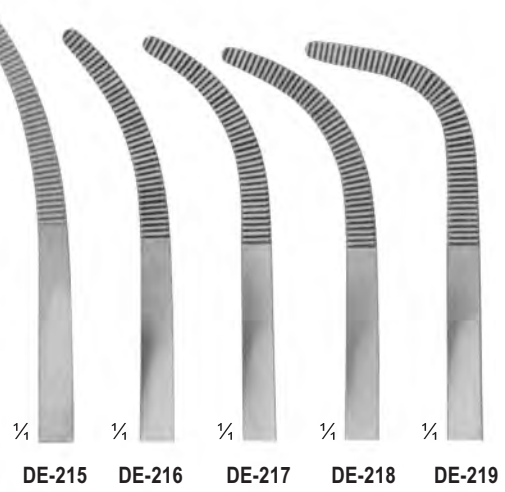

DE-215 **DE-216** **DE-217** **DE-218** **DE-219**

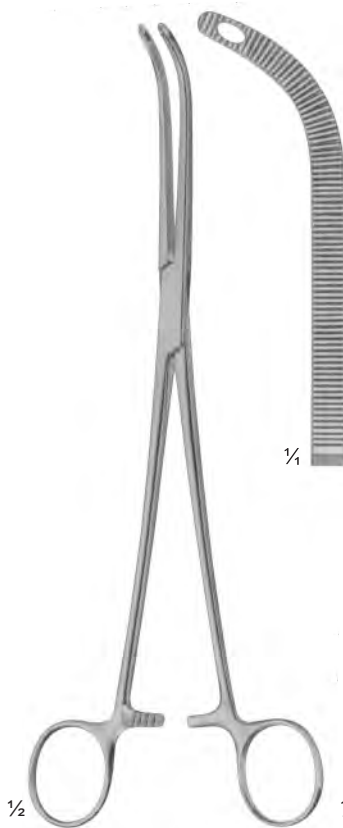

DE-220
FINOCHIETTO
245 mm

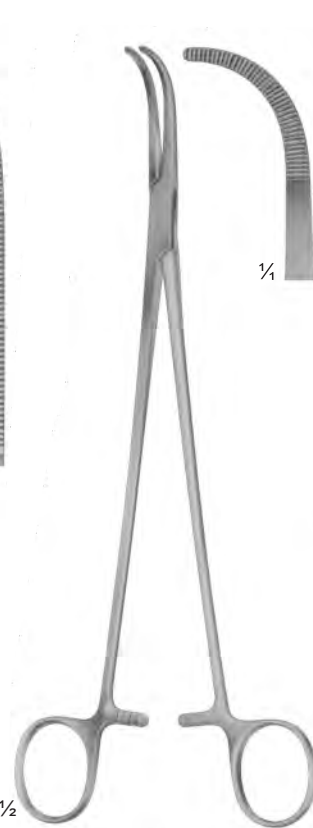

DE-221
MIXTER
230 mm



DE-222
LAWRENCE
270 mm

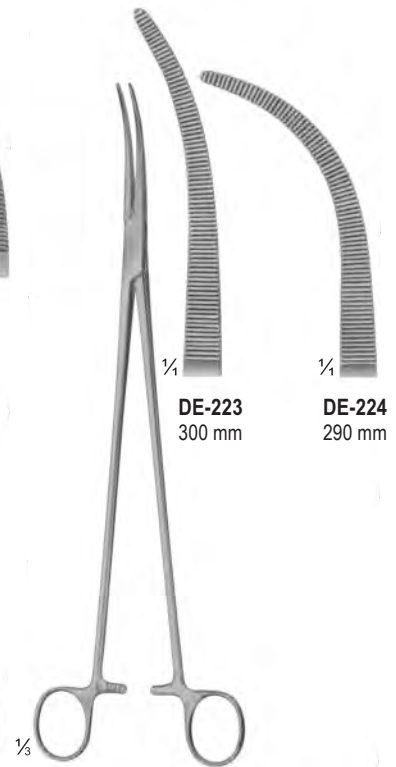

DE-223 **DE-224**
300 mm 290 mm



DISSECTING AND LIGATURE FORCEPS

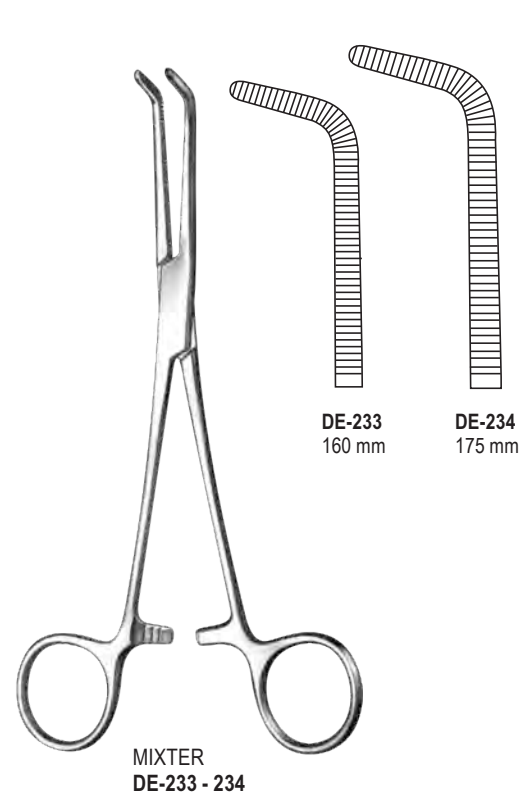
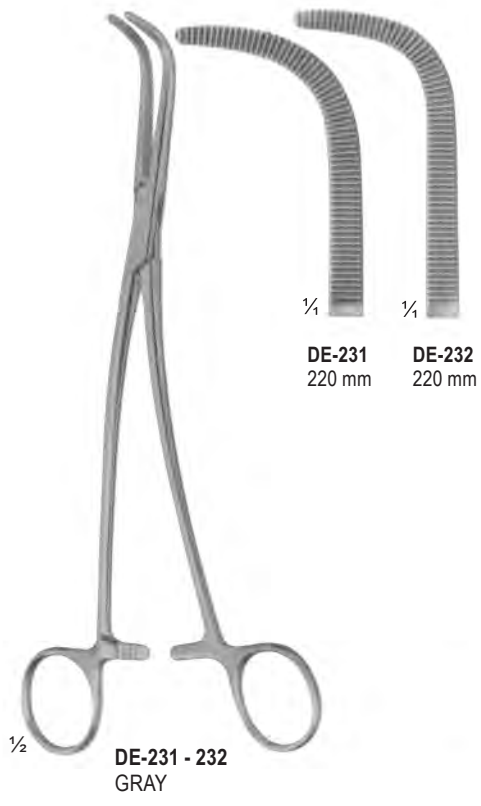
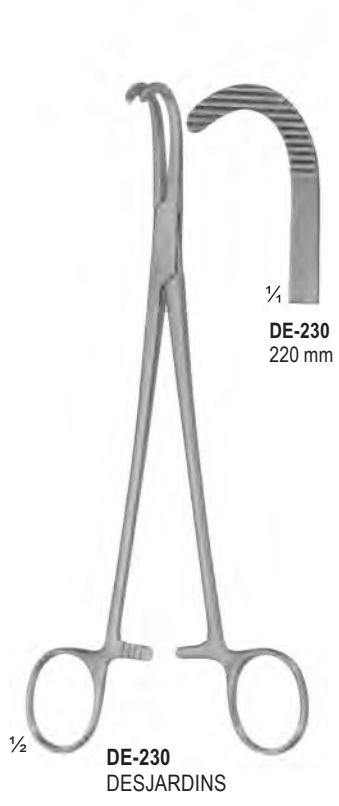
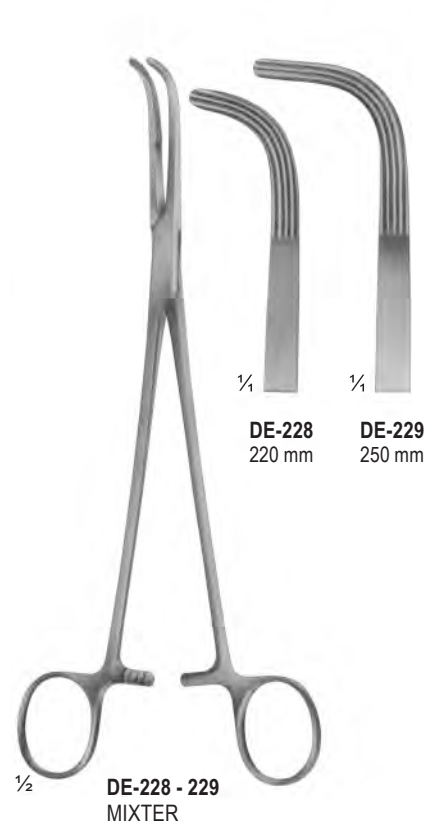

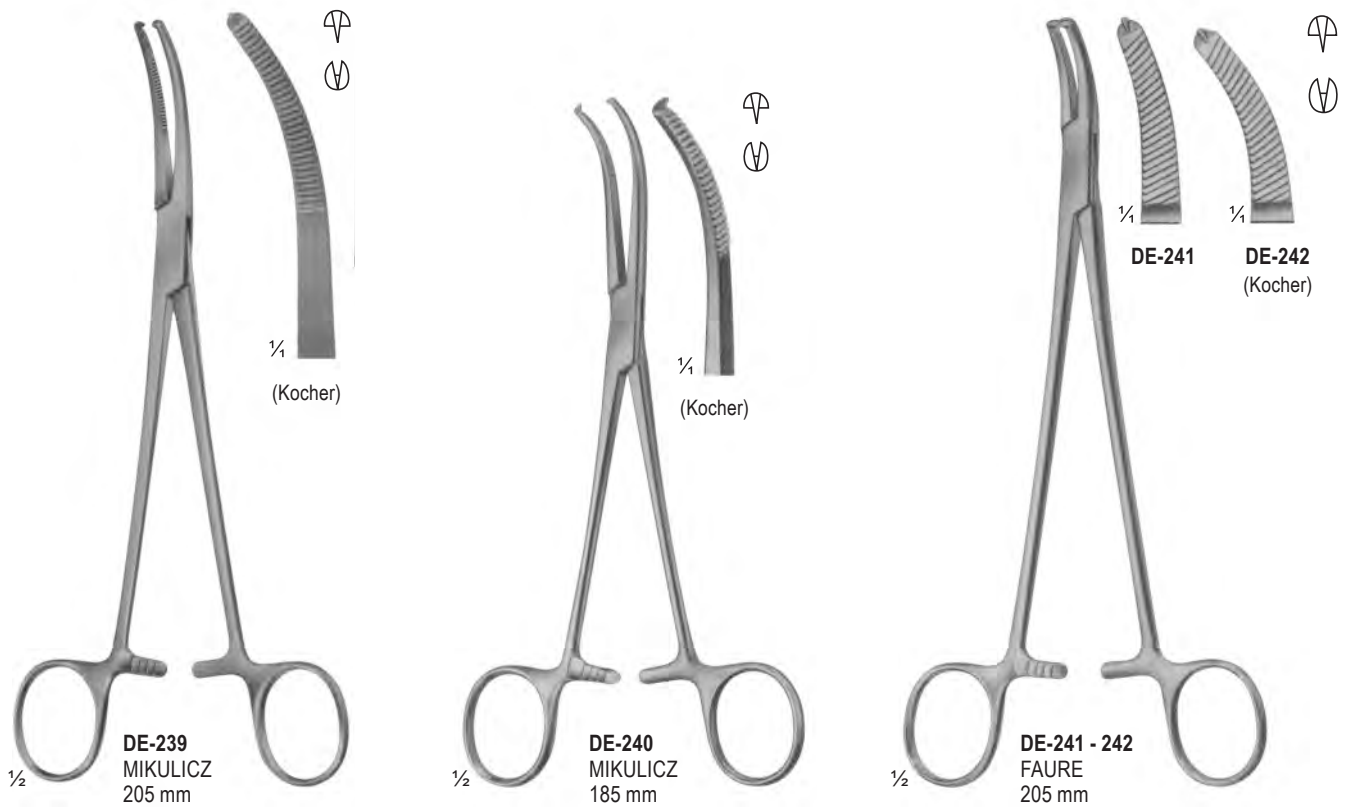
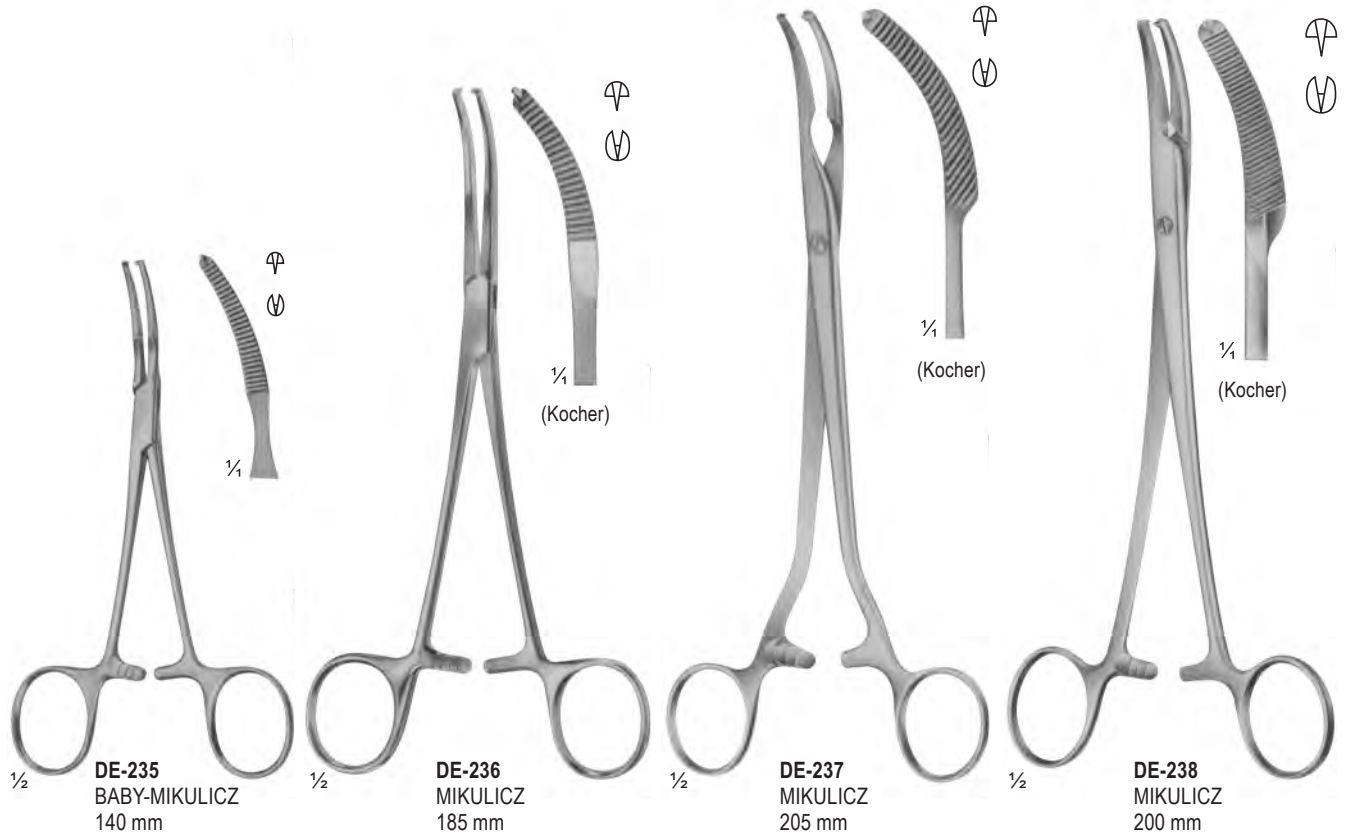

HYSTERECTOMY FORCEPS

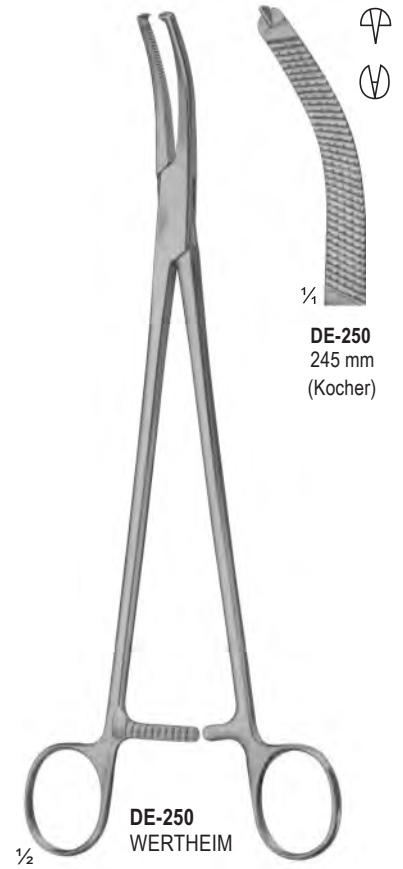
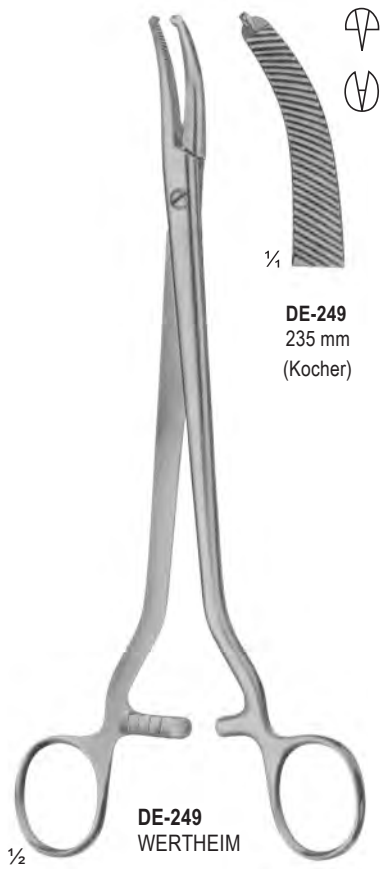
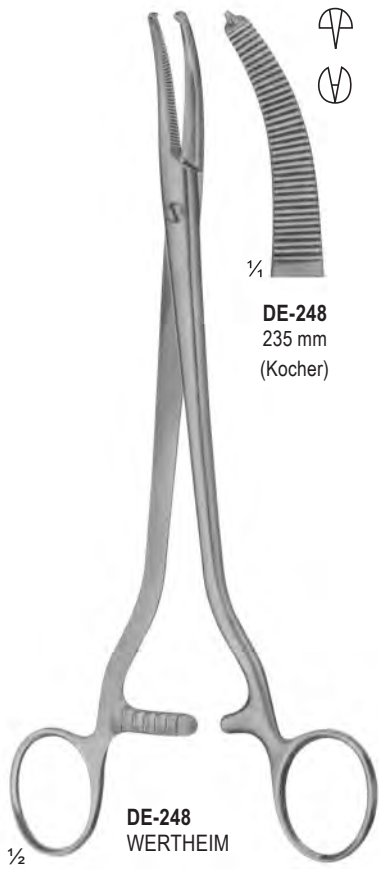
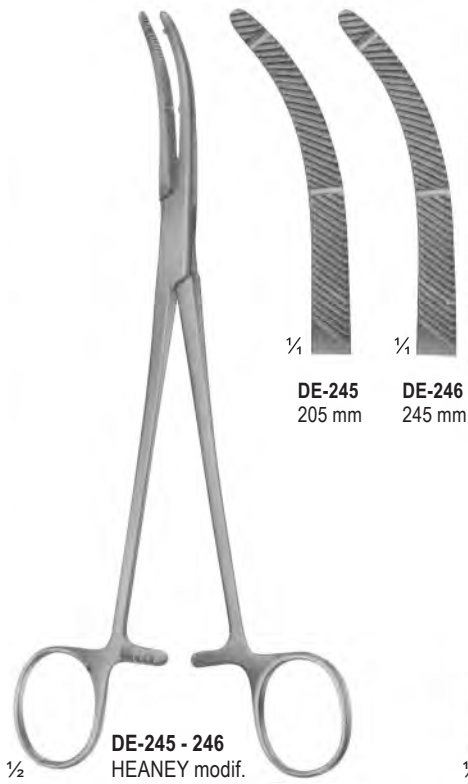



DE-251
225 mm



DE-252
220 mm



DE-253
215 mm



DE-254
205 mm



DE-255
250 mm



DE-256
245 mm



DE-257
240 mm

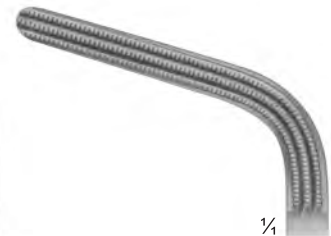

DE-258
220 mm



HYSTERECTOMY FORCEPS,
VAGINAL CLAMPS AND COMPRESSION FORCEPS

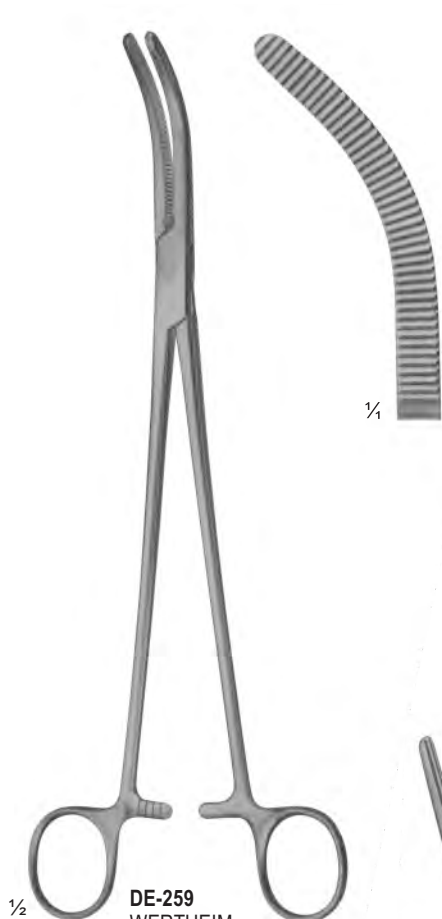

$\frac{1}{2}$ **DE-259**
WERTHEIM
Hysterectomy Forceps
255 mm

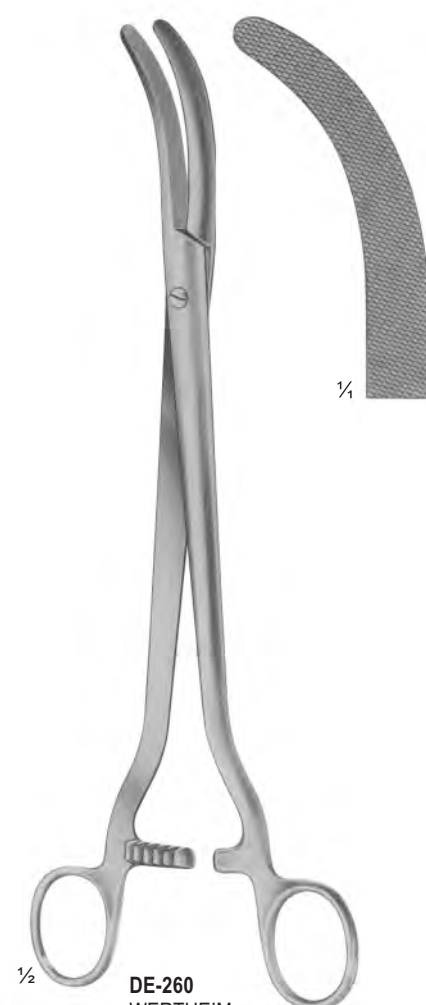

$\frac{1}{2}$ **DE-260**
WERTHEIM
Parametrium Clamp
260 mm

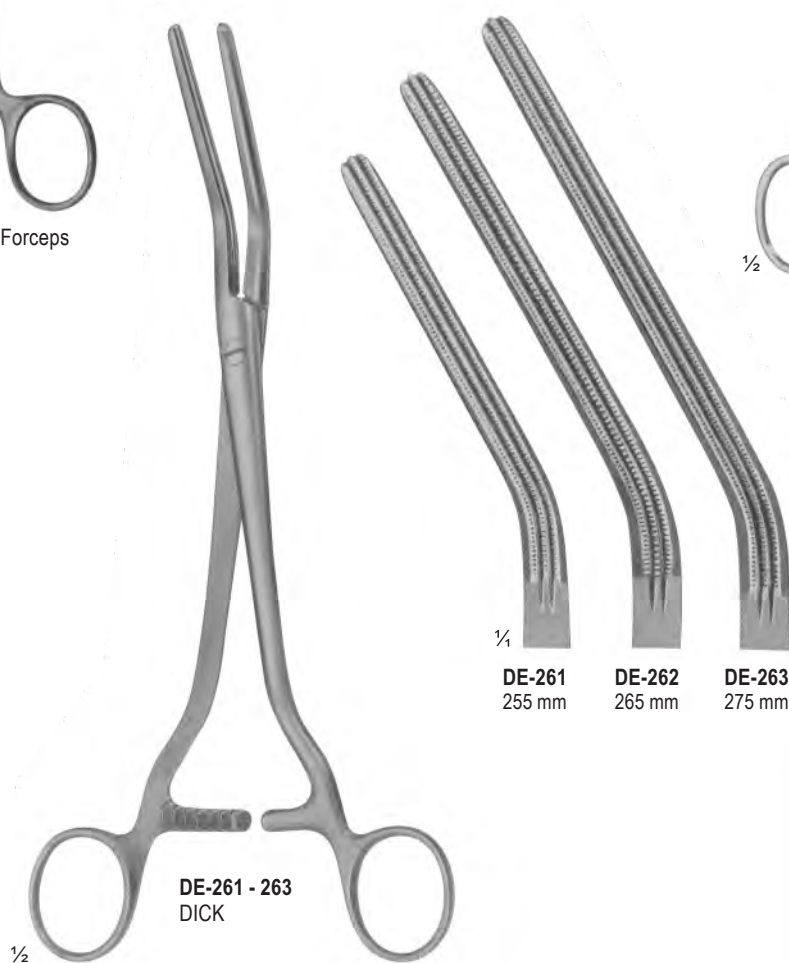

$\frac{1}{2}$ **DE-261 - 263**
DICK

$\frac{1}{4}$ **DE-261** 255 mm
DE-262 265 mm
DE-263 275 mm

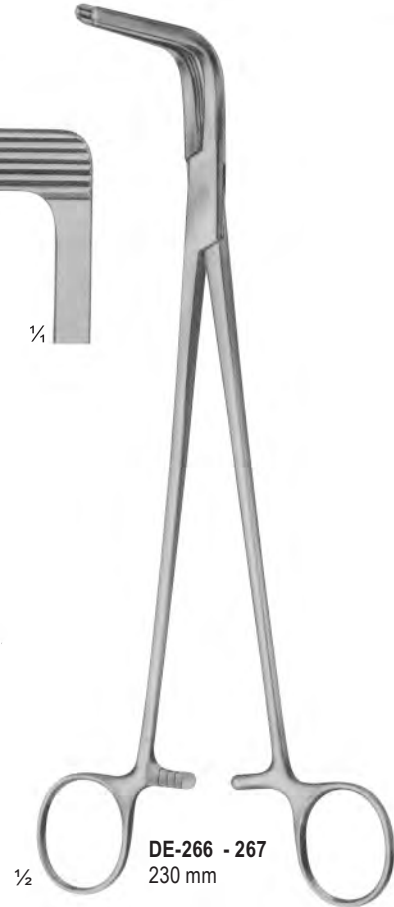

DELICATE HAEMOSTATIC FORCEPS

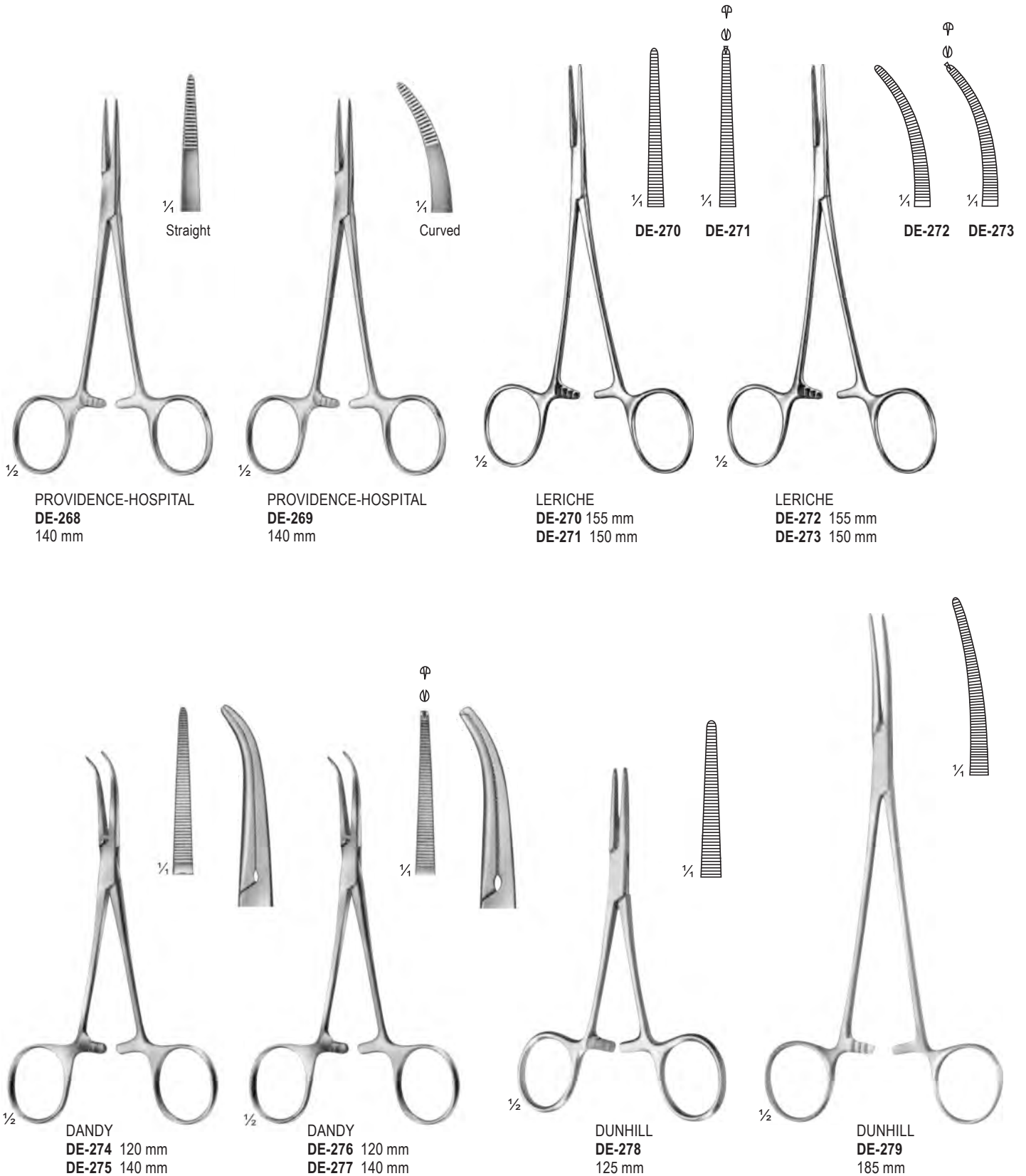

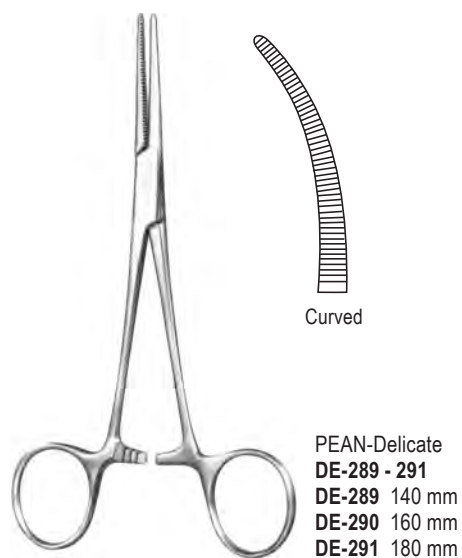
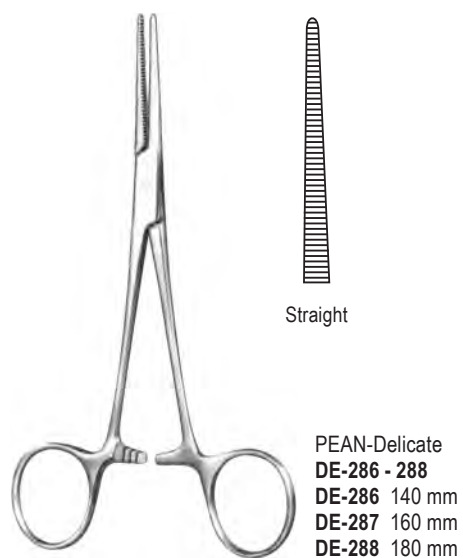
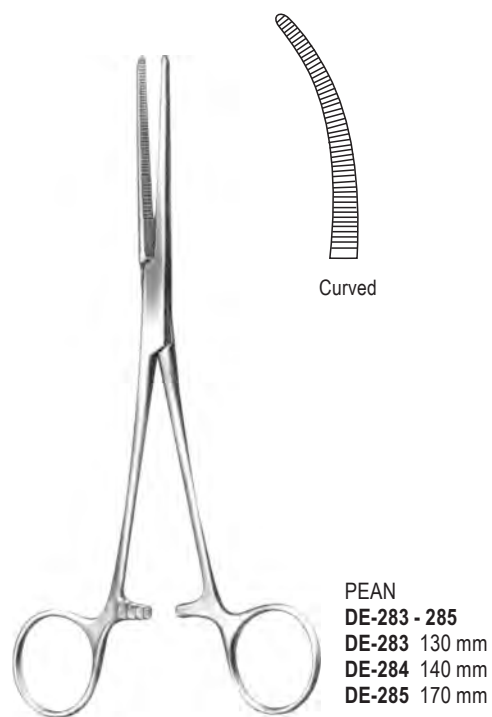
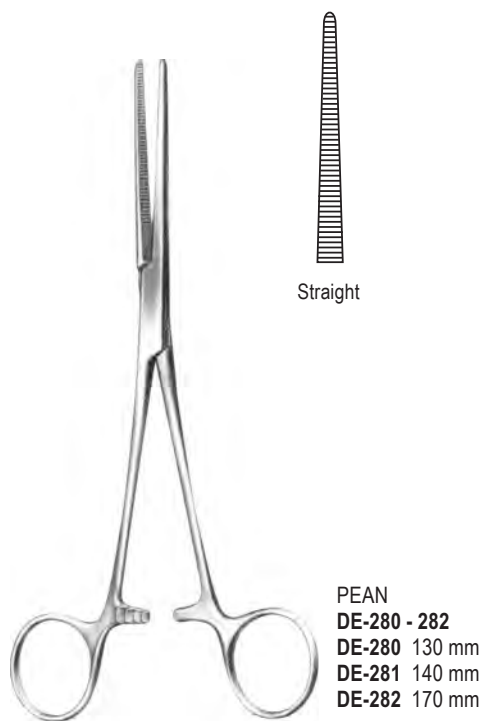



DISSECTING AND LIGATURE FORCEPS



FINOCHIETTO
DE-292
245 mm

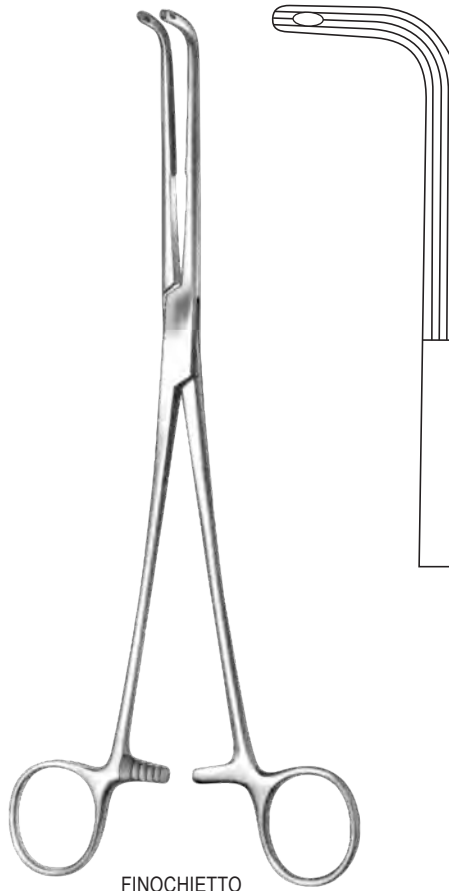

FINOCHIETTO
DE-293
245 mm



LAHEY (SWEET)
DE-294 190 mm
DE-295 230 mm

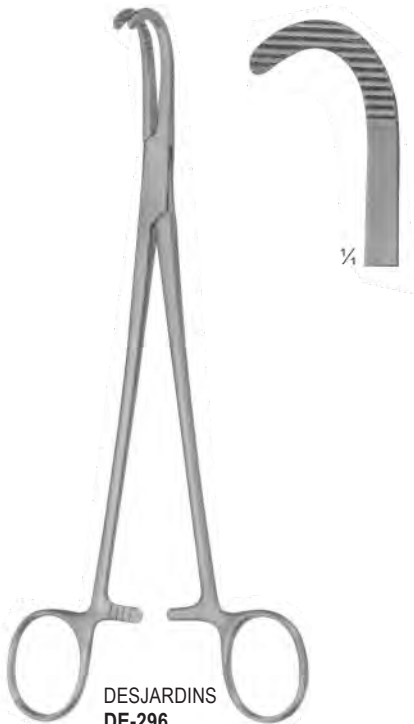

DESJARDINS
DE-296
210 mm



LOWER
DE-297
180 mm



NISSEN
DE-298
180 mm



GRAY
DE-299 - 300
220 mm



DE-299

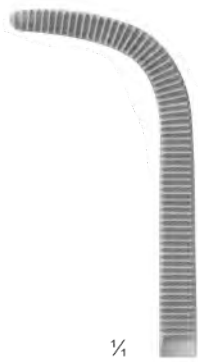

DE-300



GRAY
DE-301 - 302
220 mm



DE-301

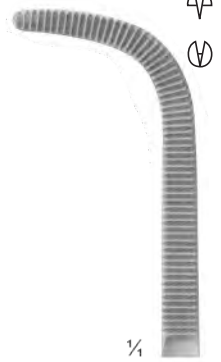

DE-302



NEGUS
DE-303 - 304
190 mm



DE-303



DE-304



MOYNIHAN
DE-305 - 306



DE-305
230 mm

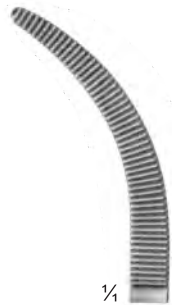

DE-306
240 mm



TUBING CLAMPS

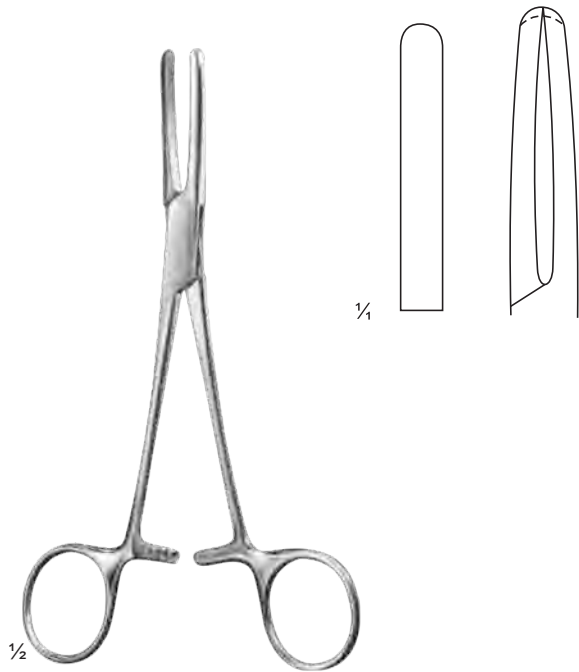

DE-307
16.5 cm

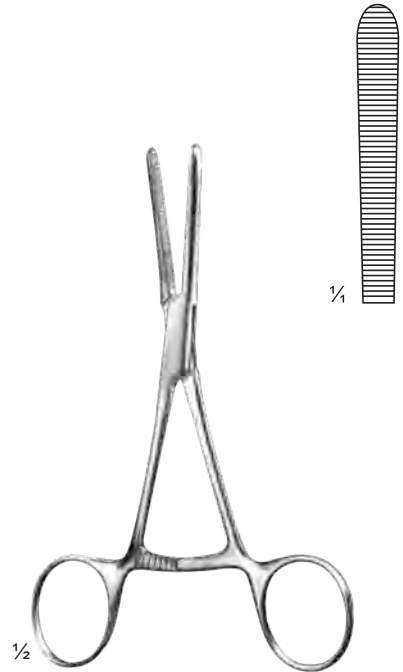

DE-308
14 cm

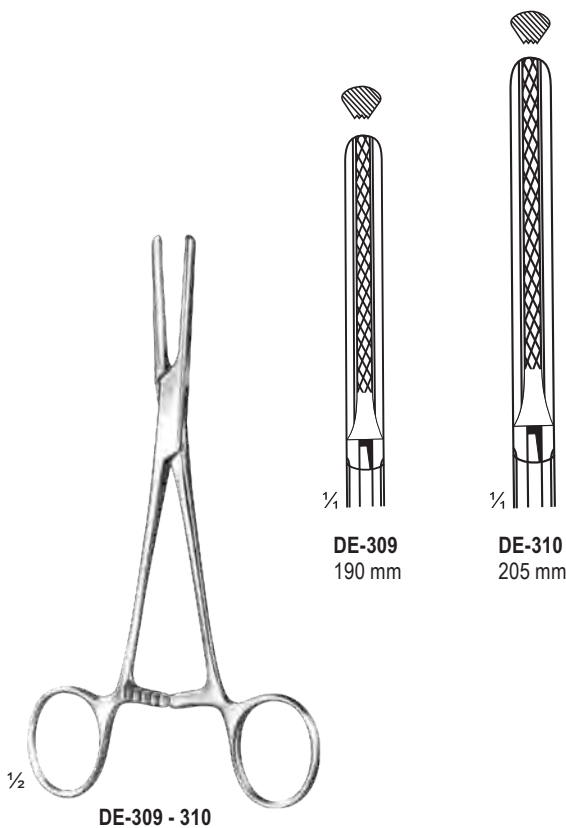

DE-309 - 310

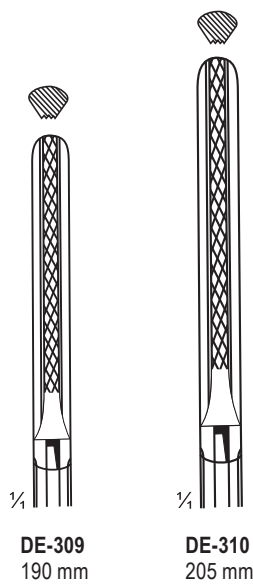

DE-309
190 mm

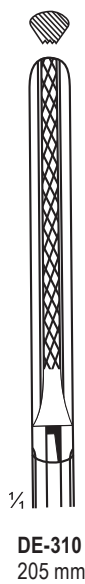

DE-310
205 mm

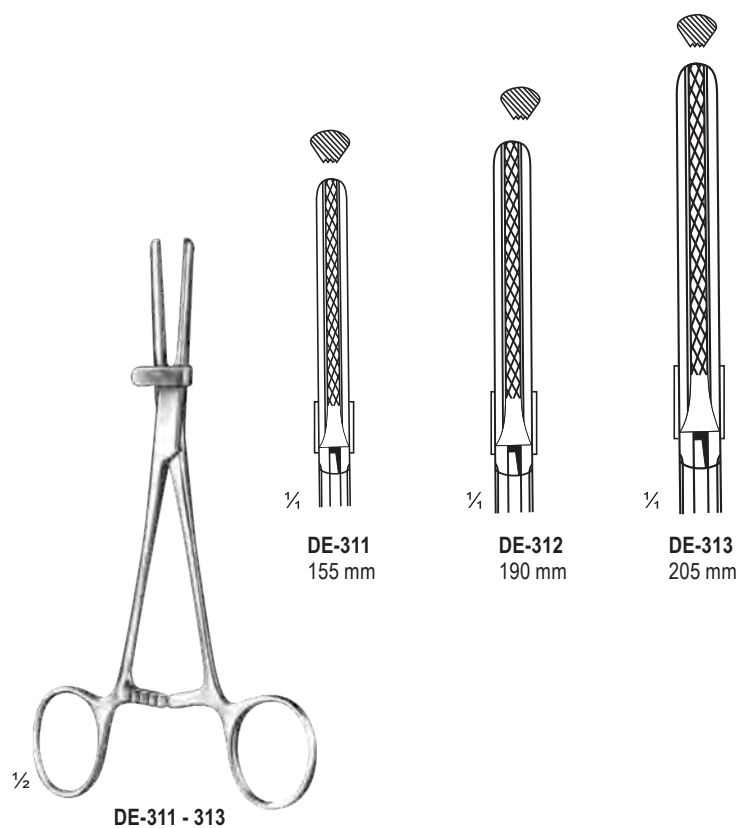

DE-311 - 313

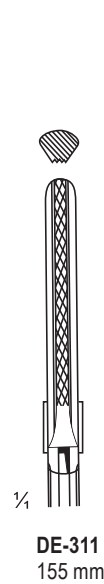

DE-311
155 mm

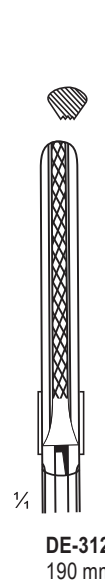

DE-312
190 mm

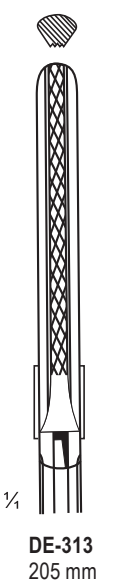

DE-313
205 mm



Fig. 1
DE-314
195 mm

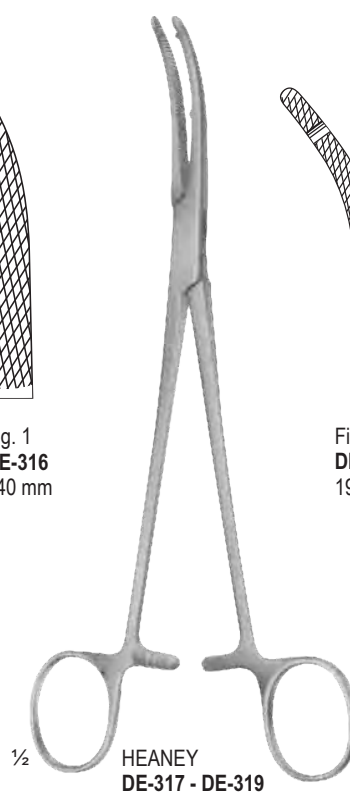
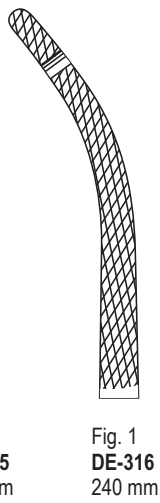
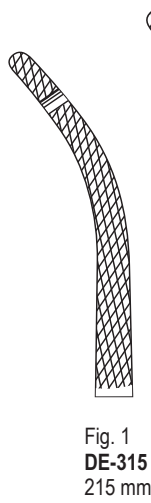

Fig. 2
DE-317
195 mm

