

Page 01-27

- Elevators
- Bone Levers
- Raspatories
- Bone Curettes
- Bone Rasps

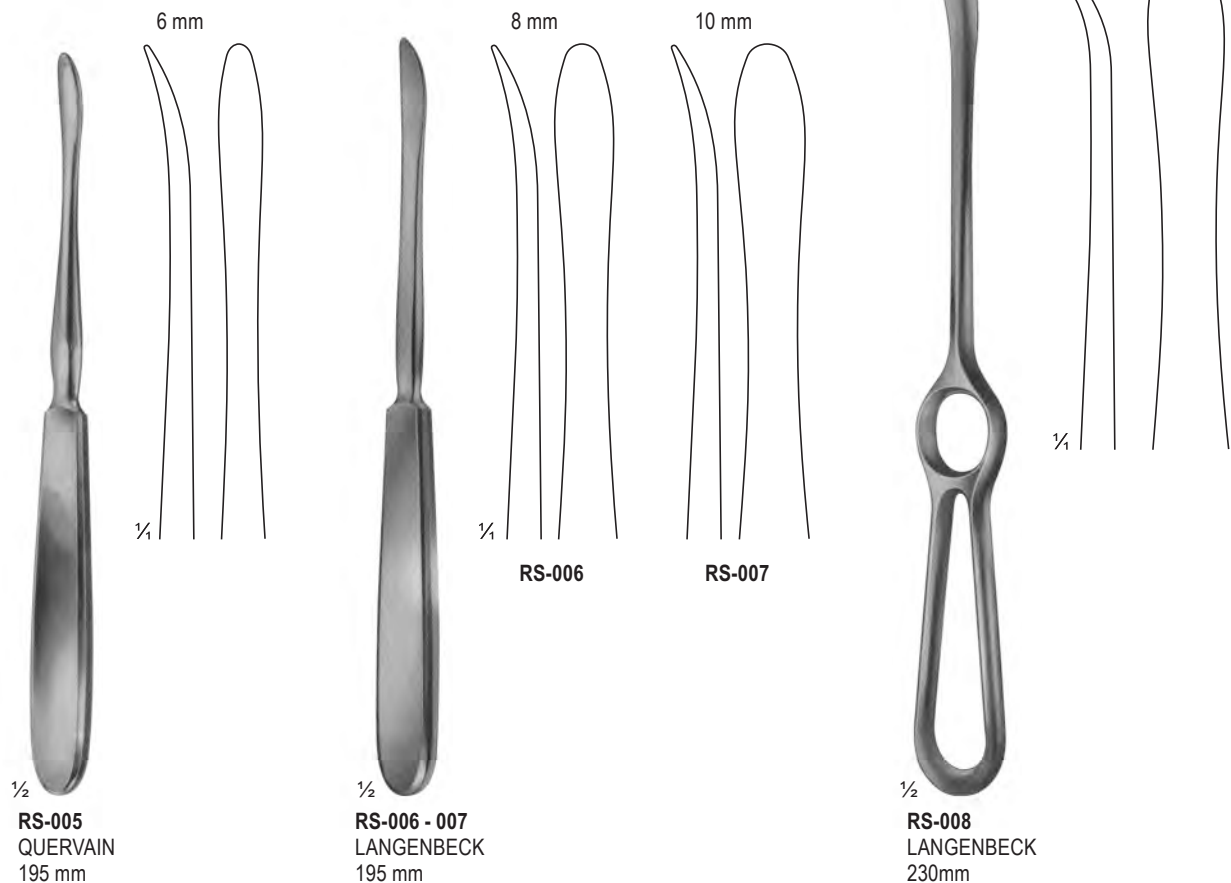

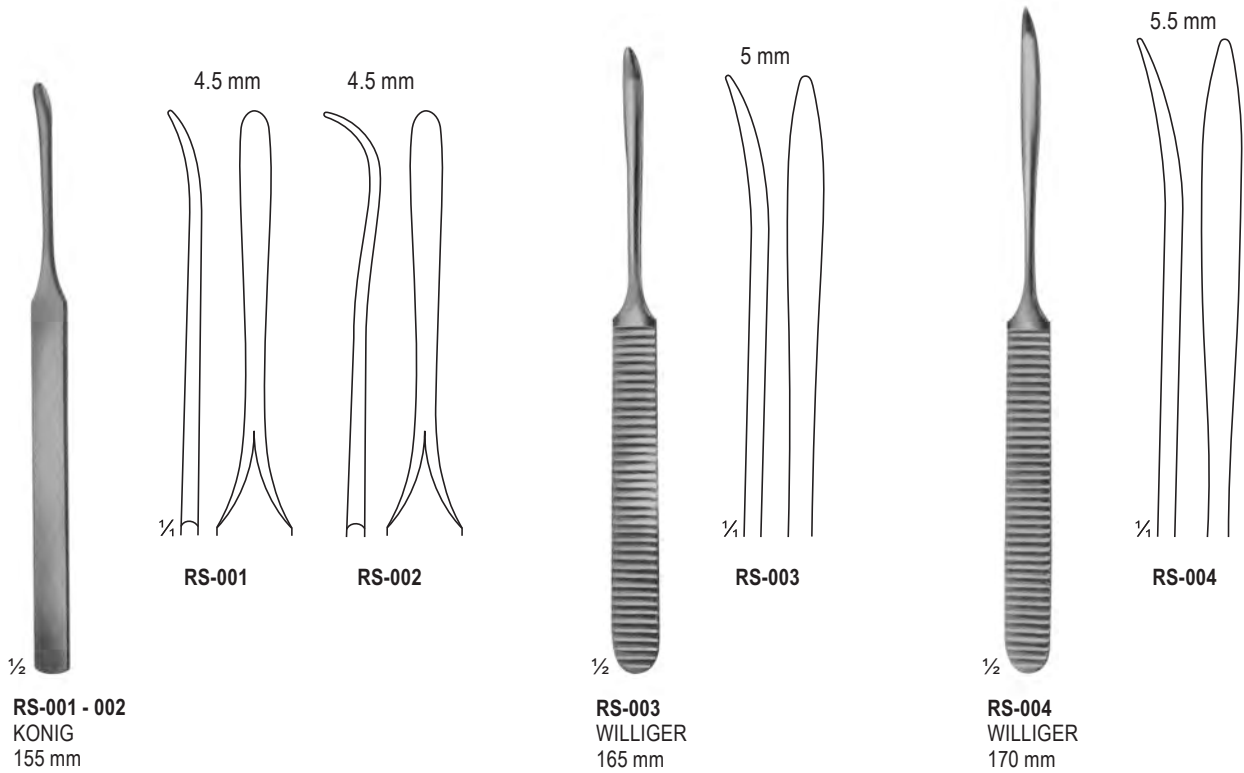

BONE LEVERS

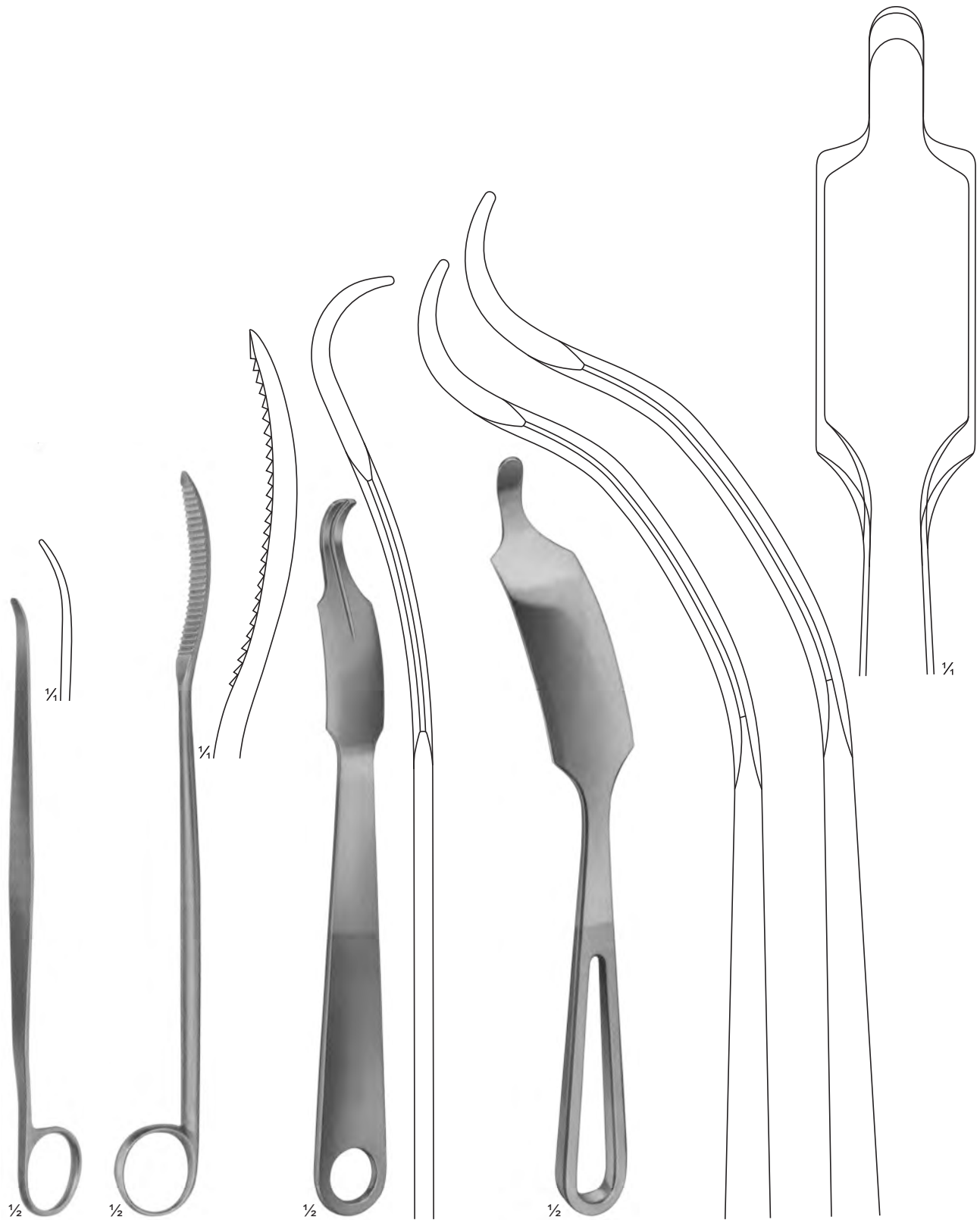

RS-009
LANE
TRETOWAN
215mm

RS-010
LANE
255mm

RS-011
LANGE-HOHMANN
250mm

RS-012 - 013
LANGE-HOHMANN
RS-012 265mm
RS-013 280mm

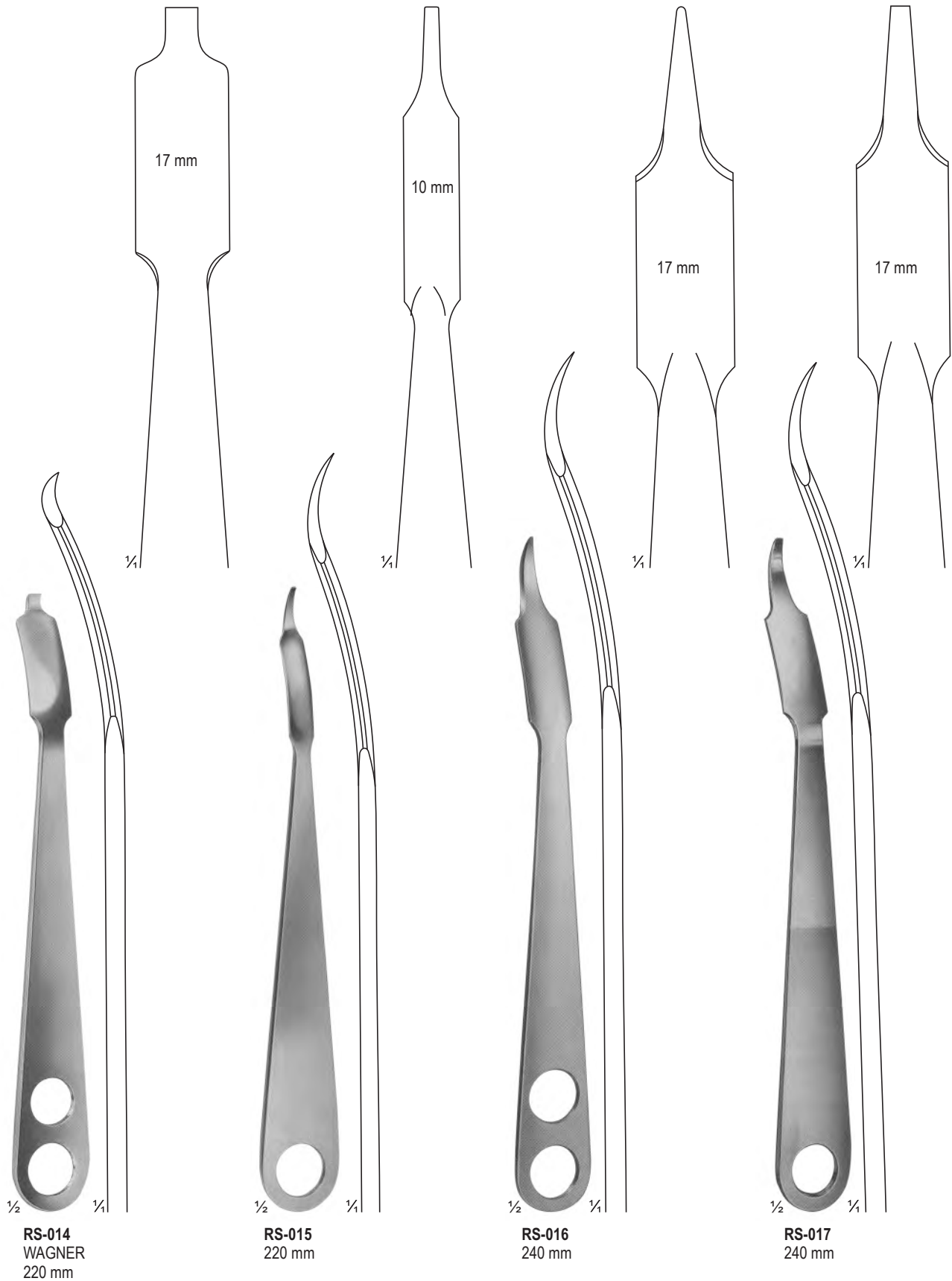



BONE LEVERS

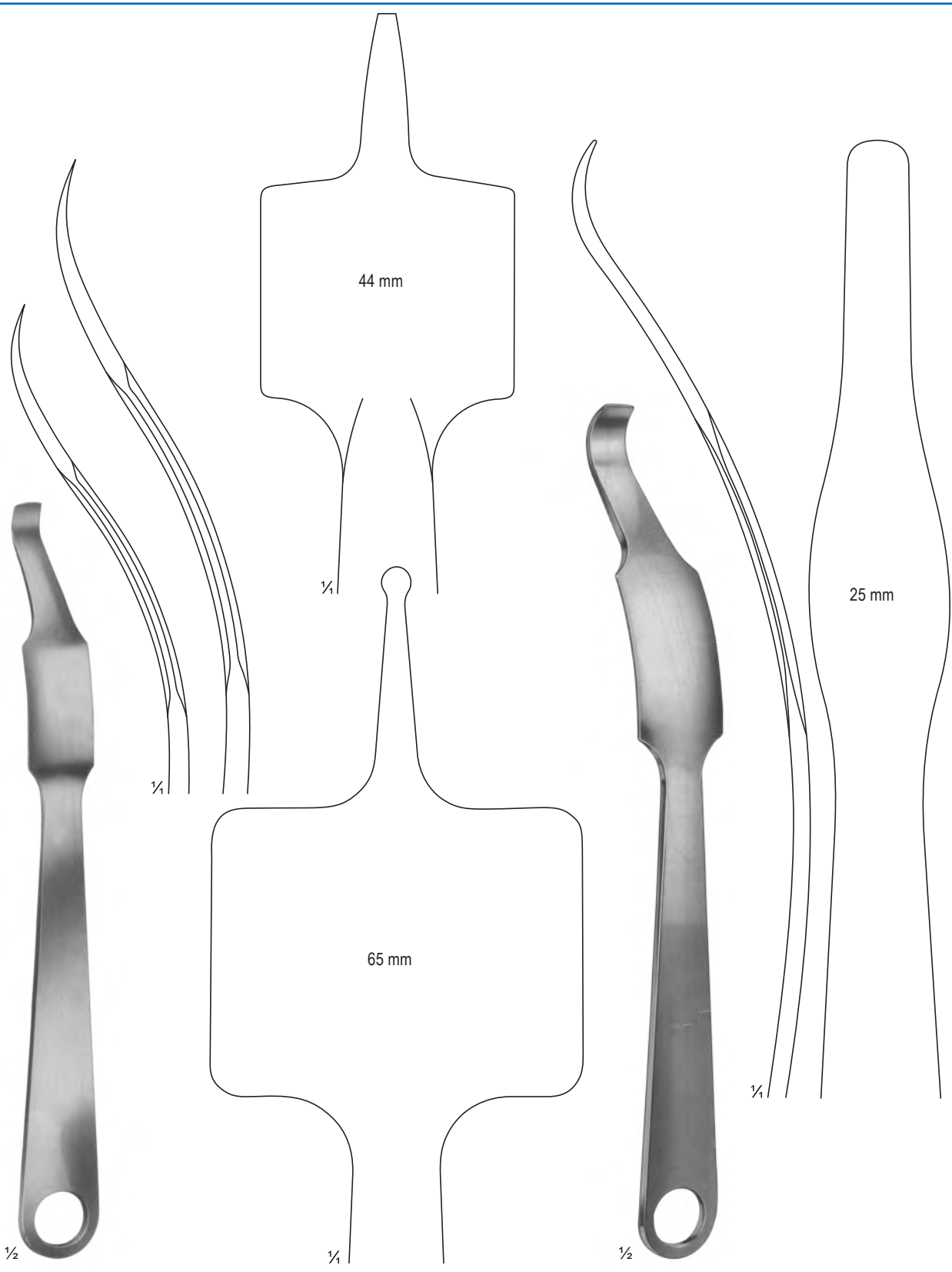

RS-018 - 019
VERBRUGGE-MULLER
RS-018 240 mm
RS-019 255 mm

RS-020
 260 mm

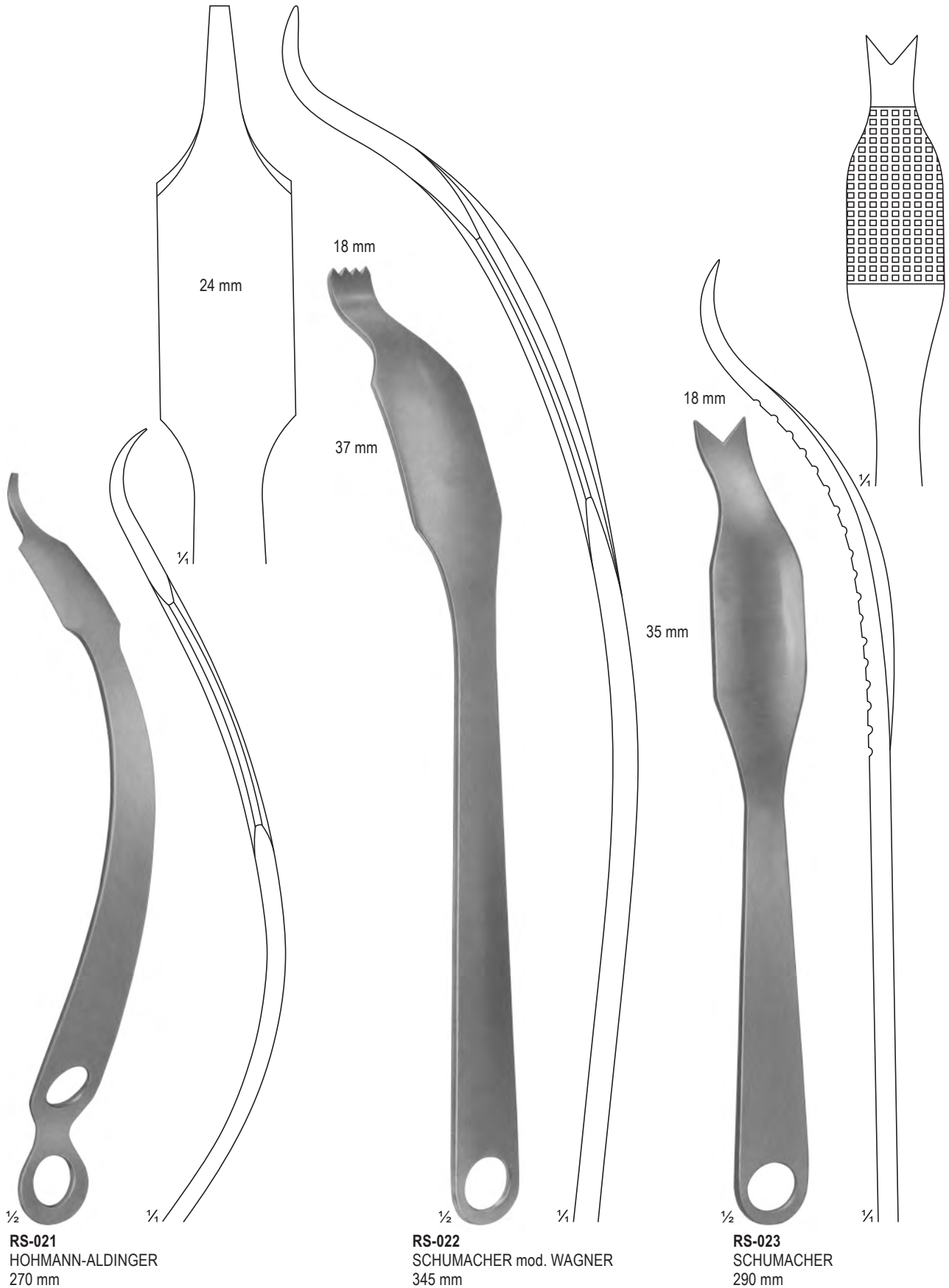



BONE LEVERS

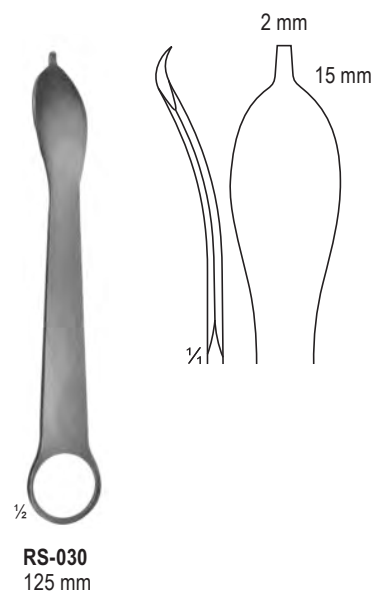
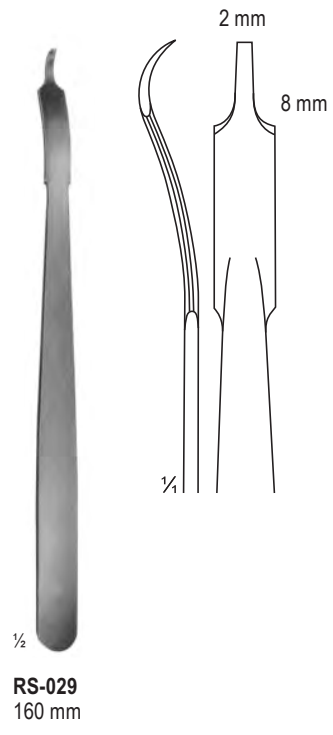
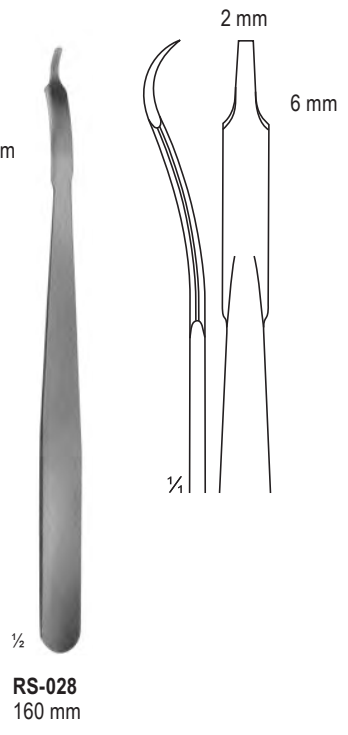
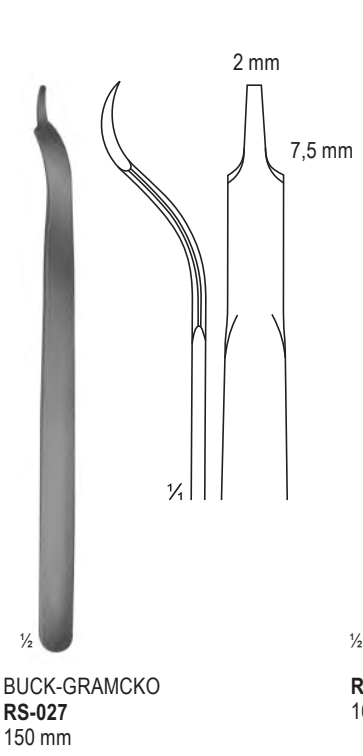
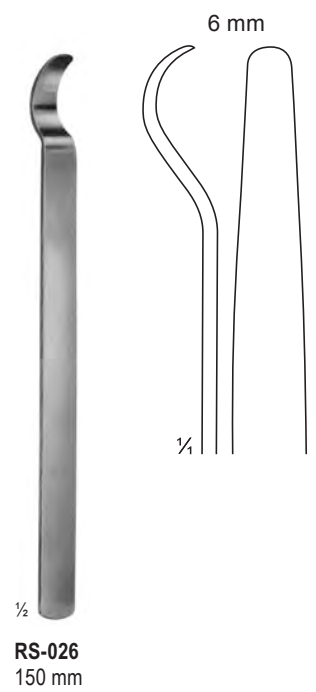
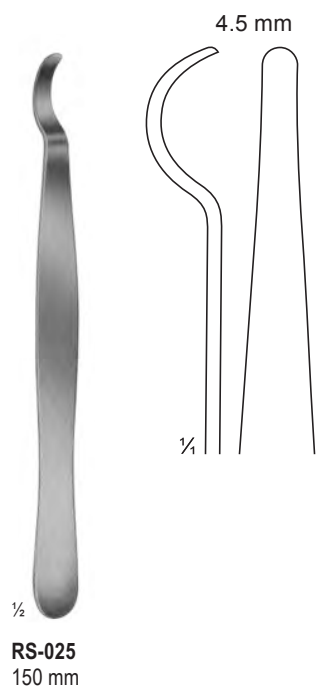
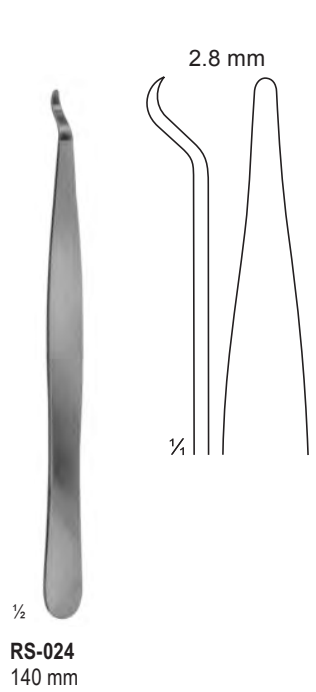



RS-031 - 032
 PARTSCH
 150 mm

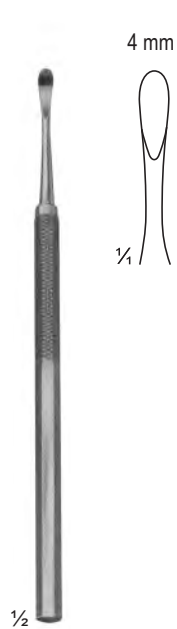

RS-033
 PARTSCH mod. LANGE
 145 mm

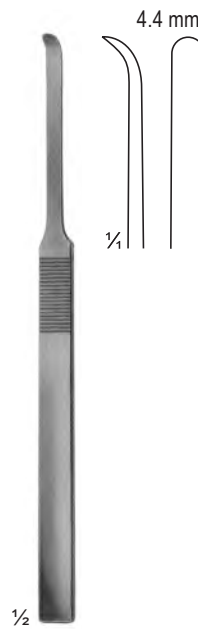

RS-034
 MC KENTY
 155 mm

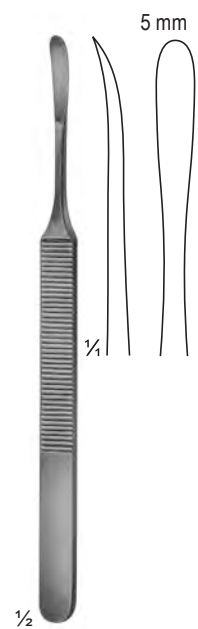

RS-035
 KONIG
 155 mm

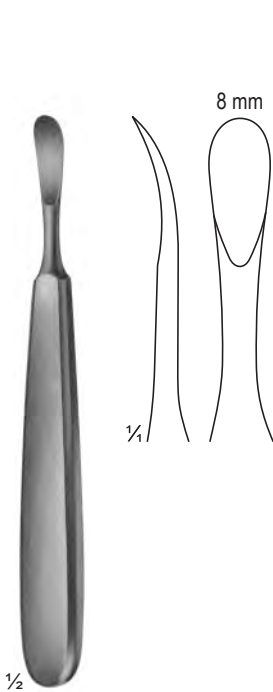

RS-036
 TRELAT
 150 mm

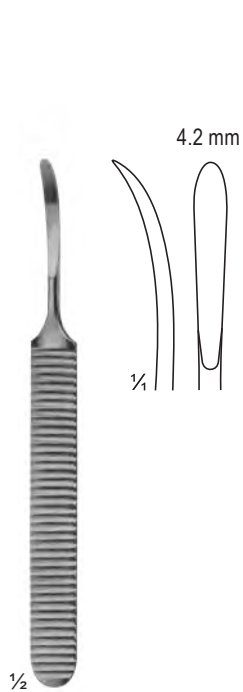

RS-037
 WILLIGER
 140 mm

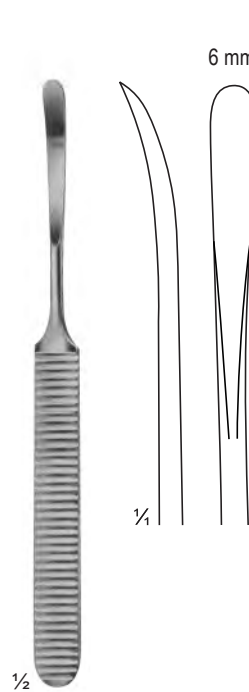

RS-038
 WILLIGER
 160 mm

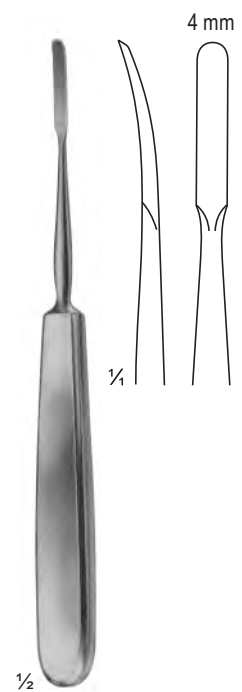

RS-039
 JOSEPH
 170 mm



RASPATORIES

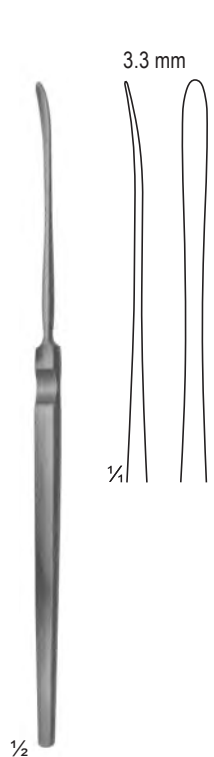

RS-040
HALLE
stumpf/blunt
180 mm



RS-041
FREER
stumpf/blunt
190 mm



RS-042
FREER
stumpf/sharp
190 mm

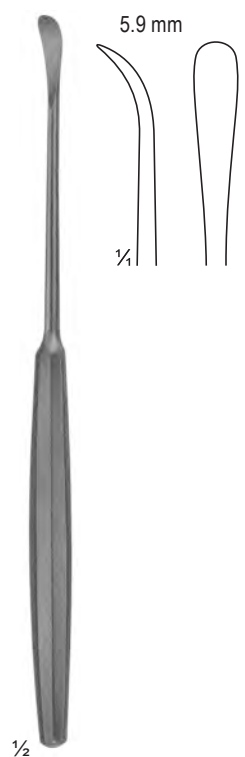

RS-043
SEWALL
stumpf/blunt
190 mm

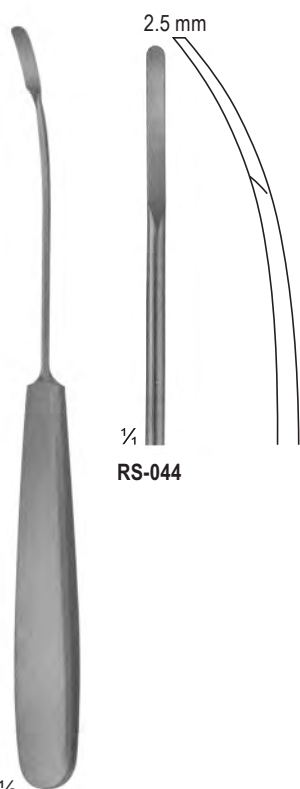

RS-044 - 046
205 mm

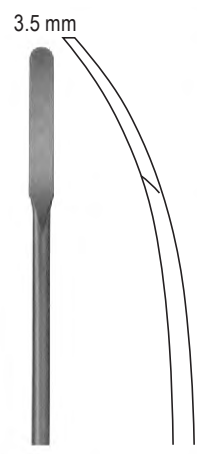

RS-045

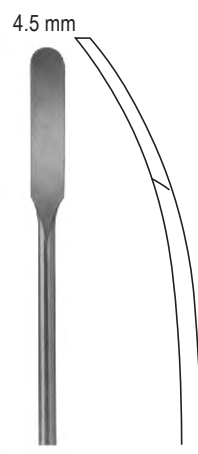

RS-046

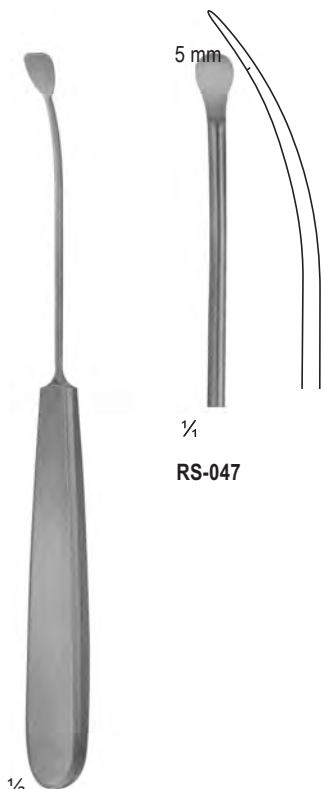

RS-047 - 048
PAULSEN
205 mm



RS-048

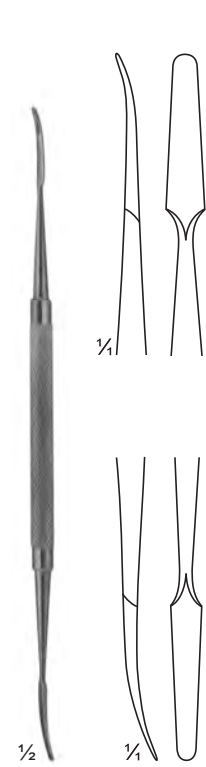

RS-049
KILLIAN
sharp/blunt
185 mm

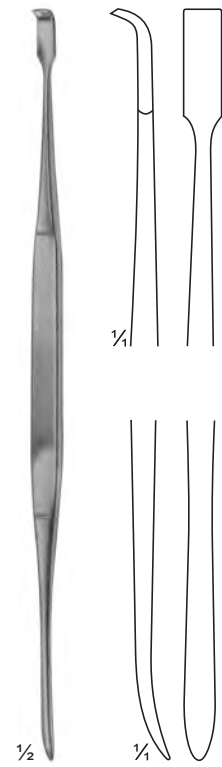

RS-050
HOWARTH
sharp/blunt
215 mm

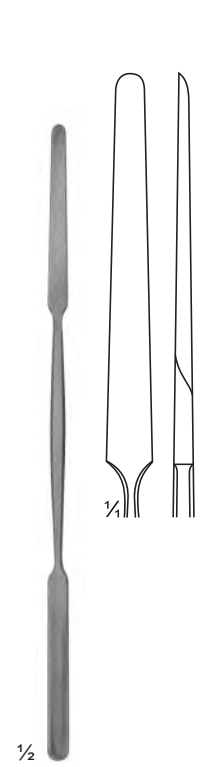

RS-051
KILLIAN
sharp/blunt
185 mm

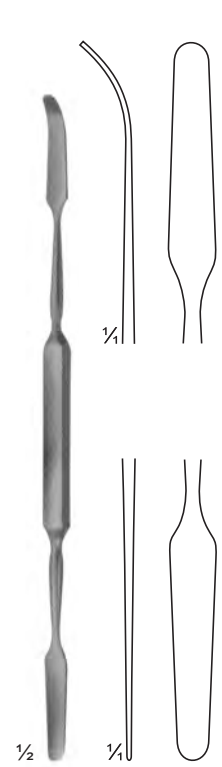

RS-052
MAC DONALD
blunt/blunt
185 mm

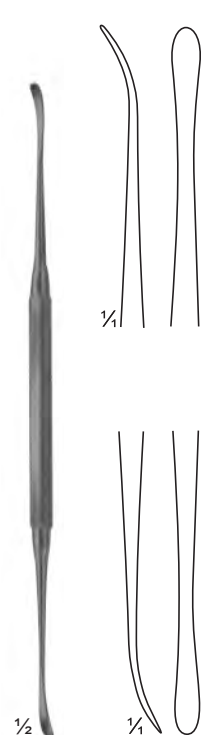

RS-053
FREER
sharp/blunt
185 mm

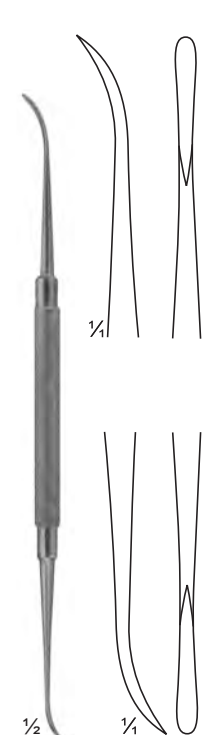

RS-054
FREER-YASARGIL
sharp/sharp
185 mm

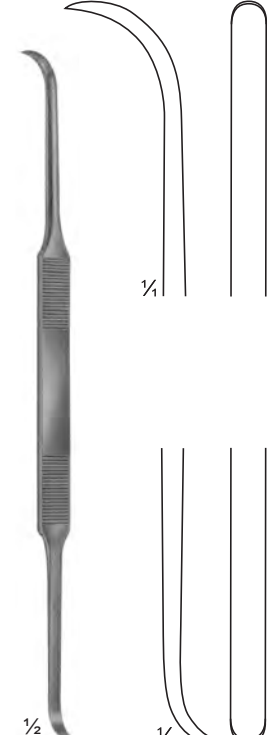

RS-055
COTTLE
sharp/sharp
200 mm

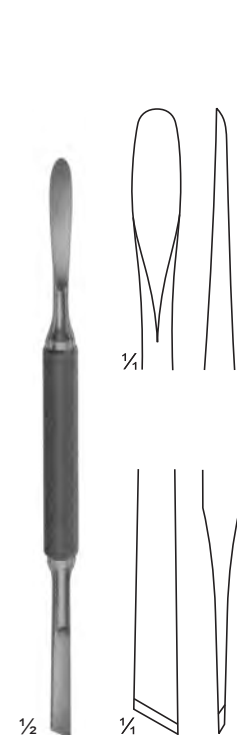

RS-056
MEAD
sharp/sharp
165 mm

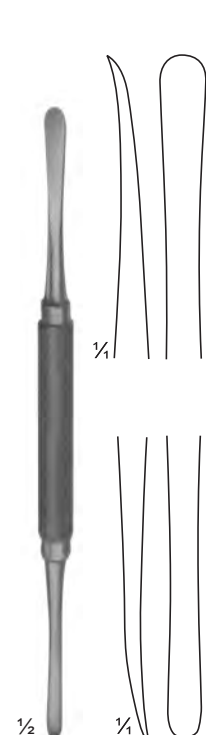

RS-057
MOLT
sharp/sharp
180 mm

RASPATORIES



RS-058 - 071
MANNERFET
155 mm



RS-058
4 mm



RS-059
7 mm



RS-060
9 mm



RS-063
6 mm



RS-064
6 mm



RS-065
8 mm



RS-061
3 mm



RS-062
6 mm



RS-066
4 mm



RS-067
5 mm



RS-068
6 mm



RS-069
4 mm
90°



RS-070
6 mm
90°



RS-071
3,5 mm
45°

6 mm

8 mm

8 mm

7 mm

7 mm

7 mm



RS-072 - 073
165 mm



RS-072



RS-073



RS-074 - 077
ADSON
170 mm



RS-074



RS-075



RS-076



RS-077

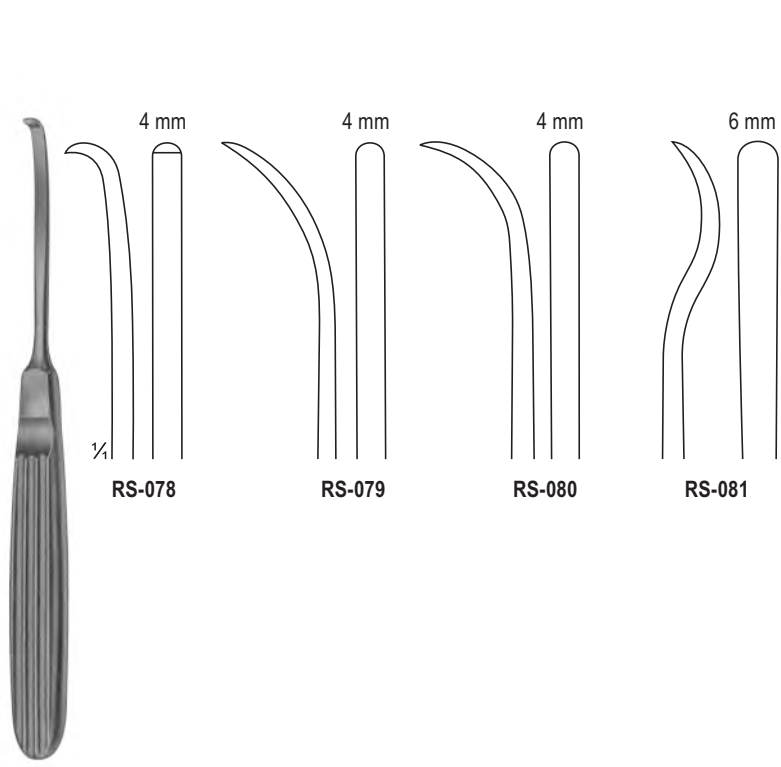

RS-078

RS-079

RS-080

RS-081

1/2
RS-078 - 081
MUHLING
170 mm

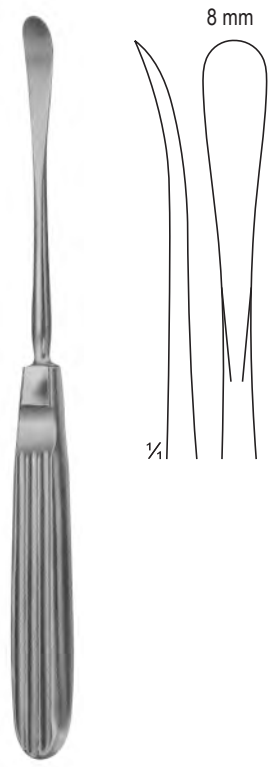

1/2
RS-082
COTTLE
175 mm

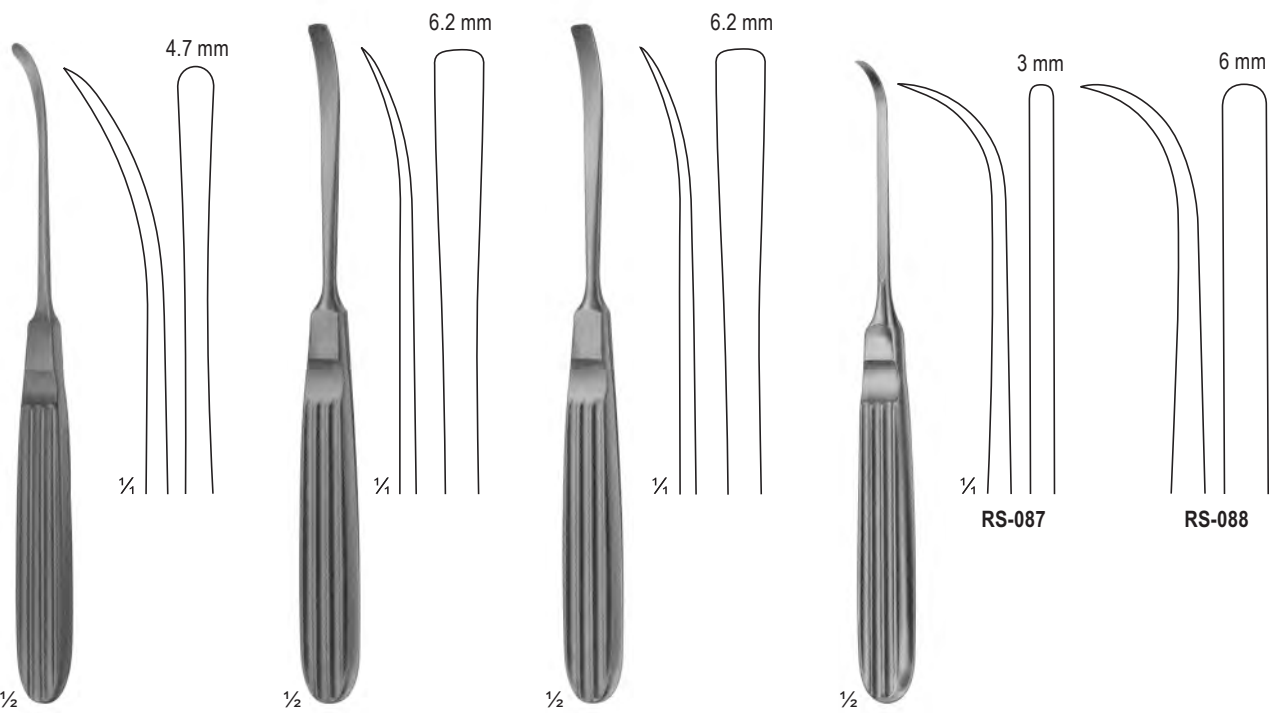

1/2
RS-083
LANDOT
175 mm

1/2
RS-084
CASPER
180 mm

1/2
RS-085
CASPER
180 mm

1/2
RS-086 - 088
170 mm

RS-087

RS-088



RASPATORIES

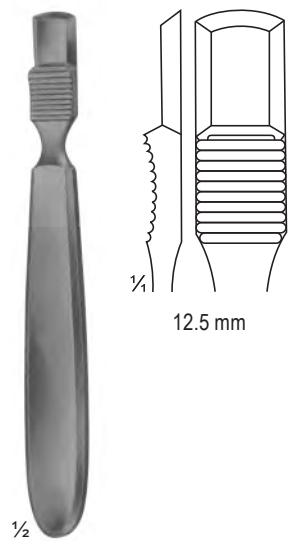

RS-089
FARABEU
140 mm

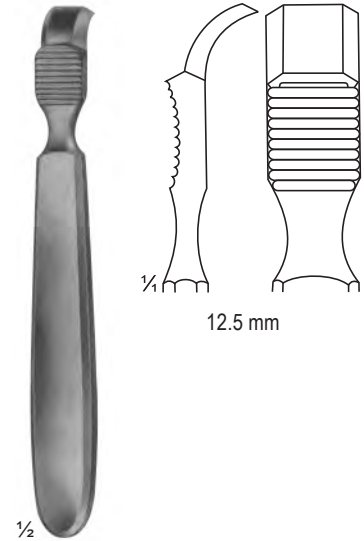

RS-090
FARABEU
140 mm

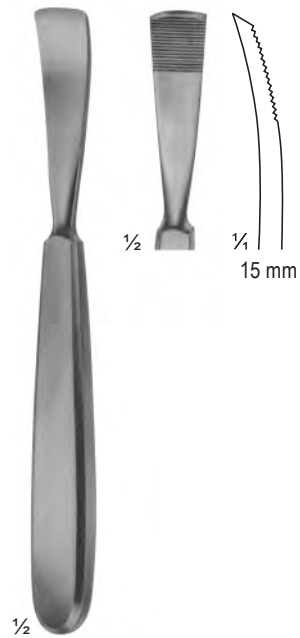

RS-091
JANSEN
165 mm

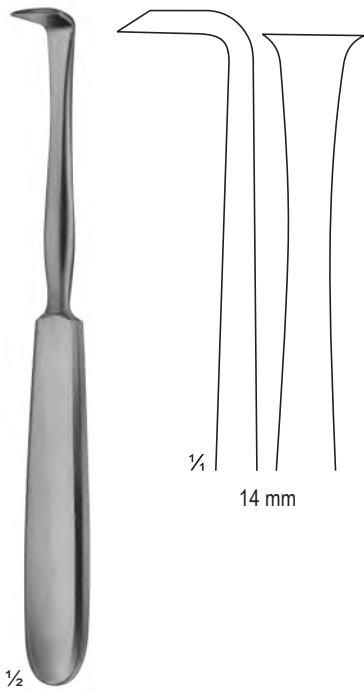

RS-092
LANGENBECK
180 mm

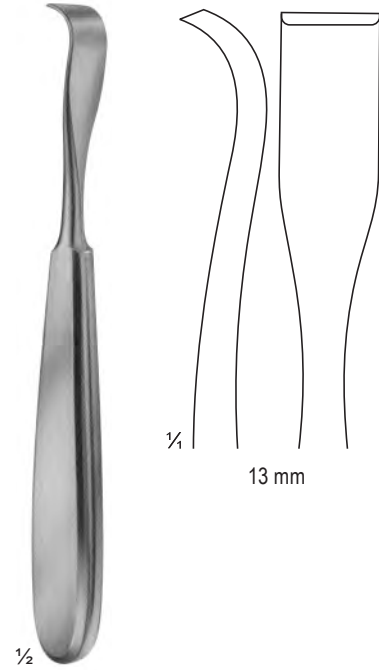

RS-093
SCHNEIDER
175 mm

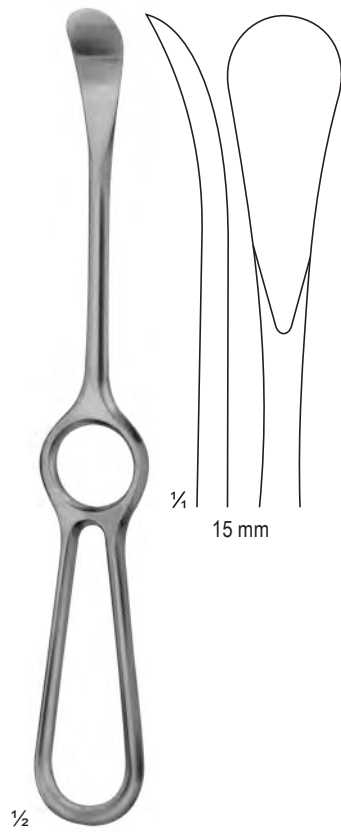

RS-094
SEDILLOT
215 mm

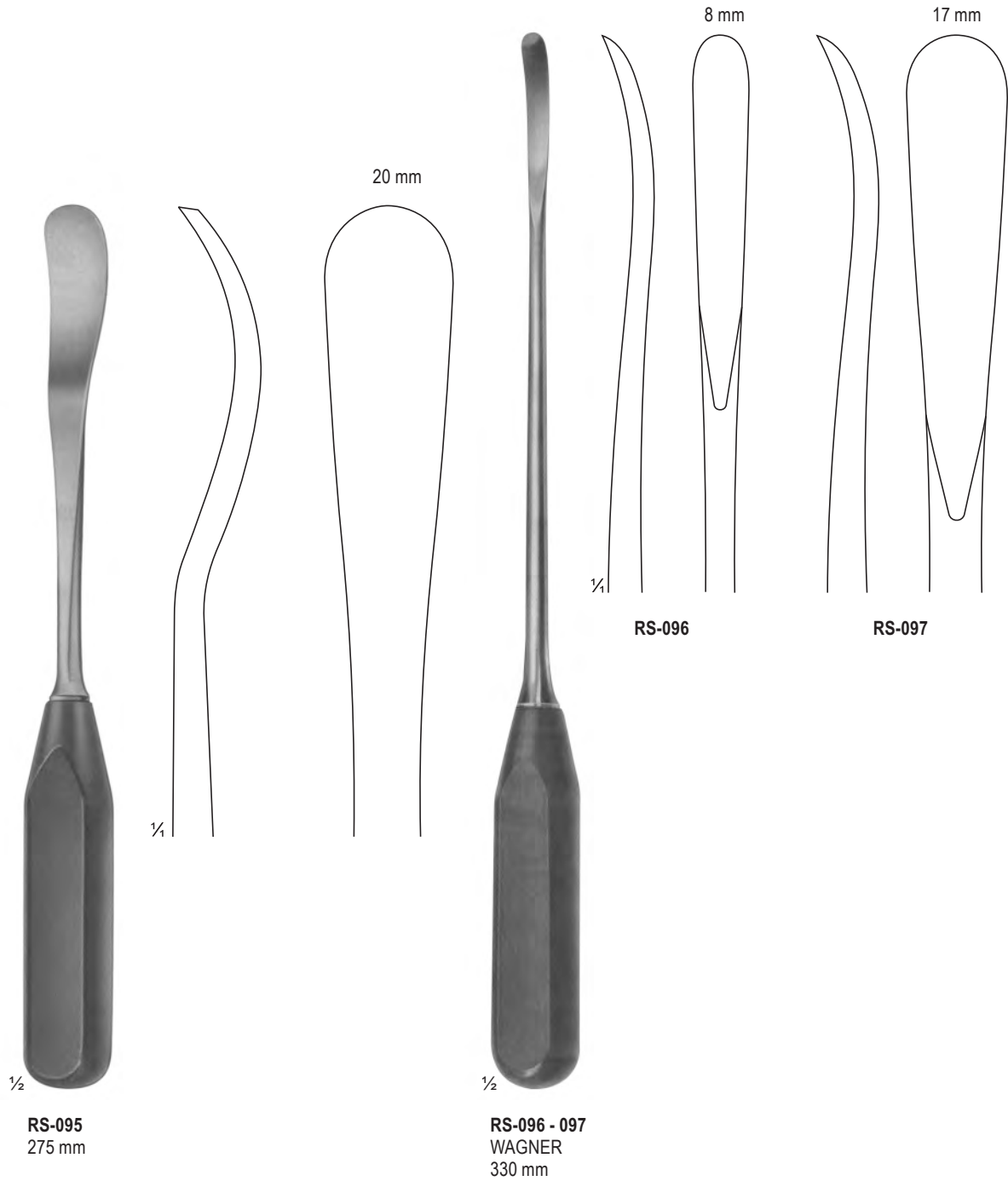



BONE CURETTES



RS-098
JACOBSON
140 mm

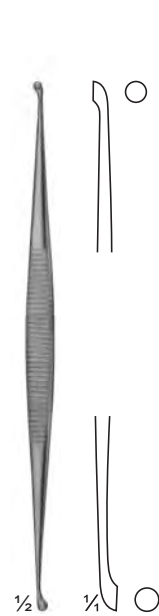

RS-099
MARTINI
140 mm

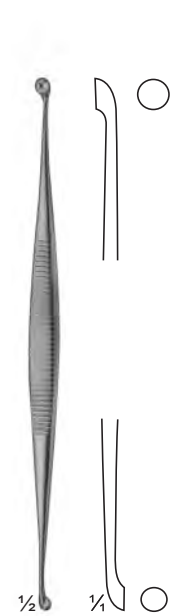

RS-100
MARTINI
140 mm



RS-101
WILLIGER
145 mm



RS-102
JANSEN
160 mm



RS-103
BARTH
180 mm

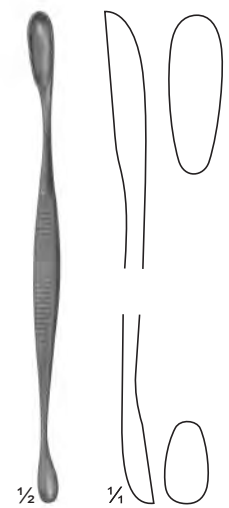

RS-104
VOLKMANN
130 mm

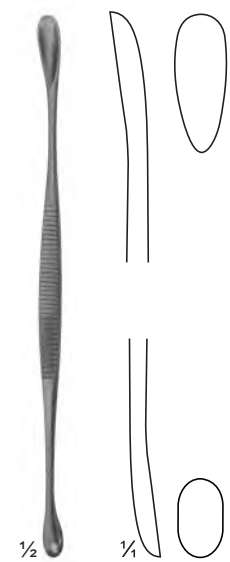

RS-105
VOLKMANN
145 mm

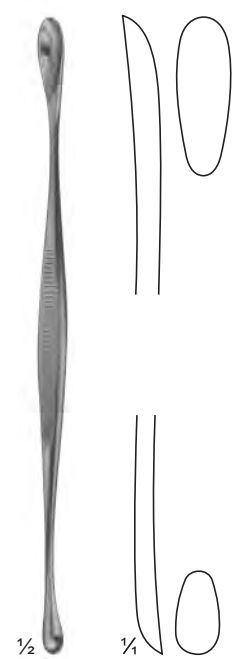

RS-106
VOLKMANN
170 mm



RS-107
JANSEN
160 mm



RS-108
HEMINGWAY
170 mm

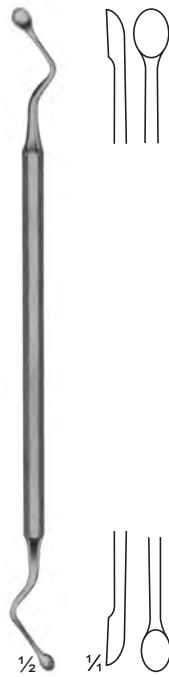

RS-109
HEMINGWAY
175 mm



RS-110
LUCAS
180 mm



RS-111
LUCAS
185 mm

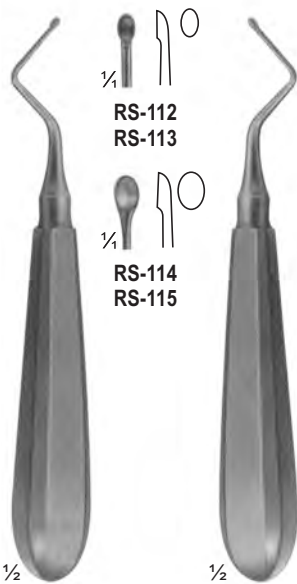

RS-112 - 113
KERPEL
145 mm



RS-114 - 115
KERPEL
145 mm

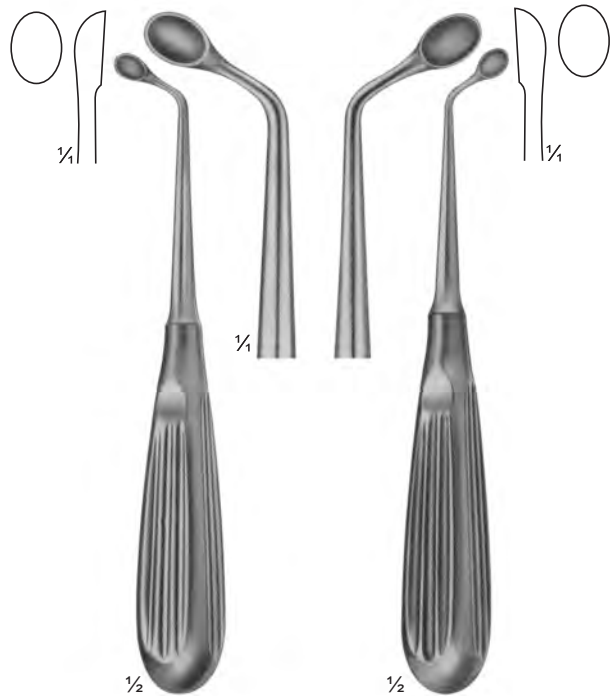

RS-116
UFFENDORDE
170 mm



RS-117
UFFENDORDE
170 mm

BONE CURETTES



RS-118 - 124
BRUNS
165 mm



RS-125 - 131
SCHEDE
170 mm

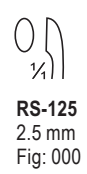

RS-132 - 141
VOLKMANN
170 mm

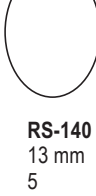

RS-142 - 143
WILLIGER
170 mm



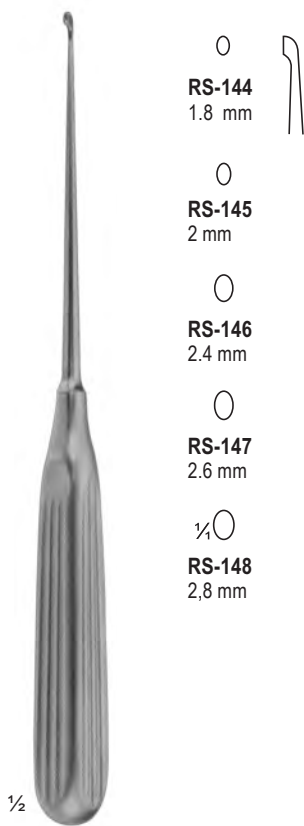

○
RS-144
1.8 mm

○
RS-145
2 mm

○
RS-146
2.4 mm

○
RS-147
2.6 mm

¼○
RS-148
2.8 mm

½
RS-144 - 148
LEMPERT
215 mm

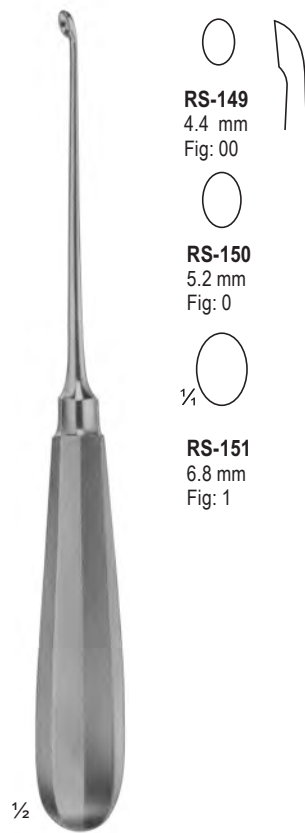

○
RS-149
4.4 mm
Fig: 00

○
RS-150
5.2 mm
Fig: 0

¼○
RS-151
6.8 mm
Fig: 1

½
RS-149 - 151
HALLE
215 mm

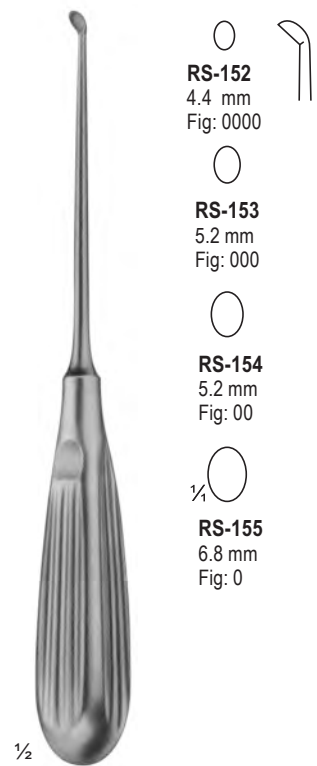

○
RS-152
4.4 mm
Fig: 0000

○
RS-153
5.2 mm
Fig: 000

○
RS-154
5.2 mm
Fig: 00

¼○
RS-155
6.8 mm
Fig: 0

½
RS-152 - 155
DAUBENSPECK
200 mm



BONE CURETTES



RS-156
3.6 mm
Fig: 000

RS-157
4.4 mm
Fig: 00

RS-158
5.2 mm
Fig: 0

RS-159
6.8 mm
Fig: 1

$\frac{1}{2}$
RS-156 - 159
250 mm



RS-160
3.6 mm
Fig: 000

RS-161
4.4 mm
Fig: 00

RS-162
5.2 mm
Fig: 0



RS-163
6.8 mm
Fig: 1

$\frac{1}{2}$
RS-160 - 163
250 mm



RS-164
3 mm

RS-165
4 mm

RS-166
5 mm

$\frac{1}{2}$
RS-164 - 166
BUSHE
250 mm

$\frac{1}{4}$ O
Fig. 1
RS-167

$\frac{1}{4}$ O
Fig. 1
RS-173

$\frac{1}{4}$ O
Fig. 1
RS-179

O
Fig. 2
RS-168

O
Fig. 2
RS-174

O
Fig. 2
RS-180

O
Fig. 3
RS-169

O
Fig. 3
RS-175

O
Fig. 3
RS-181

O
Fig. 4
RS-170

O
Fig. 4
RS-176

O
Fig. 4
RS-182



O
Fig. 5
RS-171

O
Fig. 5
RS-177

O
Fig. 5
RS-183

O
Fig. 6
RS-172

O
Fig. 6
RS-178

O
Fig. 6
RS-184



MODELL USA
Oval, With Hollow Handle
RS-167 - 172
165 mm

MODELL USA
Oval, With Hollow Handle
RS-173 - 178
165 mm

MODELL USA
Oval, With Hollow Handle
RS-179 - 184
16 mm



BONE RASPS

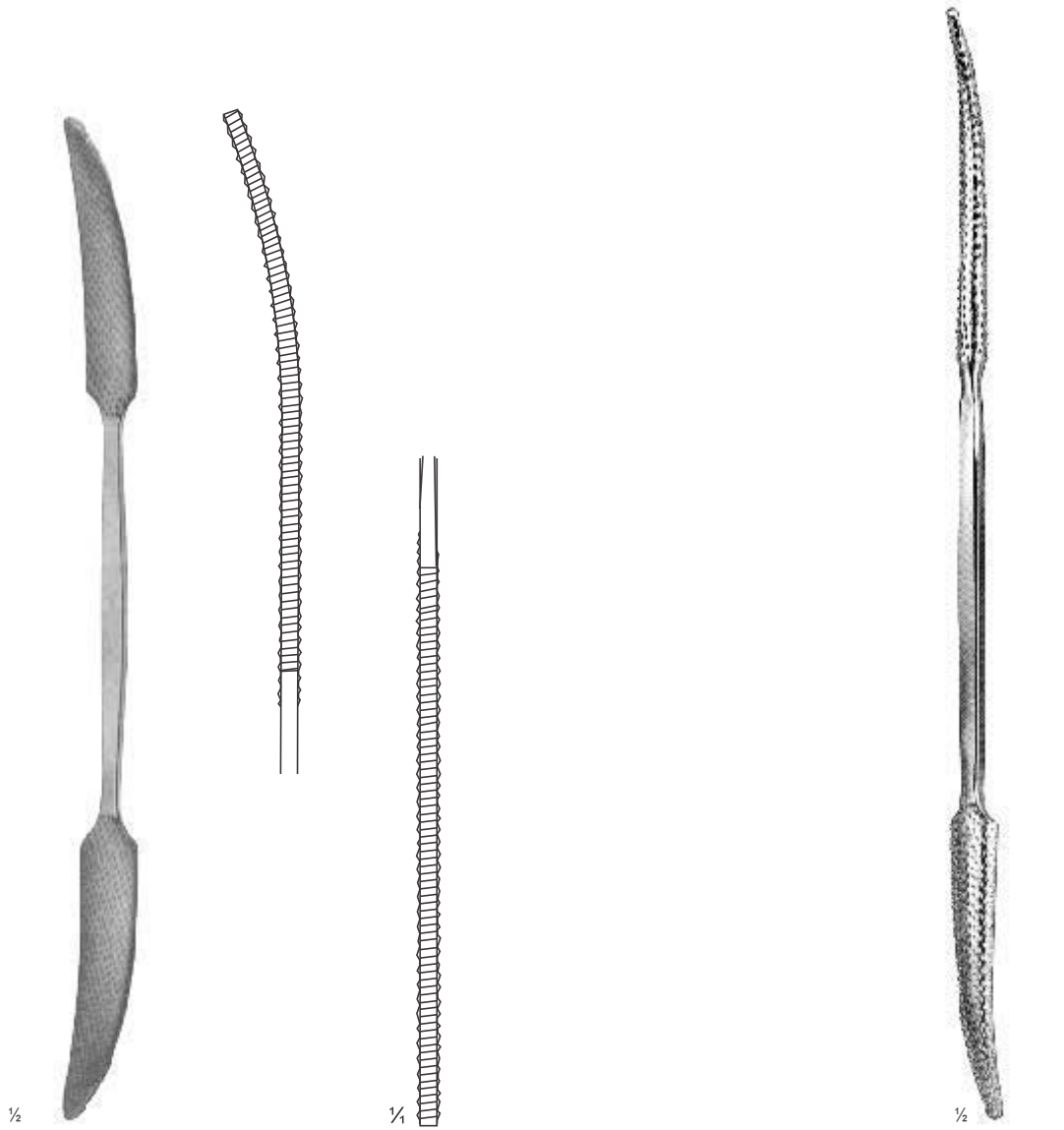

Putti
RS-185
27 cm
Curved / straight

Putti
RS-186
30 cm
Round / semi round

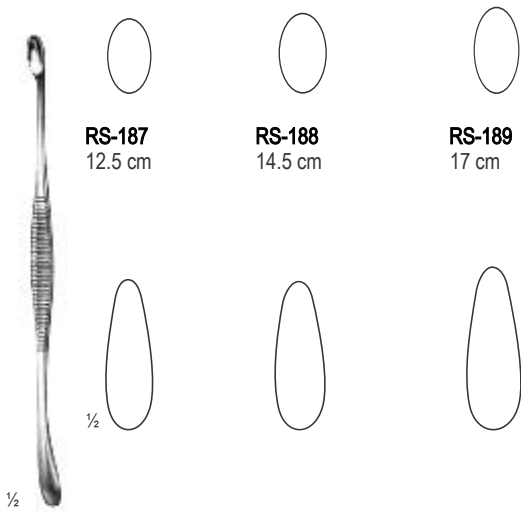

RS-187
12.5 cm

RS-188
14.5 cm

RS-189
17 cm

Volkman
RS-187 - 189
12.5 cm

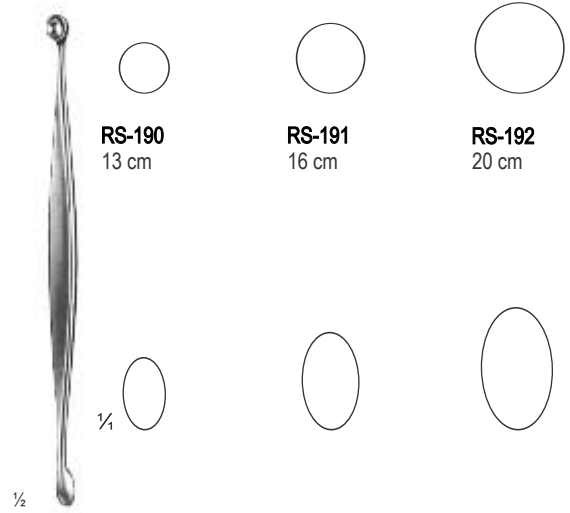

RS-190
13 cm

RS-191
16 cm

RS-192
20 cm

Volkman
RS-190 - 192
13 cm

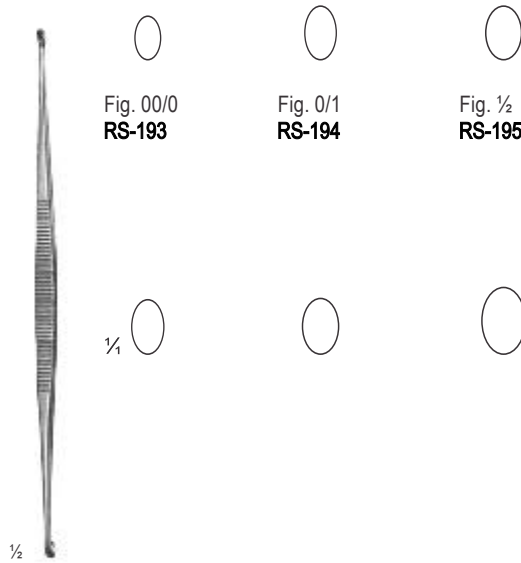

Fig. 00/0
RS-193

Fig. 0/1
RS-194

Fig. 1/2
RS-195

Williger
RS-193 - 195
14 cm

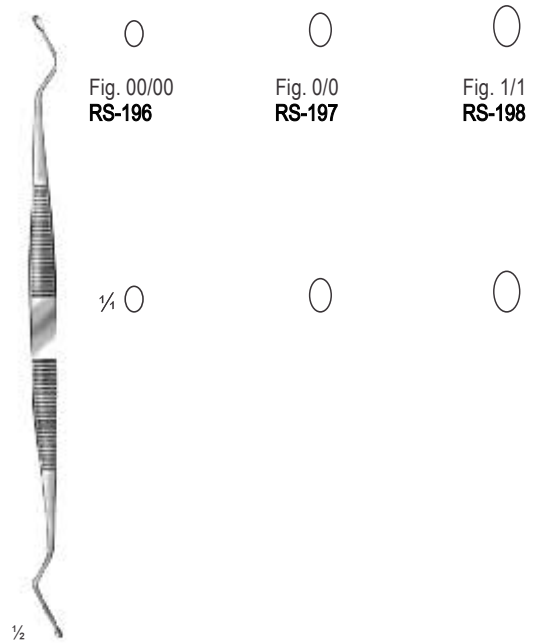

Fig. 00/00
RS-196

Fig. 0/0
RS-197

Fig. 1/1
RS-198

Williger
RS-196 - 198
16.5 cm
Oval



RASPATORIES, ELEVATORS



Key
RS-199 6 mm
RS-200 12 mm
RS-201 19 mm
RS-202 25 mm 19 cm
Raspatory



Cushing
RS-203
19 cm, 6 mm
Elevator



Cushing
RS-204
19 cm 15 mm
Raspatory



Cushing
RS-205
19 cm 15 mm
Raspatory



Quervain
RS-206
20 cm
Elevator



RS-207
19 cm
6 mm
Elevator
hard-pressed handle



Adson
RS-208
17 cm, 8 mm
Elevator



Adson
RS-209
17 cm, 6 mm
Raspatory



Adson
RS-210
17 cm, 8 mm
Raspatory



Adson
RS-211
17 cm, 6 mm
Raspatory



Cobb
RS-212 8 mm
RS-213 10 mm
RS-214 13 mm
RS-215 19 mm
RS-216 25 mm
RS-217 32 mm
28 cm
Elevator

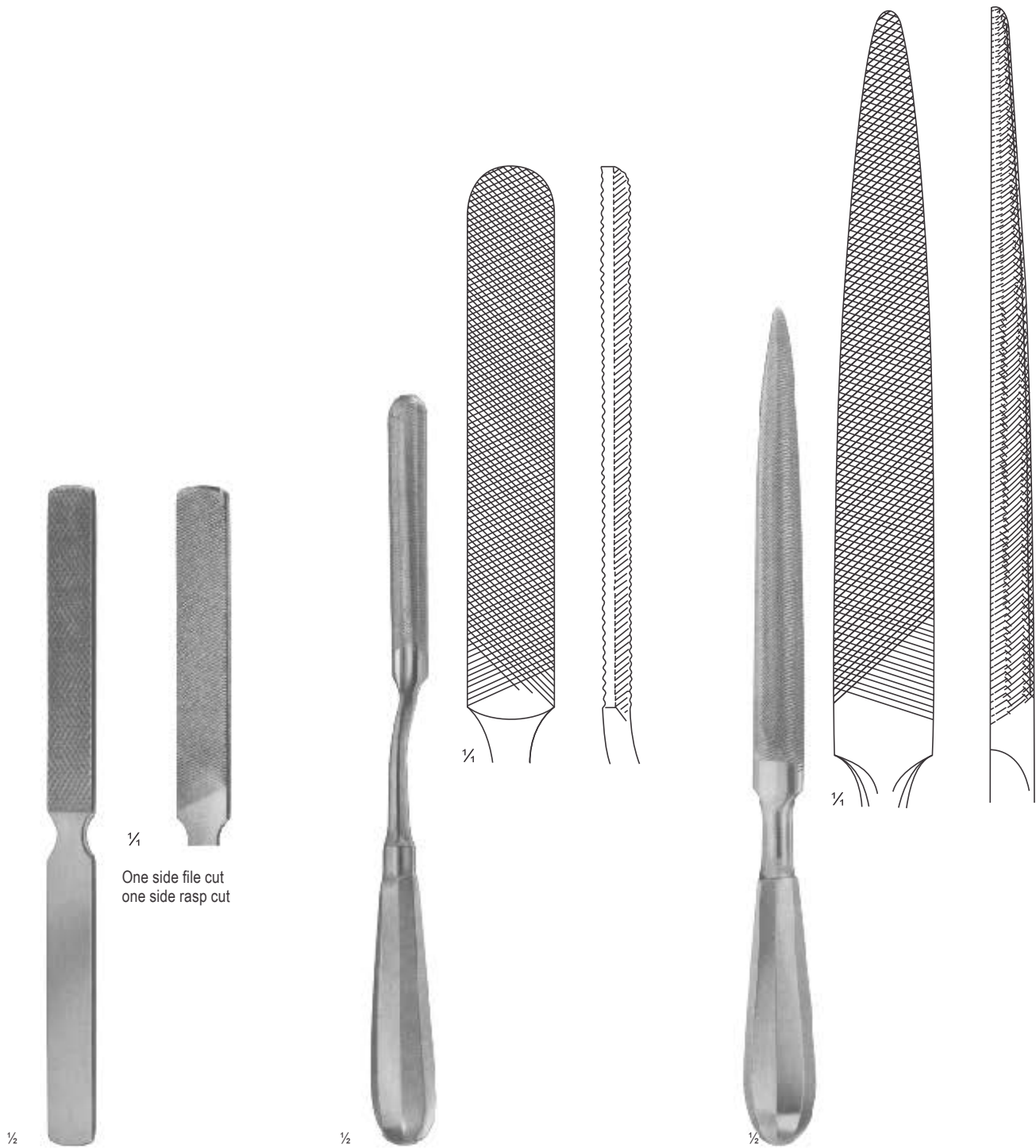

1/4
One side file cut
one side rasp cut

RS-218
22 cm
Flat, solid

RS-219
25 cm
Semi round, with
hollow handle

RS-220
28 cm
Semi round,
with hollow handle



ELEVATORS



1/2

Adson
RS-221 - 224

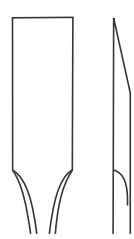

RS-221
17 cm

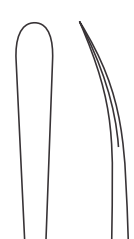

RS-222
17.5 cm

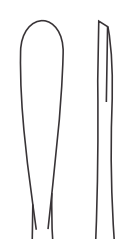

RS-223
17.5 cm

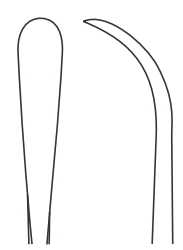

RS-224
17 cm



1/4

Langenbeck
RS-225 - 228
Solid

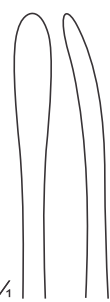

RS-225
17 cm
5 mm

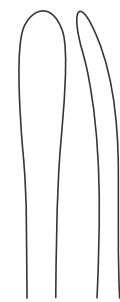

RS-226
17 cm
7 mm



RS-227
19.5 cm
8 mm



RS-228
19.5 cm
10 mm



1/2

Langenbeck
RS-229 - 230

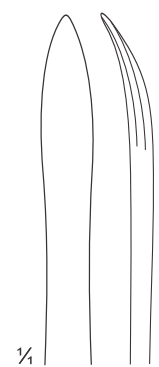

1/4

RS-229
19.5 cm
7 mm

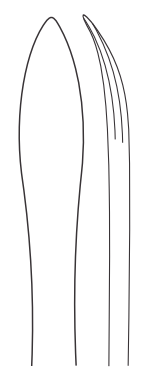

RS-230
19.5 cm
10 mm

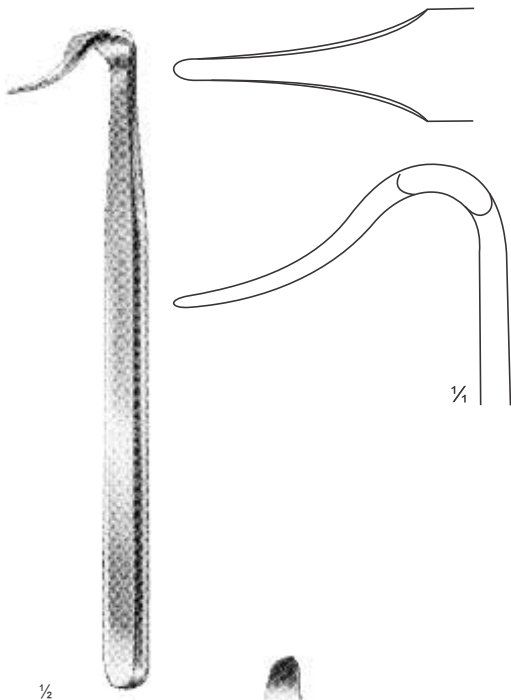

Blount
RS-231
17.5 cm
Knee retractor

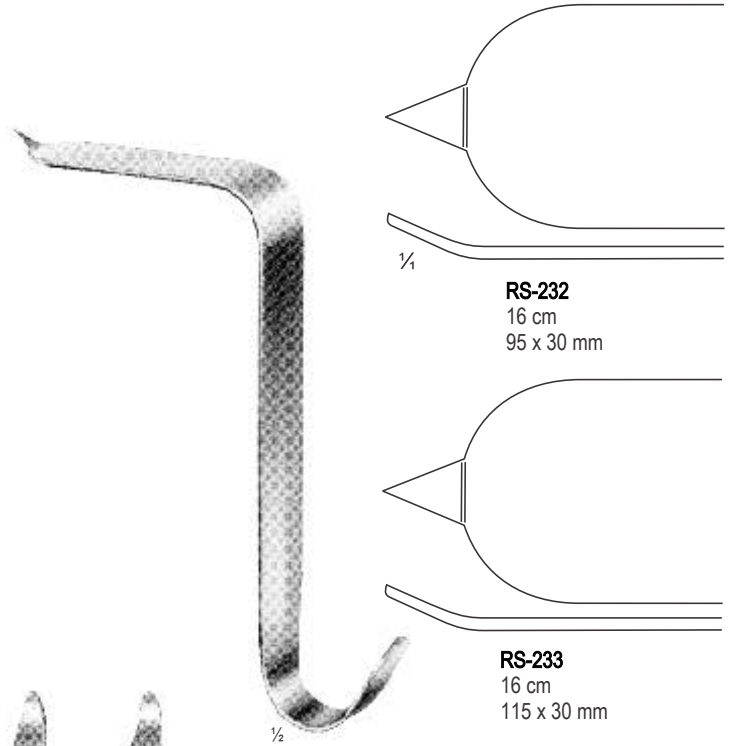

RS-232
16 cm
95 x 30 mm

RS-233
16 cm
115 x 30 mm

Taylor
RS-232 - 233
16 cm
Spinal retractor



Blount
RS-234
26.5 cm
Blunt
39 mm
Knee retractor



Blount
RS-235
26.5 cm
47mm
Knee retractor



BONE LEVERS



½
Bone Lever
RS-236
Narrow Tip
6 mm

½
Bone Lever
RS-237
Narrow Tip
8 mm

½
Hohmann
RS-238
Wide round tip 24 mm
Length: 27 cm

½
Hohmann
RS-239
Wide tip 22 mm
Length: 25.5 cm

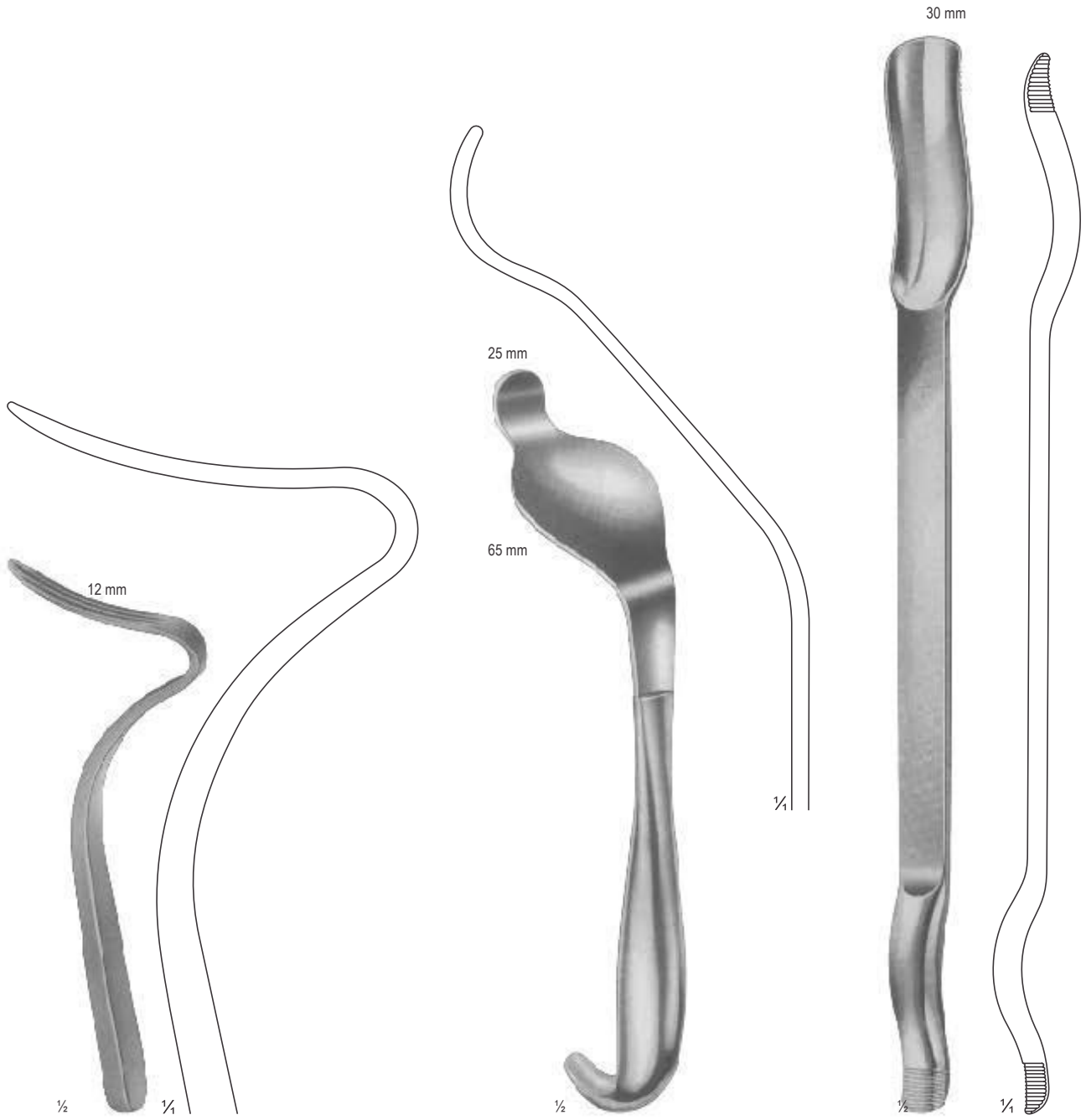

Tager
RS-240
 17.5 cm
 Bone lever for
 angle joint operations

Bennett
RS-241
 23.5 cm

Murphy-Lane
RS-242
 34 cm
 Luxation lever