

Page
01–51

o Ent Surgery



¼

ZÖLLNER
VW-001 - 006
set for adults, black

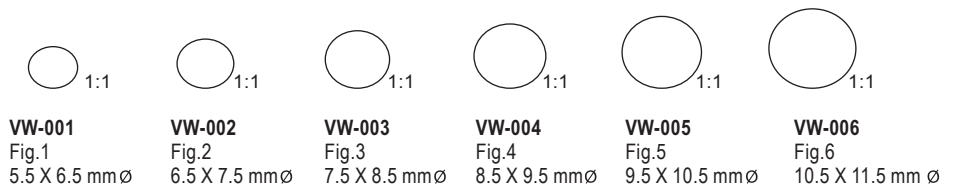

¼

POLITZER
VW-007 - 010
set for adults

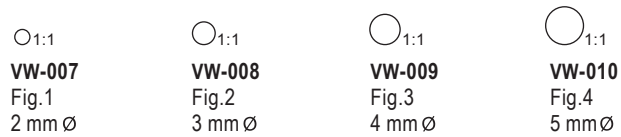

¼

BOUCHERON
VW-011 - 013
set for children



¼

HARTMANN
VW-014 - 017
set for adults

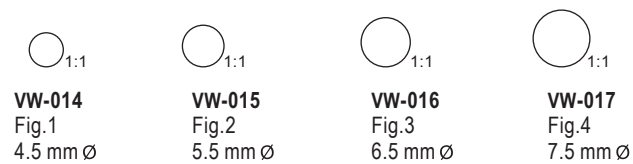

EAR CURETTES



BUCK
VW-018 - 033
 Blunt
 Sharp
 165 mm - 6½"

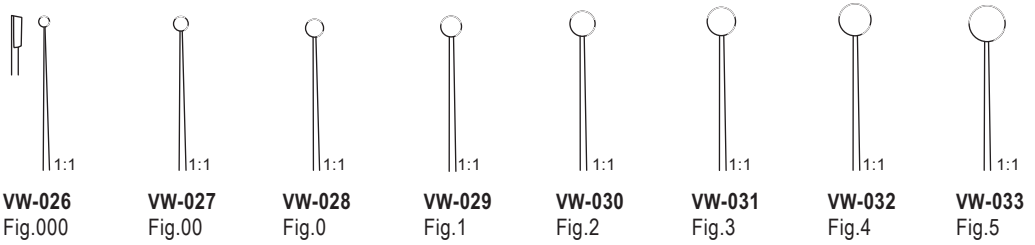
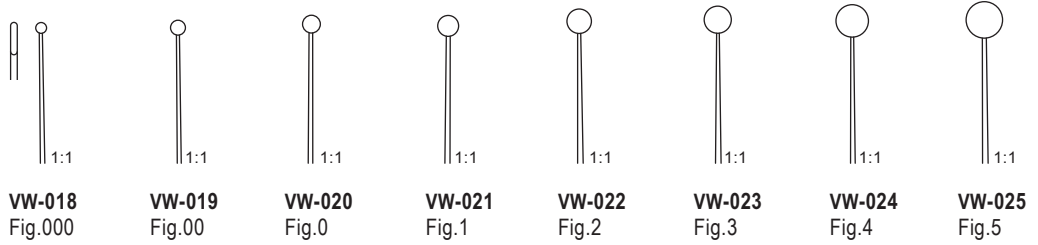

BUCK
VW-034 - 049
 Curved, blunt
 Curved, sharp
 165 mm - 6½"

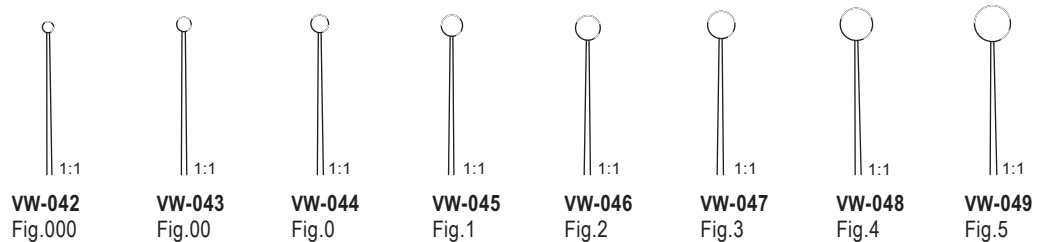
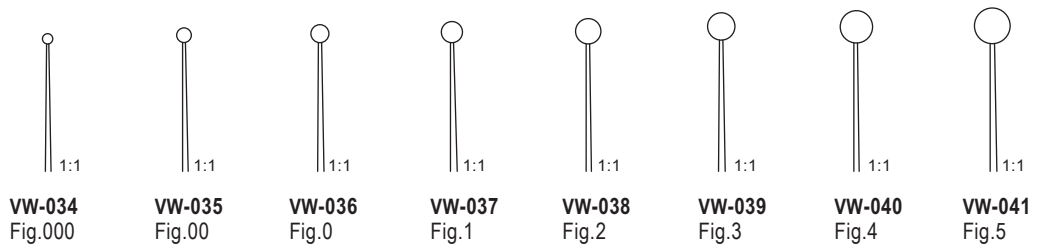

Picture Show The Outer Diameter

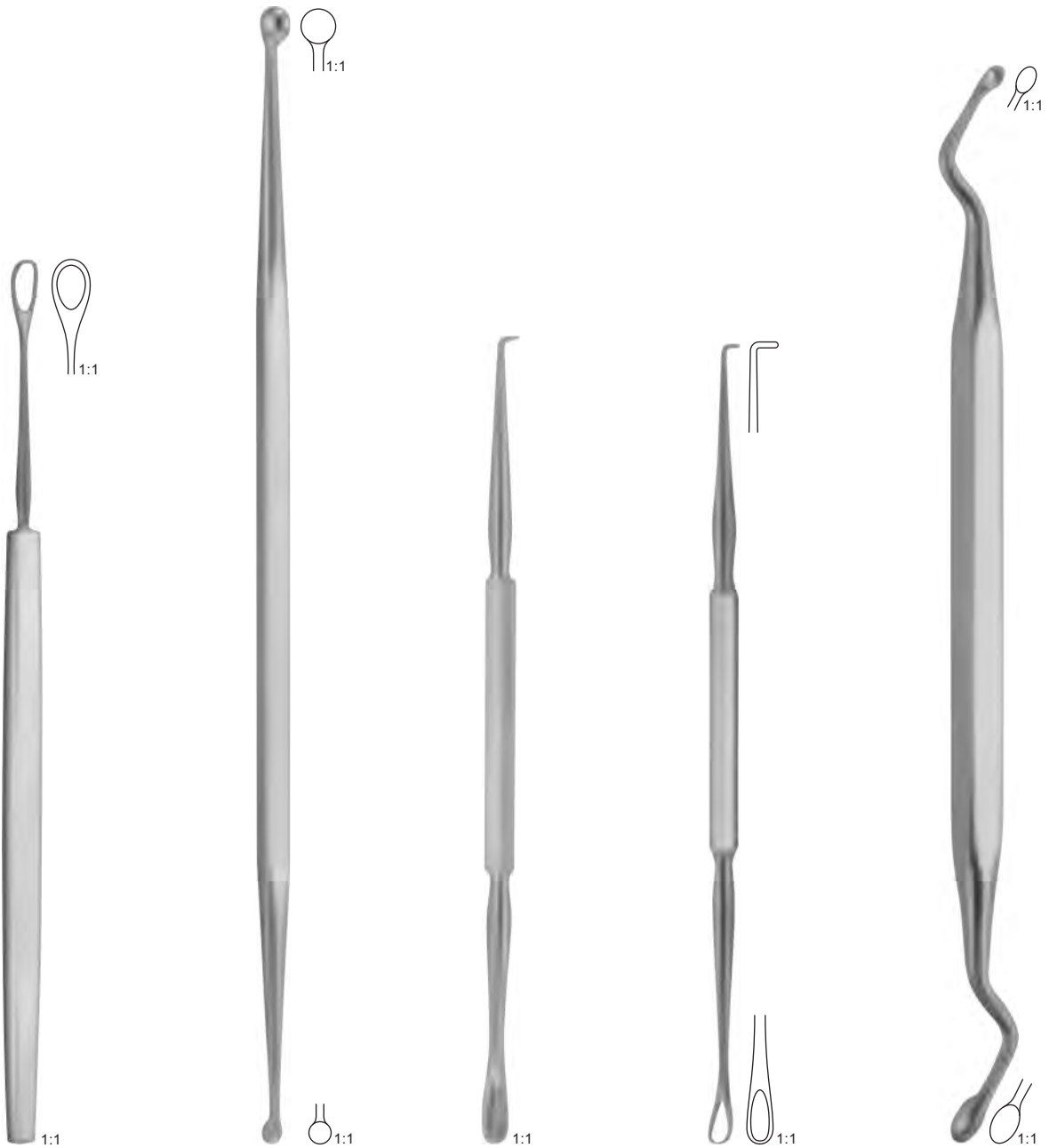

**LANGENBECK
VW-050**
Blunt
130 mm - 5"

**JANSEN
VW-051**
Sharp
170 mm - 6 3/4"

**GROSS
VW-052**
Sharp, not fenestrated
120 mm - 4 3/4"

VW-053
Blunt, fenestrated
120 mm - 4 3/4"

**JANSEN
VW-054**
Sharp
160 mm - 6 1/4"



EAR LOOPS – HOOKS



BILLEAU
VW-055 - 057
165 mm - 6½"



VW-055

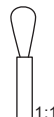

VW-056



VW-057



LUCAE
VW-058 - 060
140 mm - 5½"



VW-058



VW-059



VW-060



WAGENER
VW-061 - 067
140 mm - 5½"



VW-061



VW-062



VW-063



VW-064



VW-065



VW-066



VW-067

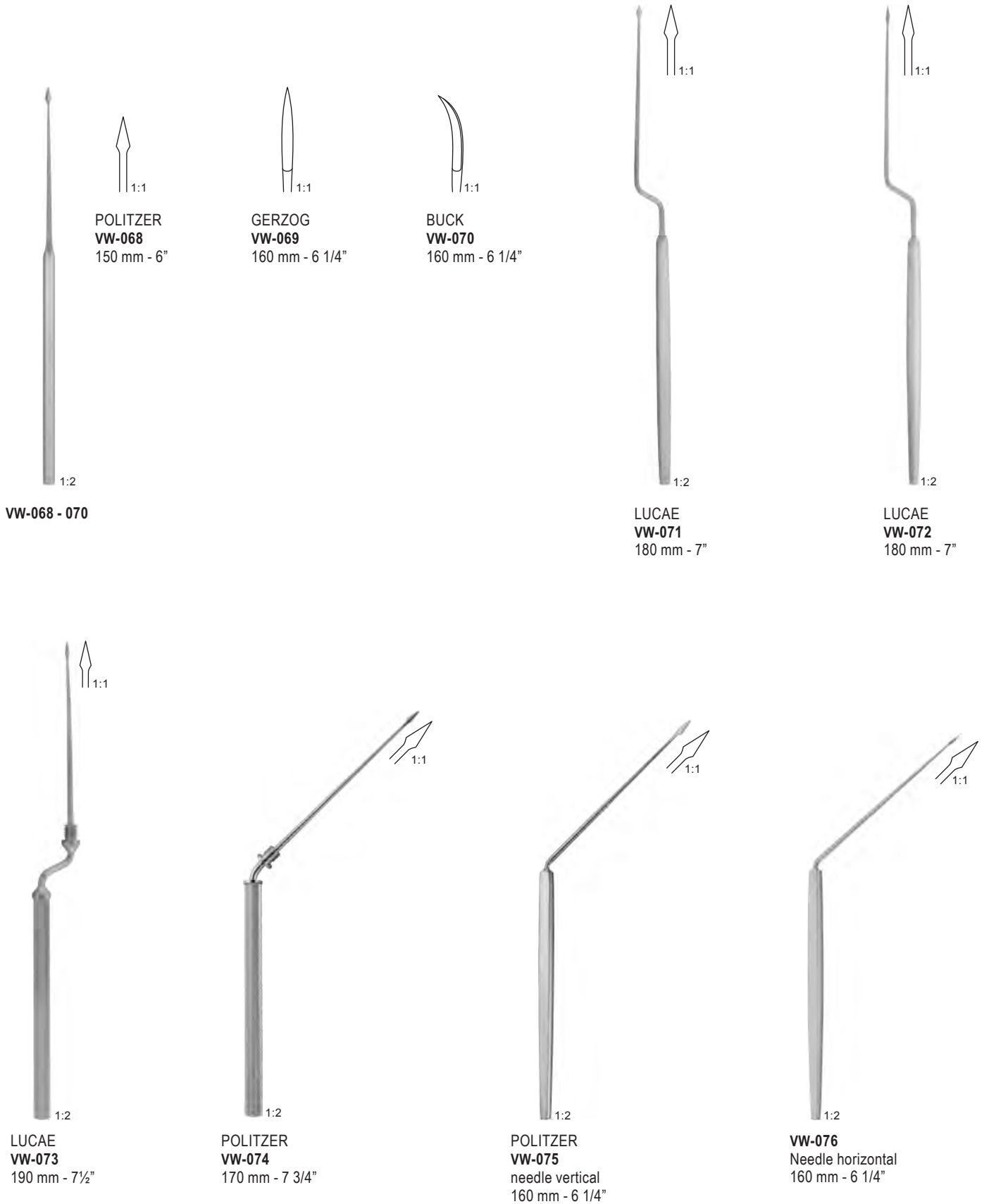

EAR FORCEPS AND MICRO EAR FORCEPS

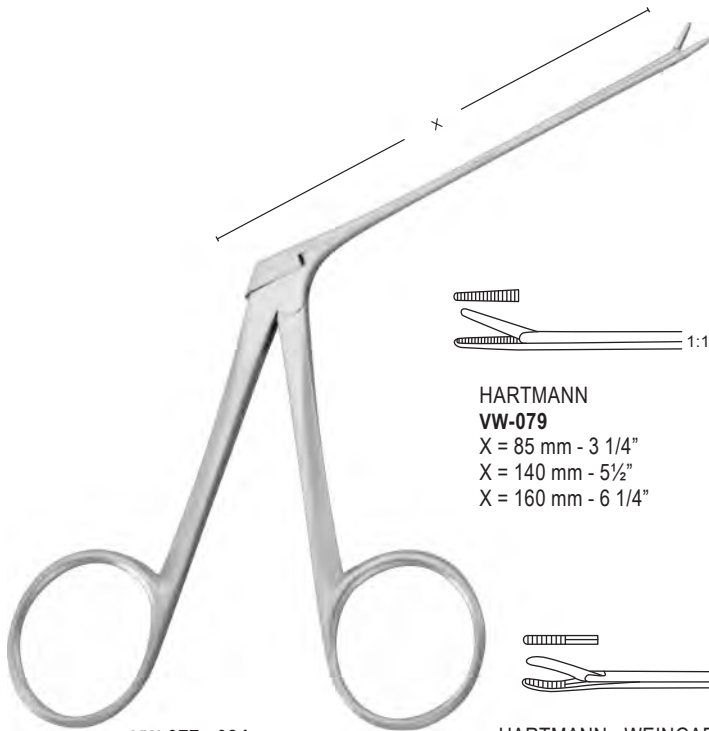

VW-077 - 084

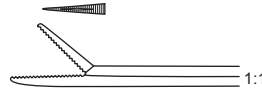

HARTMANN - WULLSTEIN
VW-077
X = 85 mm - 3 1/4"



HARTMANN - WULLSTEIN
VW-078
X = 85 mm - 3 1/4" 1 mm ø



HARTMANN
VW-079
X = 85 mm - 3 1/4"
X = 140 mm - 5 1/2"
X = 160 mm - 6 1/4"

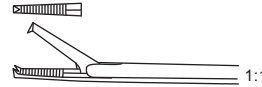

HARTMANN
VW-080
X = 85 mm - 3 1/4"
X = 140 mm - 5 1/2"

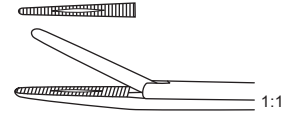

HARTMANN - NOYES
VW-081
X = 90 mm - 3 1/2"



HARTMANN - WEINGARTNER
VW-082
X = 85 mm - 3 1/4"



HARTMANN
VW-083
X = 85 mm - 3 1/4"
2.0 mm ø
2.5 mm ø
3.0 mm ø

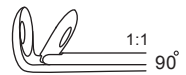
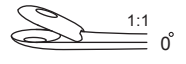

STRUEMPEL
VW-084
X = 85 mm - 3 1/4"

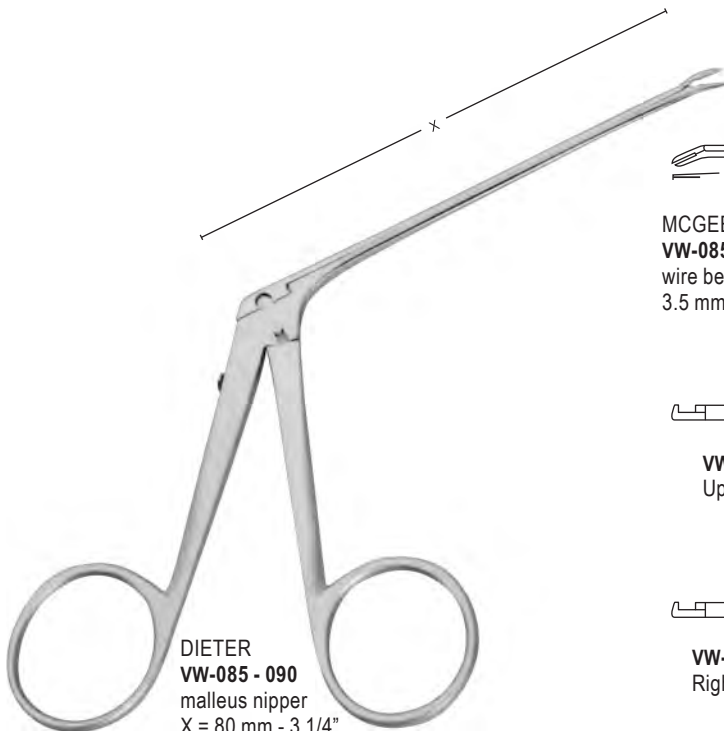

DIETER
VW-085 - 090
malleus nipper
X = 80 mm - 3 1/4"



MCGEE
VW-085
wire bending forceps
3.5 mm X 0.8 mm



FULLER
VW-086
introducing forceps
for teflon prosthesis
80 mm - 3 1/4"



VW-087
Up - cutting



VW-088
Down - cutting

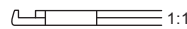

VW-089
Right - cutting



VW-090
Left - cutting



VW-091 - 095

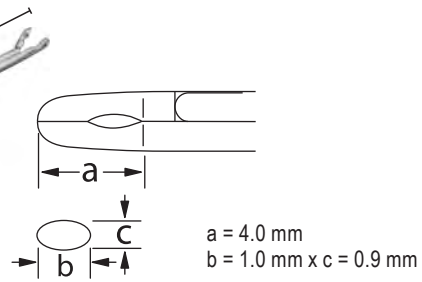

VW-091
Straight, oval
X = 75 mm - 3"



VW-092
Curved upwards, oval
X = 75 mm - 3"



VW-093
Curved to left, oval
X = 75 mm - 3"



VW-094
Curved to right, oval
X = 75 mm - 3"



VW-095
Curved downwards, oval
X = 75 mm - 3"



BELUCCI
VW-096 - 100

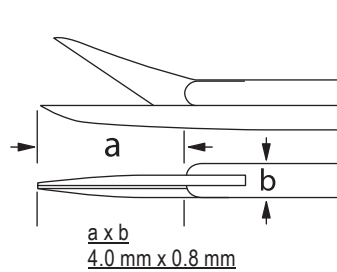

VW-096
Straight, sharp/sharp
X = 75 mm - 3"



VW-097
Curved upwards, blunt/blunt
X = 75 mm - 3"



VW-098
Curved to right, sharp/sharp
X = 75 mm - 3"



VW-099
Curved to left, sharp/sharp
X = 75 mm - 3"



VW-100
straight, sharp/blunt
X = 75 mm - 3"



MICRO EAR RASPATORIES AND PROBES
EAR SICKLEKNIVES – CURRCULAR CUTTING KNIFE



PLESTER
VW-101 - 106
160 mm - 6 1/4"



1:1
WIRE GUIDE
VW-101



1:1
RASPATORY
VW-102



1:1
RASPATORY
VW-103
1.8 mm



1:1
VW-104
Dissector, double
curved right



1:1
VW-105
Instrument for placing
wire prosthesis



1:1
VW-106
Dissector, double
curved left



ROSEN
VW-107 - 113
160 mm - 6 1/4"

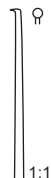

1:1
VW-107
Circular cutting knife
1.5 mm \varnothing 90°



1:1
VW-108
Tympanum knife
45°



1:1
VW-109
Lancet knife
45°



1:1
VW-110
Lancet knife

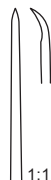

1:1
RASPATORY
VW-111
Zollner
1 mm



1:1
VW-112
Sickle knife,
slightly curved



1:1
VW-113
discision knife,
straight curved



VW-114 - 119



VW-114
Needle fine, straight, sharp
160 mm - 6 1/4"

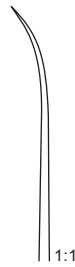

VW-115
Needle, slightly curved, sharp
160 mm - 6 1/4"



VW-116
Needle, strong curved, sharp
160 mm - 6 1/4"

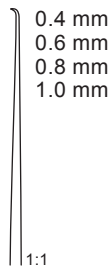

SHAMBAUGH
VW-117
45° Hook, angled
160 mm - 6 1/4"



PLESTER
VW-118
0.4 mm - 90°
foot plate hook, angled, blunt
160 mm - 6 1/4"



PLESTER
VW-119
0.4 mm - 45°
Antrum hook, angled, blunt
160 mm - 6 1/4"



VW-120 - 123



FISCH
VW-120
Angled to the right
155 mm - 6"



VW-121
Angled to the left
155 mm - 6"

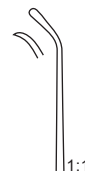

VW-122
Angled to the right
155 mm - 6"



VW-123
Angled to the left
155 mm - 6"



MICRO EAR – SPOONS



**HOUSE
VW-124**
spoon, strong curved
spoon, slightly curves
170 mm - 6 3/4"



**SHEA
VW-125**
straight
160 mm - 6 1/4"
1.5 mm X 2.5 mm



**SHEA
VW-126**
curved
160 mm - 6 1/4"
1.5 mm X 2.5 mm



1:2
CITELLI
VW-127 - 129
 X = 60 mm
 170 mm - 6 3/4"

VW-127
 1.5 mm

VW-128
 2.2 mm

VW-129
 3.0 mm

1:2
VW-130 - 133
 200 mm - 8"
 X = 80 mm



VW-130
 3 X 3 mm

VW-131
 4 X 4 mm

VW-132
 5 X 5 mm

VW-133
 6 X 6 mm

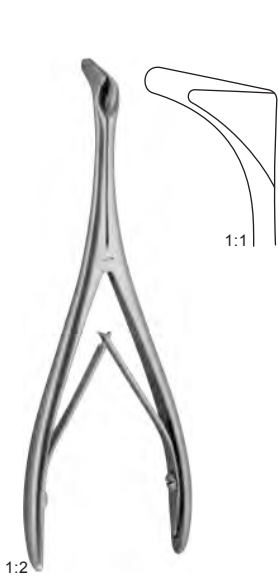
NASAL SPECULA



TIECK - HALLE
VW-134
for babies
135 mm - 5 1/4"



BECKMANN
VW-135
150 mm - 6"

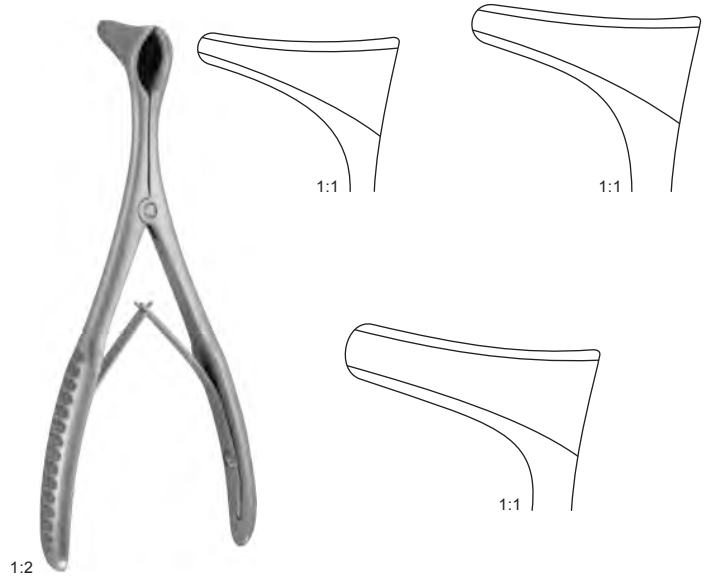

MOD. WIEN
VW-136
145 mm - 5 3/4"



VW-137 - 140
KILLIAN
130 mm - 5"

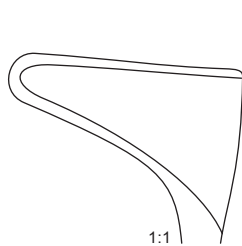

VW-137
X = 35 mm

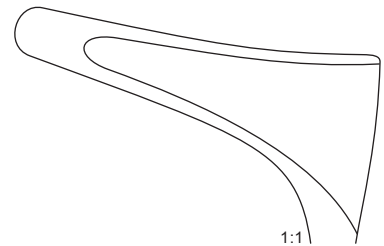

VW-138
X = 50 mm

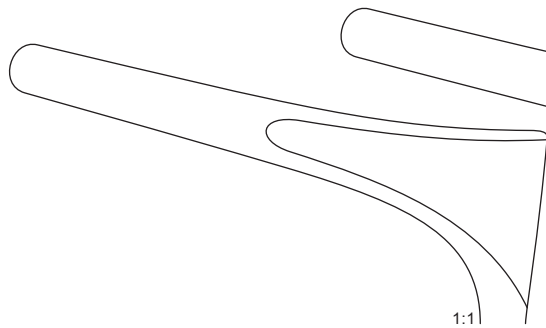

VW-139
X = 75 mm

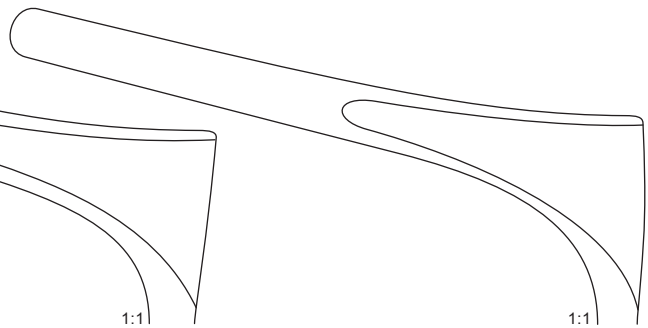

VW-140
X = 90 mm



WESTMACOTT
VW-141 **VW-141-1**
 200 mm - 8" 130 mm - 5"

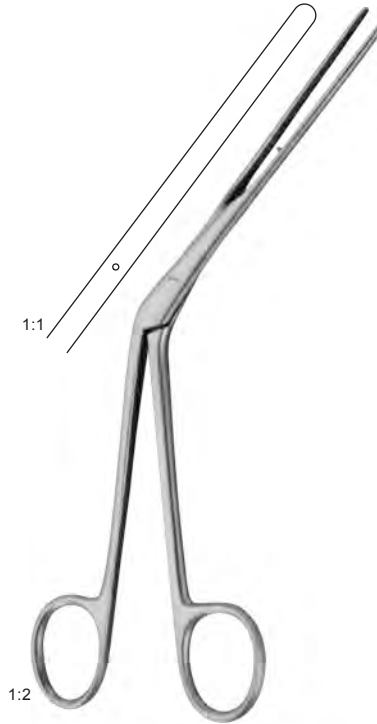

LUBET - BARBON
VW-142
 200 mm - 8"



HARTMANN HARTMANN
VW-143 **VW-143-1**
 160 mm - 6 1/4" 200 mm - 8"

NASAL DRESSING FORCEPS

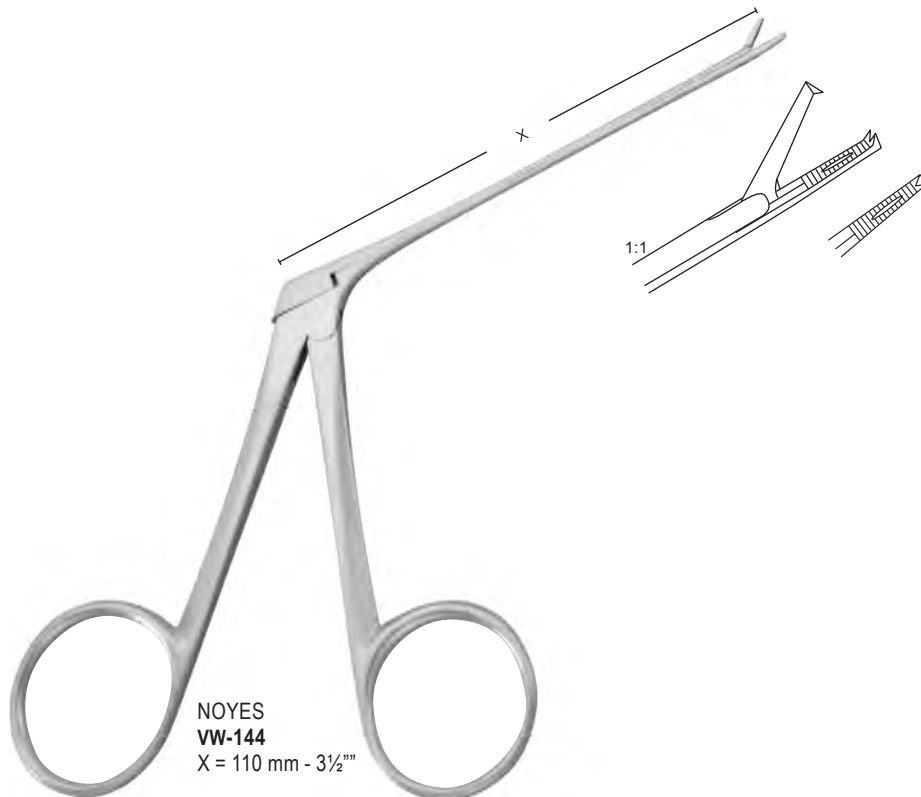

NOYES
VW-144
 X = 110 mm - 3 1/2"

NASAL CUTTING FORCEPS

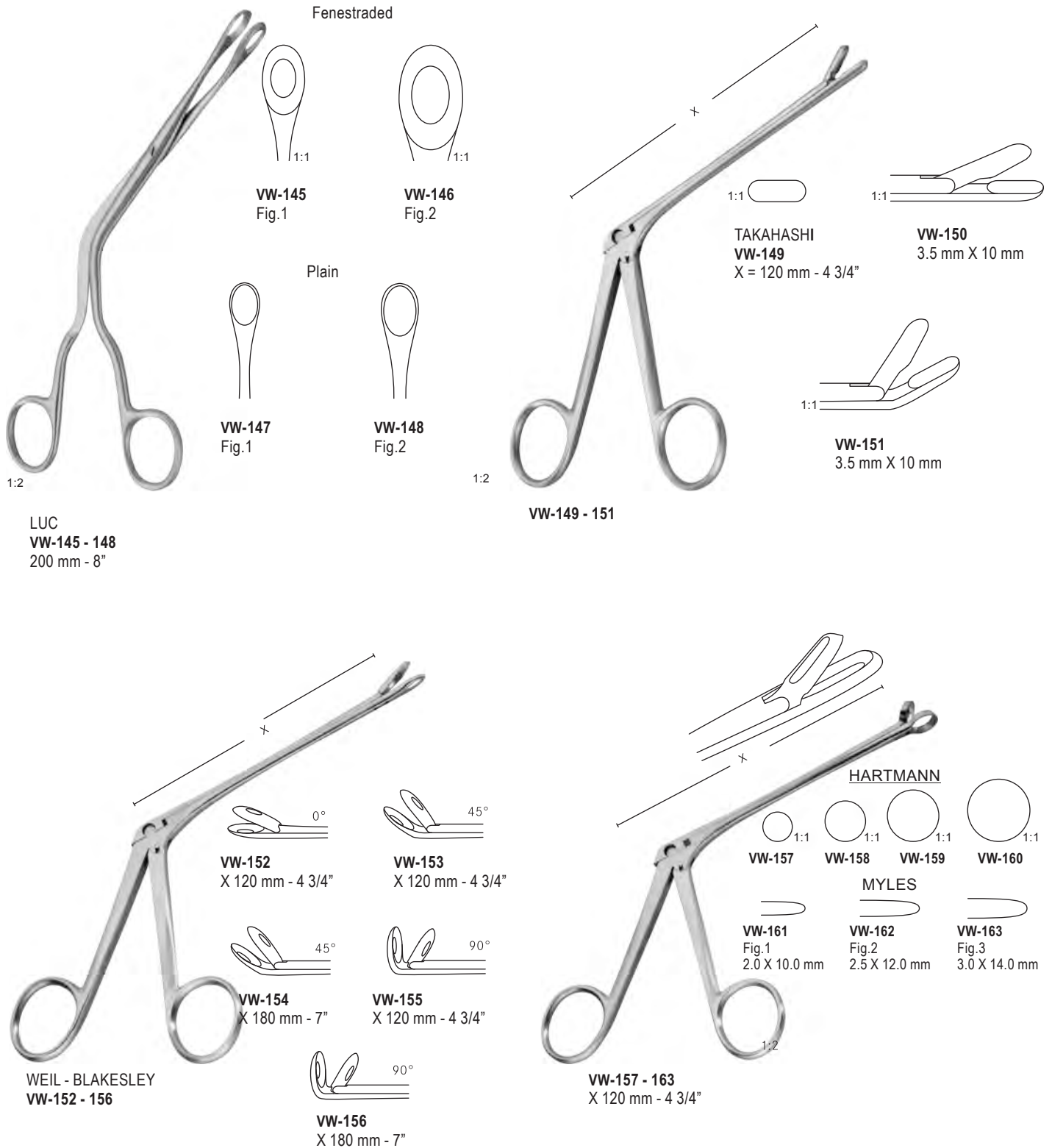

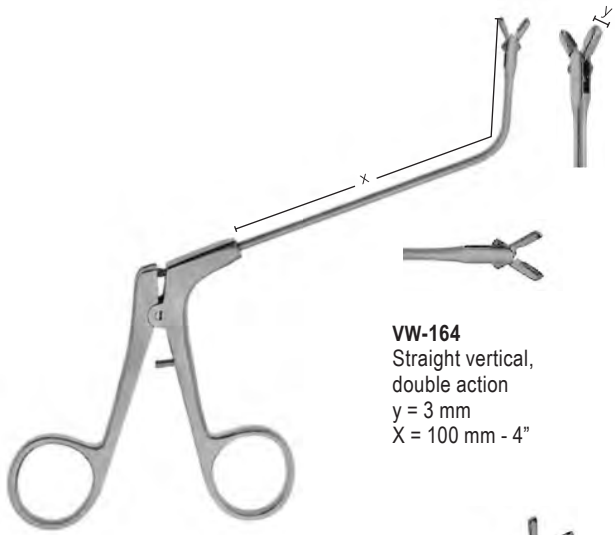

VW-164 - 170

VW-164
Straight vertical,
double action
y = 3 mm
X = 100 mm - 4"

VW-165
Straight, double action
y = 3 mm
X = 100 mm - 4"

VW-166
45° Vertical, double action
y = 3 mm
X = 100 mm - 4"

VW-167
45° double action
y = 3 mm
X = 100 mm - 4"



VW-168
70° vertical, double action
y = 3 mm
X = 100 mm - 4"



VW-169
70° double action
y = 3 mm
X = 100 mm - 4"



VW-170
110° double action
y = 3 mm
X = 100 mm - 4"

CIRCULAR FORCEPS AND ANTRUM PUNCH

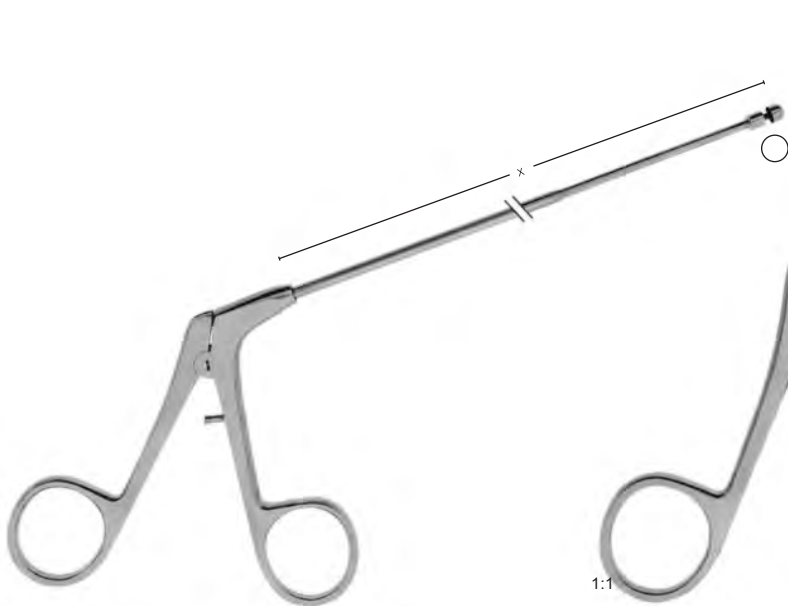

VW-171
Straight curved upwards
X = 180 mm - 7"
3.5 mm ø
4.5 mm ø

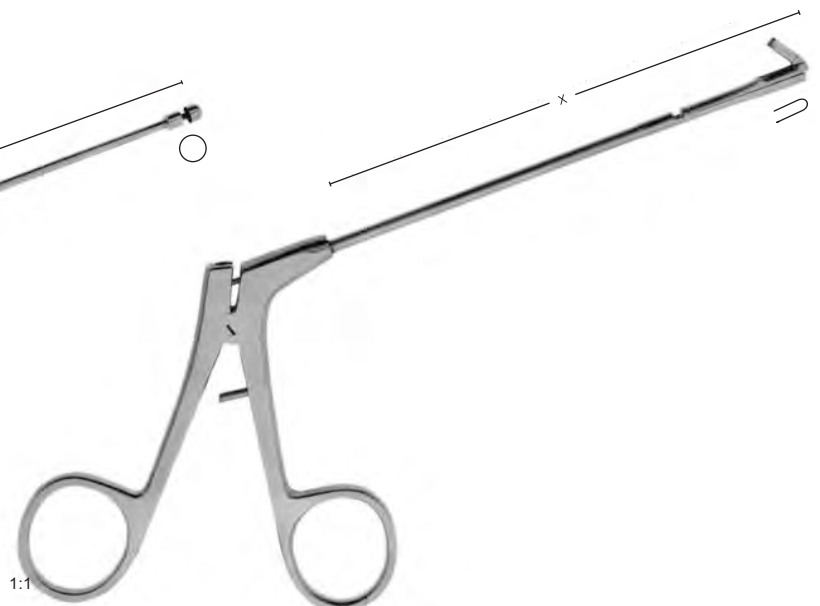

VW-172
X = 100 mm
1.5 mm X 4.5 mm
Fig.1 backward, up-cutting
Fig.2 backward, cut to the right
Fig.2 backward, cut to the left



TONSIL KNIVES



1:2
**FREER
VW-173**
210 mm - 8 1/4"



1:2
**FREER
VW-174**
210 mm - 8 1/4"



1:2
**SICKLE KNIFE
VW-175**
200 mm - 8"



1:2
**BRUNINGS
VW-176**
230 mm - 9"



1:2
**ABRAHAM
VW-177**
220 mm - 8 3/4"



1:2
**FISCHER
VW-178**
230 mm - 9"



1:2
**SHARP
VW-179**
200 mm - 8"



1:2
LEMPERT
VW-180
200 mm - 8"
X = 6 mm

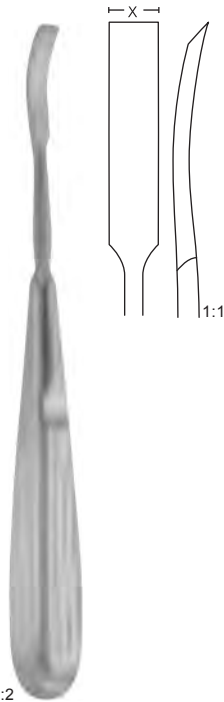

1:2
LEMPERT
VW-181
180 mm - 7"



1:2
FREER
VW-182
160 mm - 6 1/4"
X = 4 mm

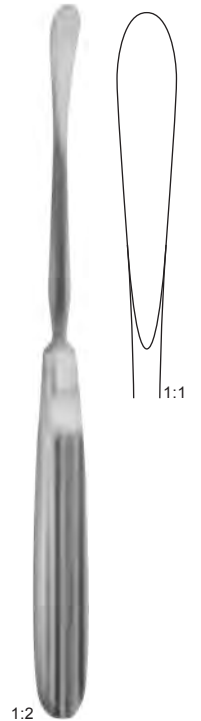

1:2
COTTLE
VW-183
sharp
190 mm - 7 1/2"
X = 8 mm

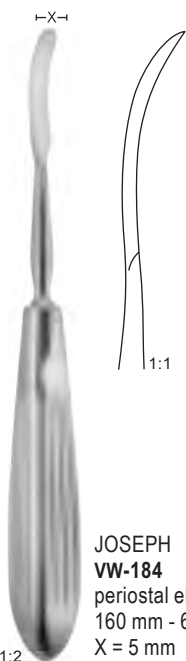

1:2
JOSEPH
VW-184
periosteal elevators
160 mm - 6 1/4"
X = 5 mm



1:2
SEWALL
VW-185
antrum elevators
200 mm - 8"



1:2
HALLE
VW-186
antrum elevators
160 mm - 6 1/4"



PERIOSTEAL ELEVATORS



MASING
VW-187
200 mm - 8"



BALLENGER - HAJEK
VW-188
190 mm - 7 1/4"
220 mm - 8 3/4"

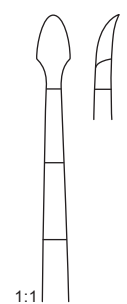

COTTLE
VW-189
220 mm - 8 3/4"

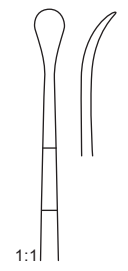

COTTLE
VW-190
210 mm - 8 1/4"

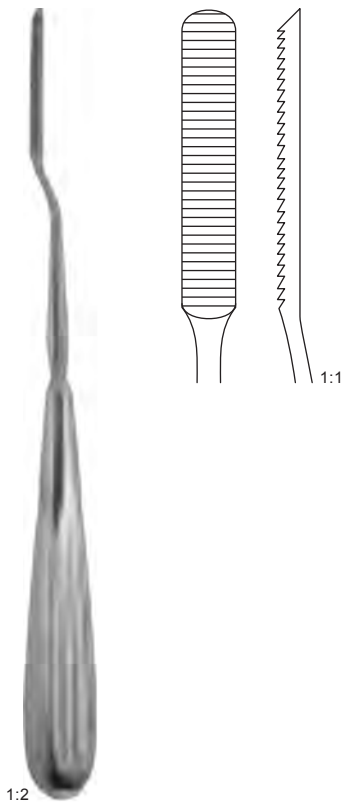

COTTLE
VW-191
 210 mm - 8 1/4"

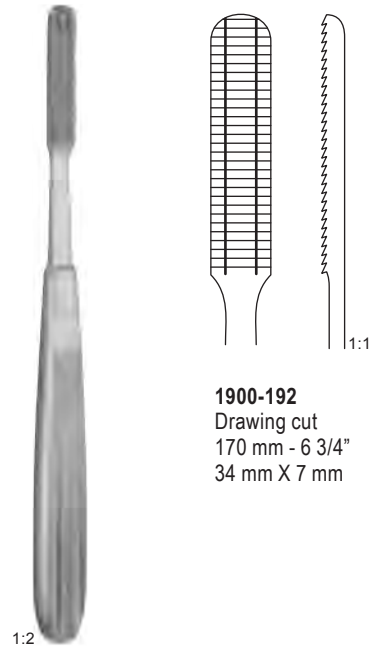

MALTZ
VW-192 - 193

1900-192
 Drawing cut
 170 mm - 6 3/4"
 34 mm X 7 mm

1900-193
 Pushing cut
 170 mm - 6 3/4"
 34 mm X 7 mm

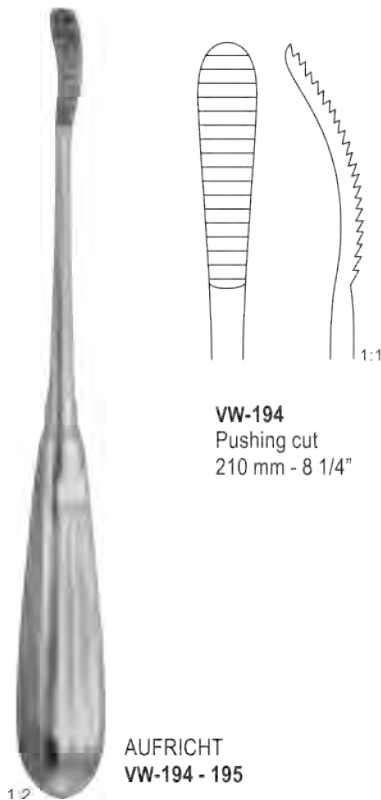

AUFRICHT
VW-194 - 195

VW-194
 Pushing cut
 210 mm - 8 1/4"

VW-195
 Drawing cut
 210 mm - 8 1/4"

RASPS WITHOUT TUNGSTEN CARBIDE



VW-196 - 205
200 mm - 8"

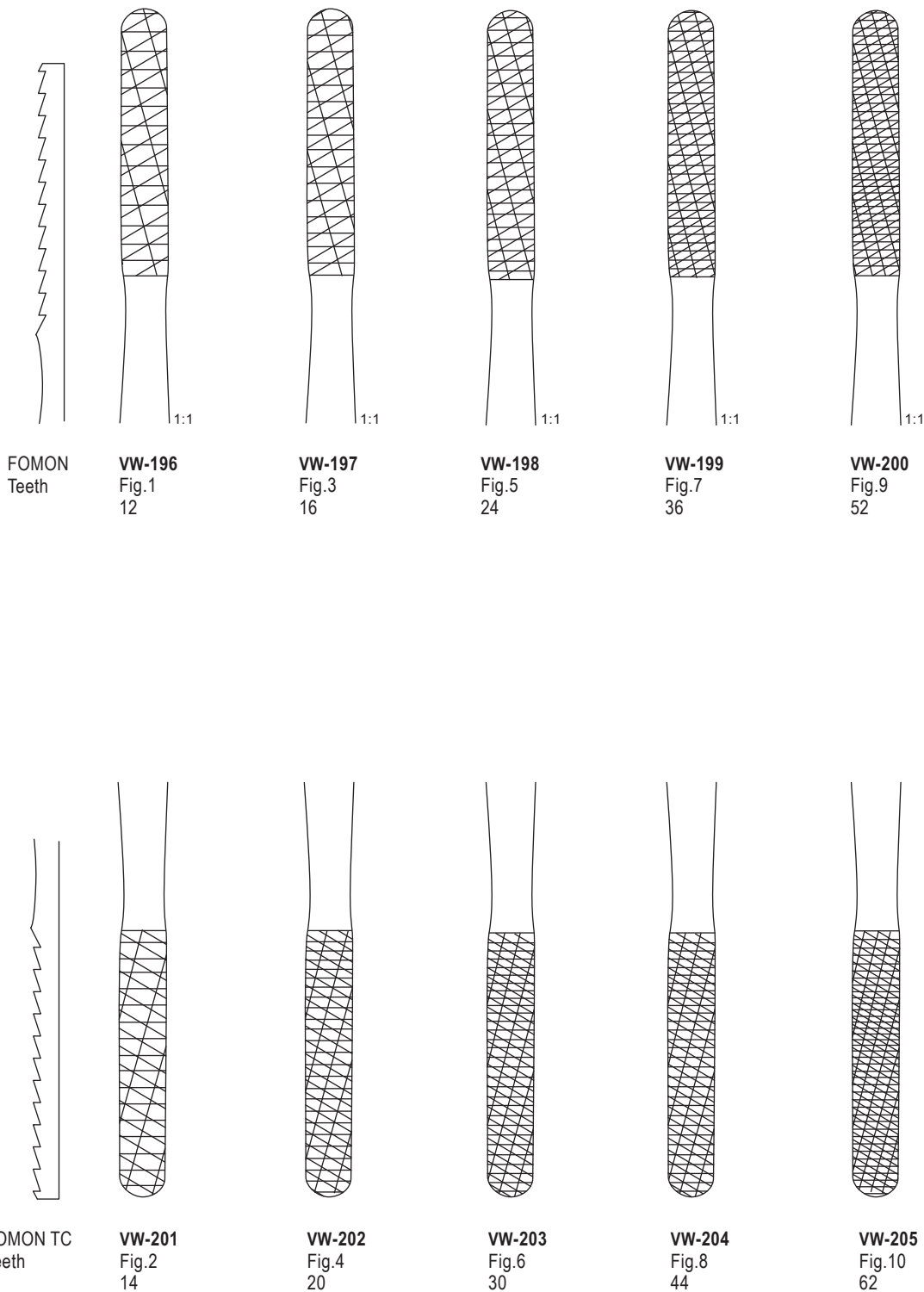



VW-206 - 208



VW-206
Straight



VW-207
Left

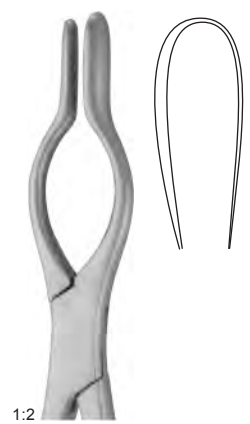

VW-208
Right

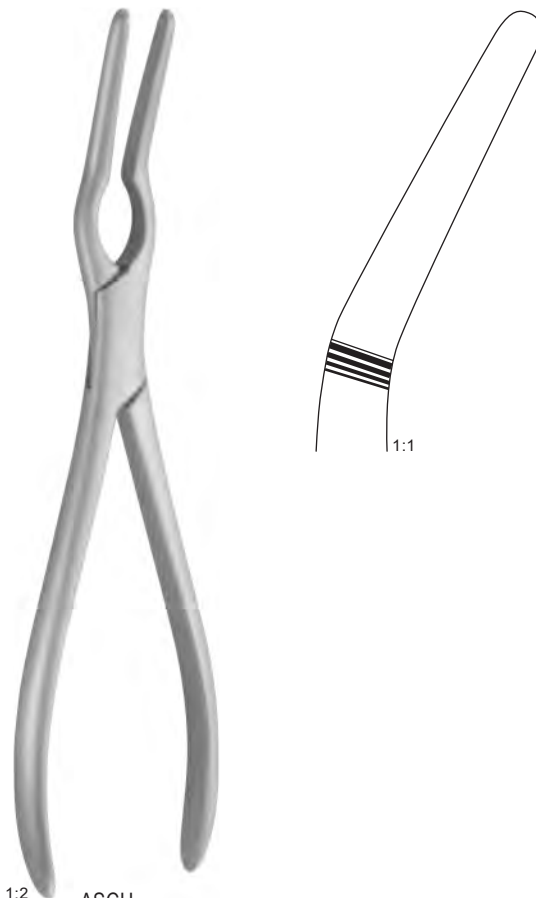

ASCH
VW-209
230 mm - 9"

SEPTUM FORCEPS AND SCISSOR



1:2 MIDDLETON - JANSEN
VW-210
190 mm - 7½"

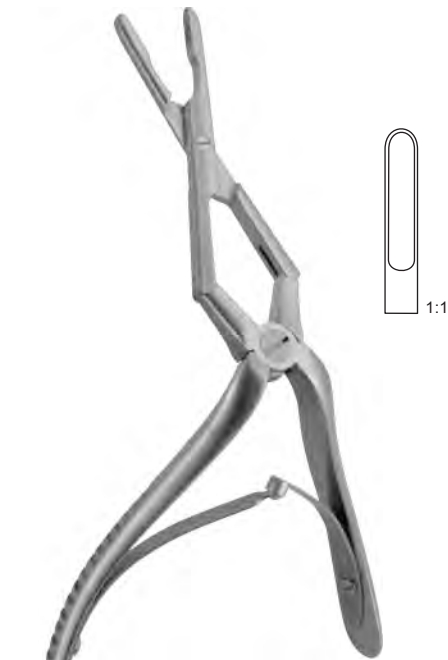

1:2 MIDDLETON - JANSEN
VW-211
190mm - 7½"

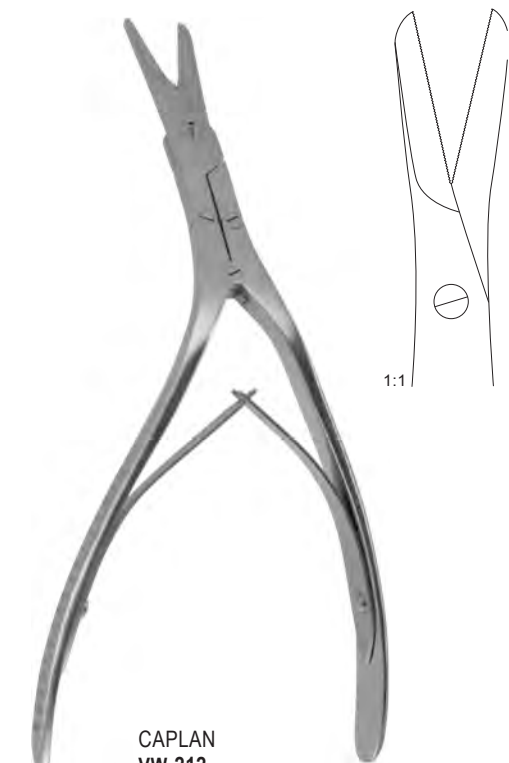

1:2 CAPLAN
VW-212
toothed
200 mm - 8"

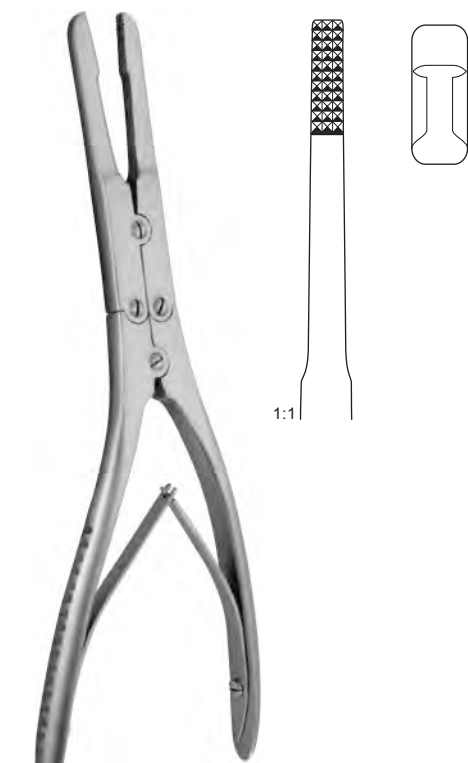

1:2 RUBIN
VW-213
protection cap
210 mm - 8 1/4"

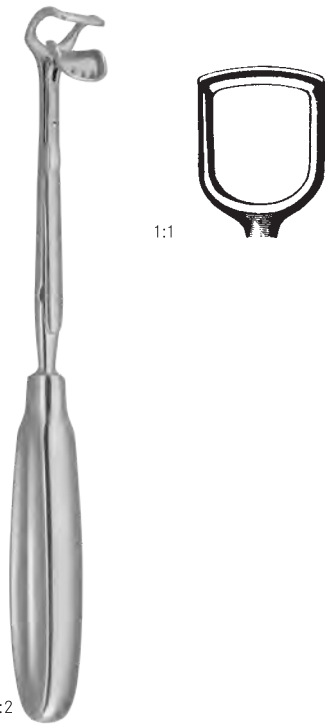

1:2
ST. CLAIR-THOMSON
VW-214
 210 mm - 8 1/4"

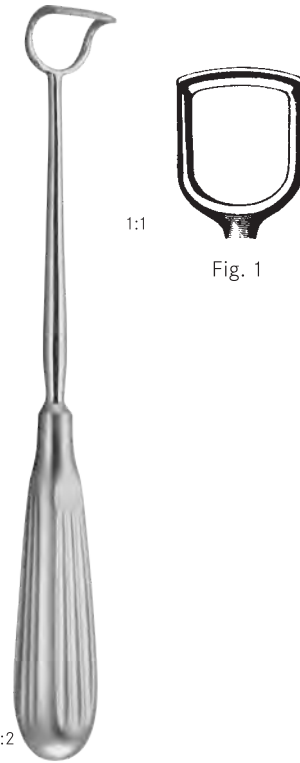

1:2
BARNHILL
VW-215
 220 mm - 8 3/4"



BECKMANN
VW-216
 Straight Curved
 220 mm - 8 3/4"

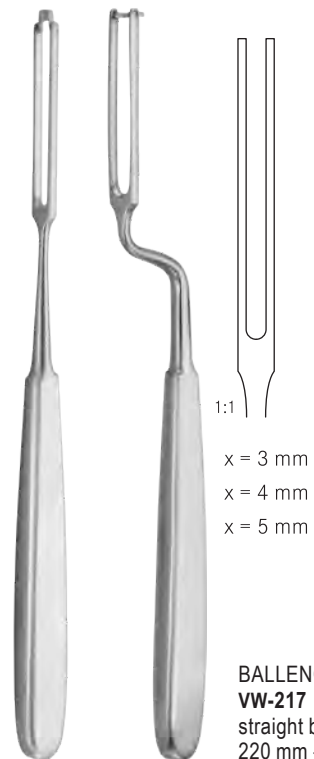

BALLENGER
VW-217
 straight bayonet
 220 mm - 8"



MOUTH GAGS



1:2

**MOLT
VW-218**
for children
110 mm - 4 1/4"



1:2

**MOLT
VW-219**
for adults
140 mm - 5 1/2"



1:2

**DENHART
VW-220**
120 mm - 4 3/4"



1:2

**FERGUSON - ACKLAND
VW-221**
145 mm - 5 3/4"



**ROSER - KÖNIG
VW-222**
160 mm - 6 1/4"
190 mm - 7 1/2"



VW-223 - 233

VW-223	Fig. 00	8 mm	∅
VW-224	Fig. 0	10 mm	∅
VW-225	Fig. 1	12 mm	∅
VW-226	Fig. 2	14 mm	∅
VW-227	Fig. 3	16 mm	∅
VW-228	Fig. 4	18 mm	∅
VW-229	Fig. 5	20 mm	∅
VW-230	Fig. 6	22 mm	∅
VW-231	Fig. 7	24 mm	∅
VW-232	Fig. 8	26 mm	∅
VW-233	Fig. 9	28 mm	∅
VW-233	Fig. 10	30 mm	∅



1:2
VW-234
100 mm - 4"



VW-235 - 246

VW-235	Fig. 00	8 mm	∅
VW-236	Fig. 0	10 mm	∅
VW-237	Fig. 1	12 mm	∅
VW-238	Fig. 2	14 mm	∅
VW-239	Fig. 3	16 mm	∅
VW-240	Fig. 4	18 mm	∅
VW-241	Fig. 5	20 mm	∅
VW-242	Fig. 6	22 mm	∅
VW-243	Fig. 7	24 mm	∅
VW-244	Fig. 8	26 mm	∅
VW-245	Fig. 9	28 mm	∅
VW-246	Fig. 10	30 mm	∅



MICHEL
VW-247 - 251
moveable mirror
250 mm - 9 3/4"

VW-247	10 mm	∅
VW-248	12 mm	∅
VW-249	14 mm	∅
VW-250	16 mm	∅
VW-251	18 mm	∅



TONSIL SNARES



EVES
VW-252
280 mm - 11"



EVES
VW-253
280 mm - 11"



BRUENINGS
VW-254
280 mm - 11"



VW-255
10 mm - 3/32"
0.3 mm Ø
0.4 mm Ø

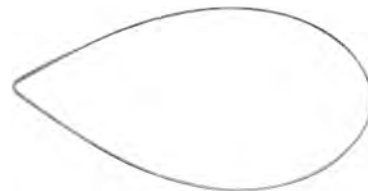

VW-256
Package of 100 pieces
40 mm
50 mm



1:2
COLVER
VW-257
 straight curved
 190 mm - 7½"



1:2
WHITE
VW-258
 180 mm - 7"
 230 mm - 9"

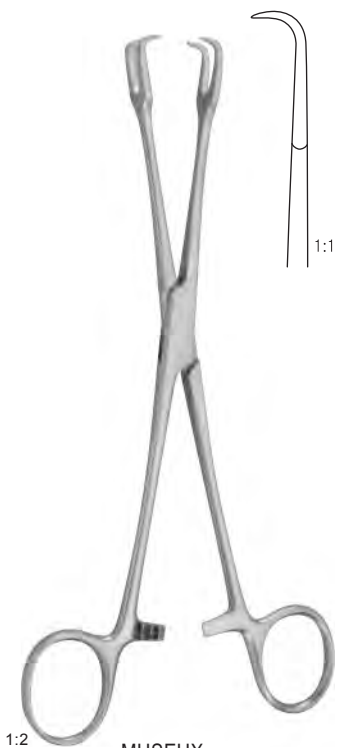

1:2
MUSEUX
VW-259
 tonsil holding forceps
 200 mm - 8"



1:2
JACKSON
VW-260
 laryngeal forceps
 220 mm - 8½"

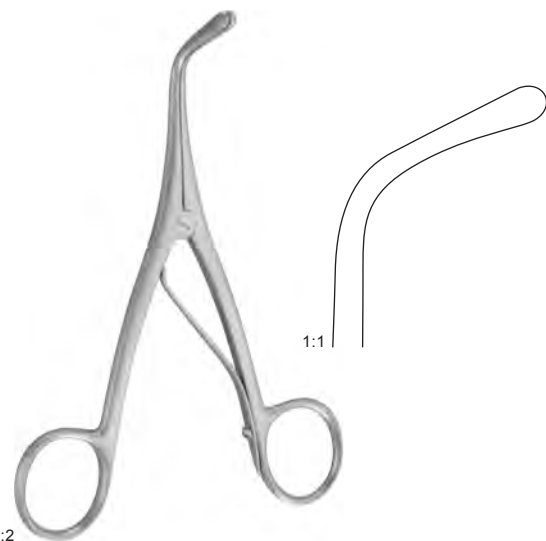

1:2
TROUSSEAU
VW-261
 140 mm - 5½"

TRACHEA DILATOR



BRONCHO - OESOPHAGOSCOPY FORCEPS

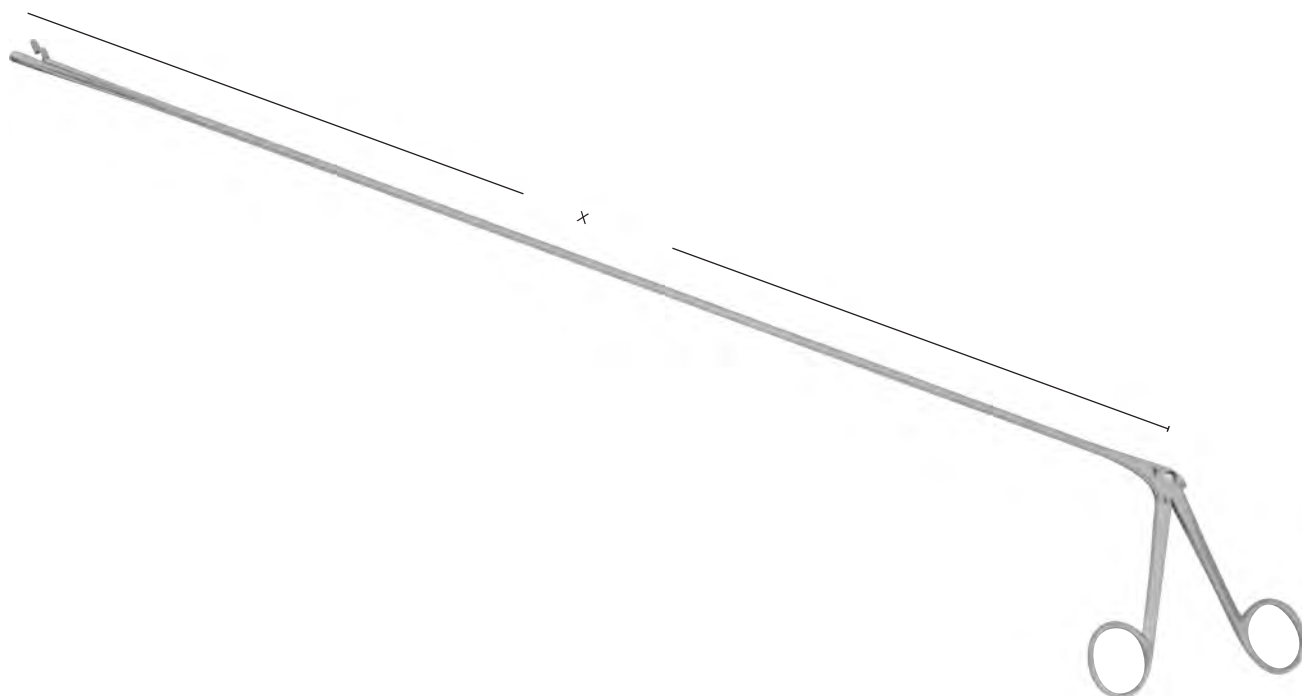

CHEVALIER - JACKSON
VW-262 - 268
X = 300 mm - 12"
X = 400 mm - 16"
X = 500 mm - 20"
X = 600 mm - 23½"



VW-262



VW-263



VW-264



VW-265



VW-266



VW-267



VW-268

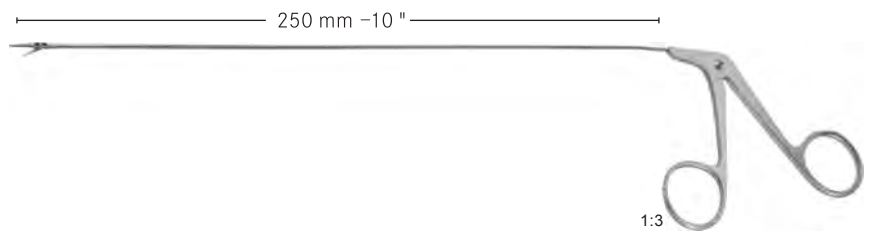

VW-269 - 285

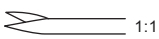

VW-269
Straight



VW-270
Straight horizontal



VW-271
Angled up horizontal

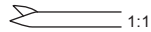

VW-272
Curved right

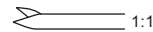

VW-273
Curved left

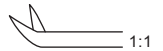

VW-274
Angled up



VW-275
Straight, serrated



VW-276
Straight horizontal



VW-277
Angled up horizontal



VW-278
Curved right



VW-279
Curved left



VW-280
Straight



VW-281
Angled up
02.5 mm



VW-282
Angled up horizontal



VW-283
Curved right



VW-284
Curved left

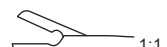

VW-285
Oval
03.5 mm



MOUTH GAGS



1/2

DAVIS-BOYLE
VW-286 - 288
complete, consisting of frame
and 5 tongue depressors no. 1-5

VW-286
Frame for Mouth Gag

VW-287
14.5 cm
Frame for Mouth Gag with joint

VW-288
14.5 cm
Silicone inlay



1/2

Fig. 1
VW-289 - 292
110 X 28 mm



Fig. 2
VW-289
95 X 27 mm



Fig. 3
VW-290
80 X 27 mm



Fig. 4
VW-291
65 X 26 mm



Fig. 5
VW-292
without suction tube
30 X 20 mm



NEUKAM
VW-293 - 297
complete, with frame
and 3 tongue depressors

NEUKAM
VW-293
Frame for Mouth Gag, only



VW-294
Tongue Depressor
fenestrated blade for suction

Fig. 1
VW-295

Fig. 2
VW-296

Fig. 3
VW-297



KILNER-DOUGHTY
VW-298 - 304
complete, with frame, 3 tongue depressors,
2 toothplates and 1 palate plate



VW-299
Palate plate

KILNER-DOUGHTY
VW-300
14.5 cm
Frame for Mouth Gag

KILNER-DOUGHTY
VW-301
Tongue Depressor
fenestrated blade for suction



Fig. 1
VW-302
68 X 30 mm

Fig. 2
VW-303
77 X 34 mm

Fig. 3
VW-304
82 X 39 mm



MOUTH GAGS

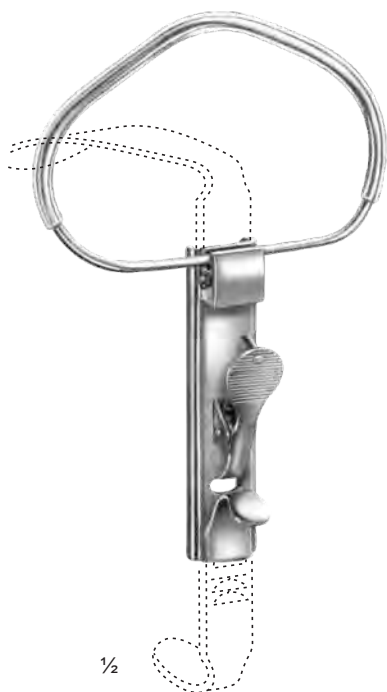

1/2

MCLVOR
VW-305 - 309
complete, with 3 tongue depressors



MCLVOR
VW-306
Tongue Depressors

1/2

Fig. 1
VW-307
100 X 25 mm

Fig. 2
VW-308
85 X 25 mm

Fig. 3
VW-309
75 X 25 mm

MCLVOR
VW-305
Frame for Mouth Gag

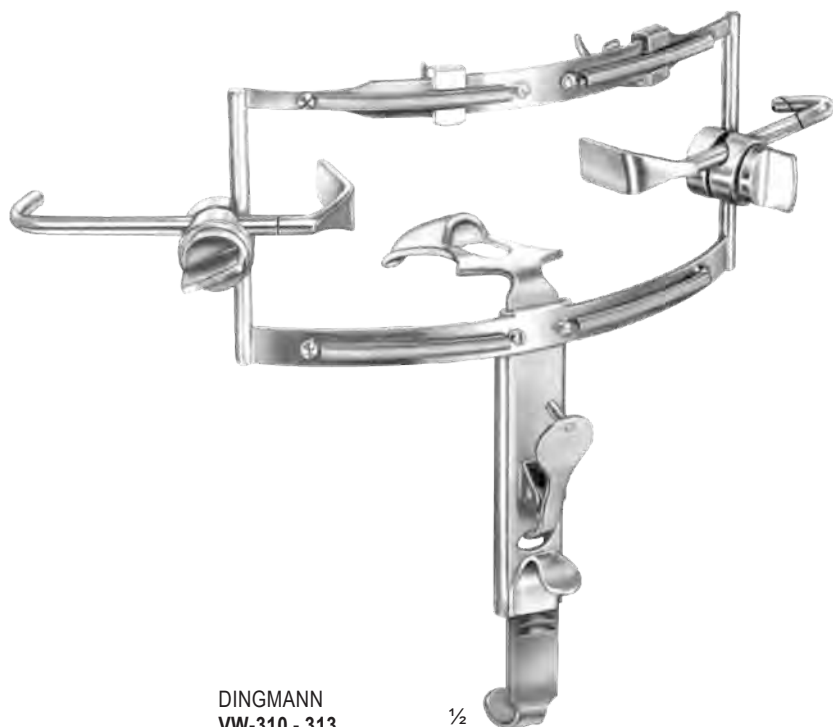

1/2

DINGMANN
VW-310 - 313
complete, with frame, 3 tongue depressors,
and 2 adjustable lateral blades

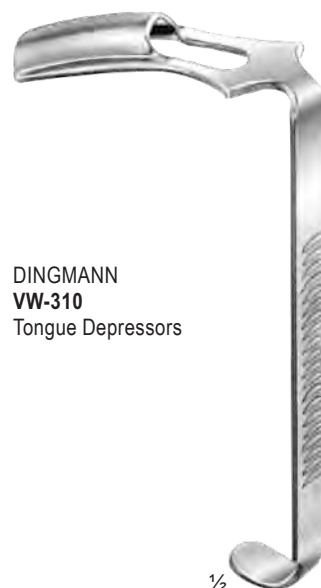

DINGMANN
VW-310
Tongue Depressors

1/2

Fig. 1
VW-311
62 X 26 mm

Fig. 2
VW-312
65 X 30 mm

Fig. 3
VW-313
78 X 32 mm



VW-314
Fig.1
20 mm X 70 mm



VW-315
Fig.2
30 mm X 80 mm



VW-316
Fig.3
33 mm X 95 mm



VW-317
Handle

NEGUS
VW-314 - 317
complete
handle

TONSIL INSTRUMENTS

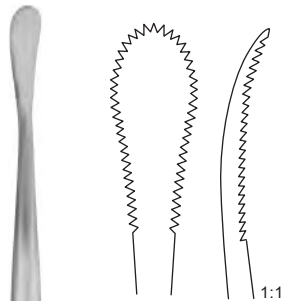

HENKE
VW-318
tonsil dissector
230 mm - 9"

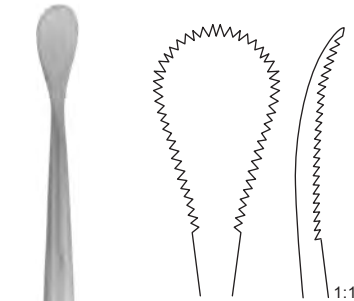

HENKE
VW-319
tonsil dissector
230 mm - 9"

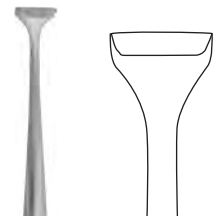

HURD
VW-320
tonsil dissector
225 mm - 8 3/4"



MOUTH GAGS, LIP AND CHEEK RETRACTORS



JENNINGS
VW-321 - 324
VW-321 10.5 cm
VW-322 12.5 cm
VW-323 14.5 cm
VW-324 16.5 cm

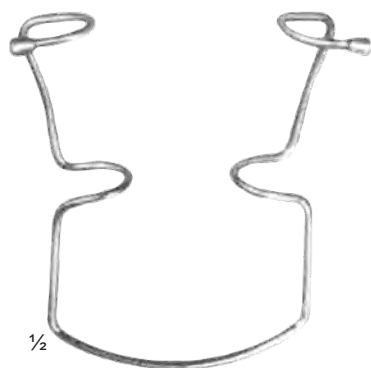

ORINGER
VW-325 - 327
9.5 cm
self retaining, for children

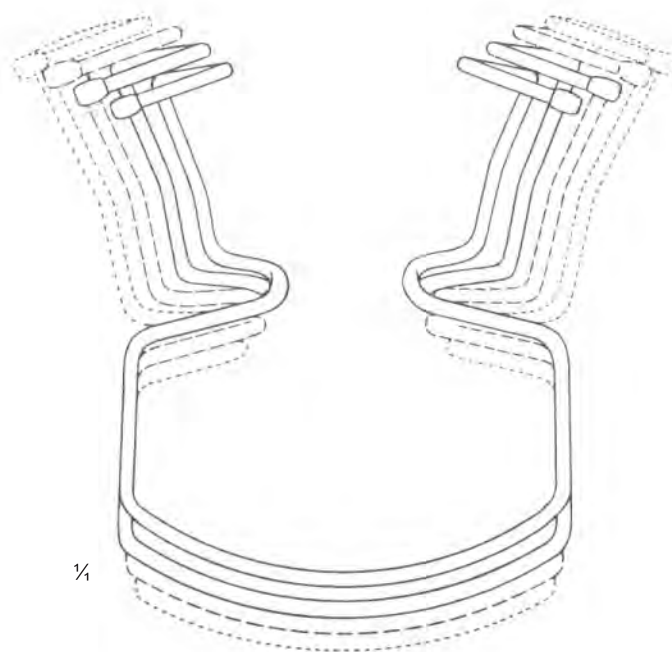
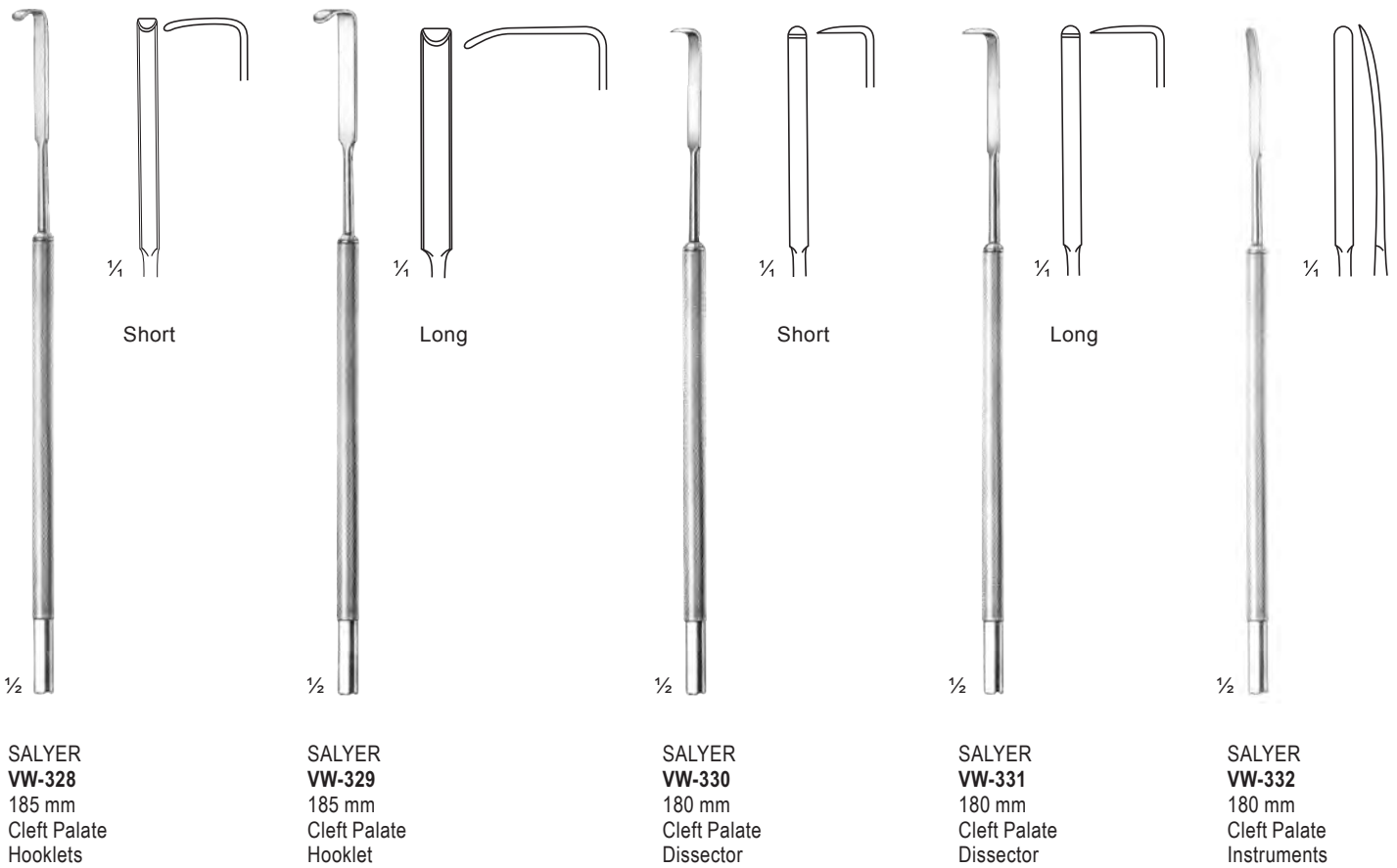

Fig. 1
VW-325
10 cm

Fig. 2
VW-326
10.5 cm

Fig. 3
VW-327
11 cm



EXCHANGEABLE TIPS



FRAENKEL
VW-333
for interchangeable tubes

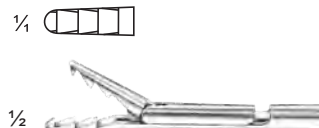

SEIFFERT
VW-334
for interchangeable tubes

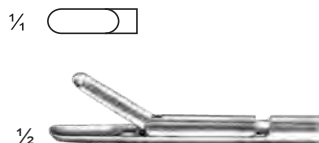

FRAENKEL
VW-335
for interchangeable tubes

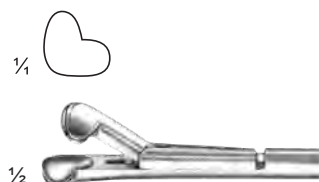

SCHEINMANN
VW-336
for interchangeable tubes

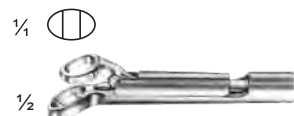

SCHEINMANN
VW-337
for interchangeable tubes



BRÜNINGS
VW-338 - 339
for interchangeable tubes



Fig. 2
VW-338



Fig. 3
VW-339



Fig. 2
VW-340



Fig. 3
VW-341



BRÜNINGS
VW-340 - 341
for interchangeable tubes



LANGE
VW-342
for interchangeable tubes



Fig. 1
VW-342



Fig. 1
VW-343



Fig. 2
VW-344



KRAUSE
VW-343 - VW-344
for interchangeable tubes



KRAUSE
VW-345
for interchangeable tubes



Fig. 1
VW-346



Fig. 2
VW-347



Fig. 3
VW-348



Fig. 4
VW-349



CORDES
VW-346 - 349
for interchangeable tubes



SCHUMACHER
VW-350
for interchangeable tubes



Fig. 1
VW-351



Fig. 2
VW-352



CORDES
VW-351 - VW-352
for interchangeable tubes



CORDES
VW-353
for interchangeable tubes



ROSENBERG
VW-354
for interchangeable tubes



MICRO EAR FORCEPS

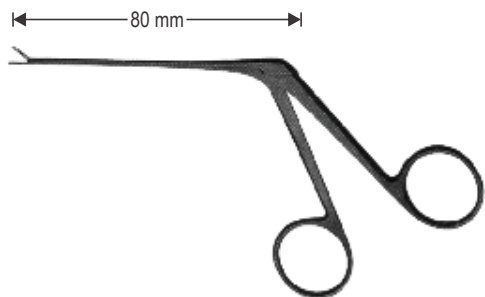

VW-355 - 359

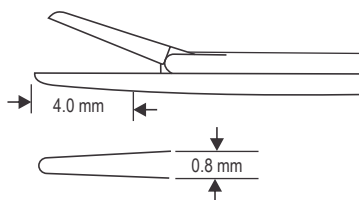

VW-355
4.0 x 0.8 mm
Smooth, straight

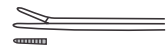
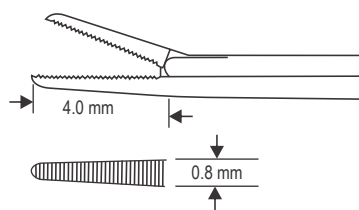

VW-356
4.0 x 0.8 mm
Serrated, straight



VW-357
4.0 x 0.8 mm
Sent upwards, serrated



VW-358
4.0 x 0.8 mm
Right, serrated

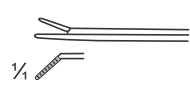

VW-359
4.0 x 0.8 mm
Left, serrated

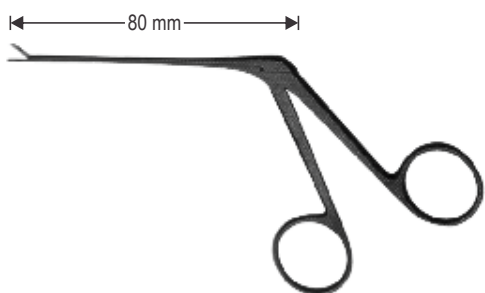

Mini-McGee
VW-360 - 361

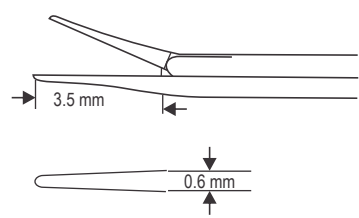

VW-360
3.5 x 0.6 mm
Smooth, straight

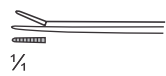
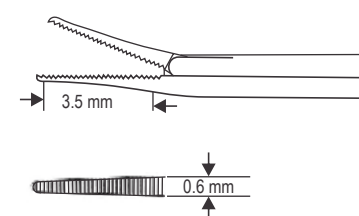

VW-361
3.5 x 0.6 mm
Serrated, straight

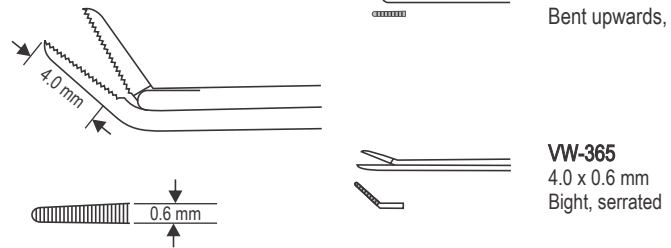
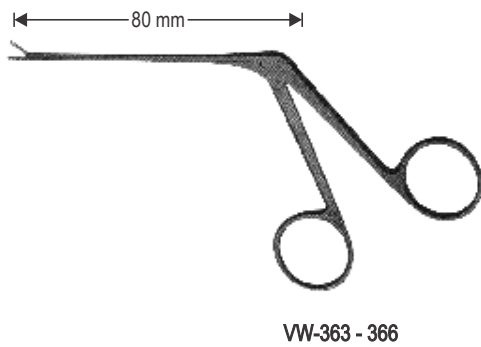
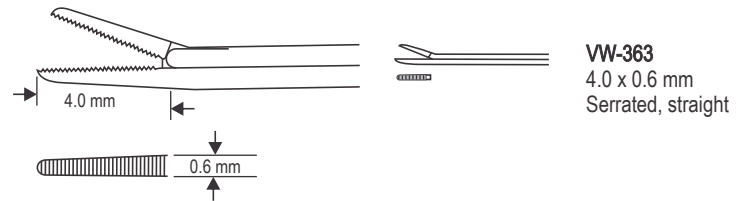
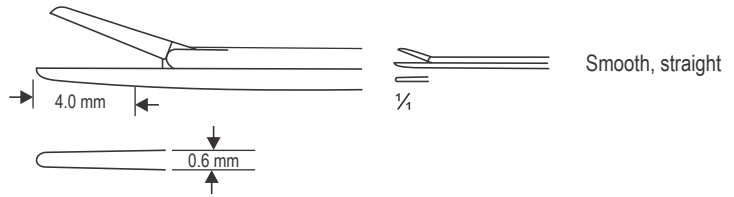
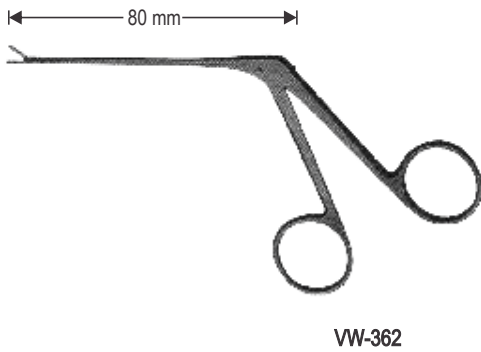



TUNING FORKS

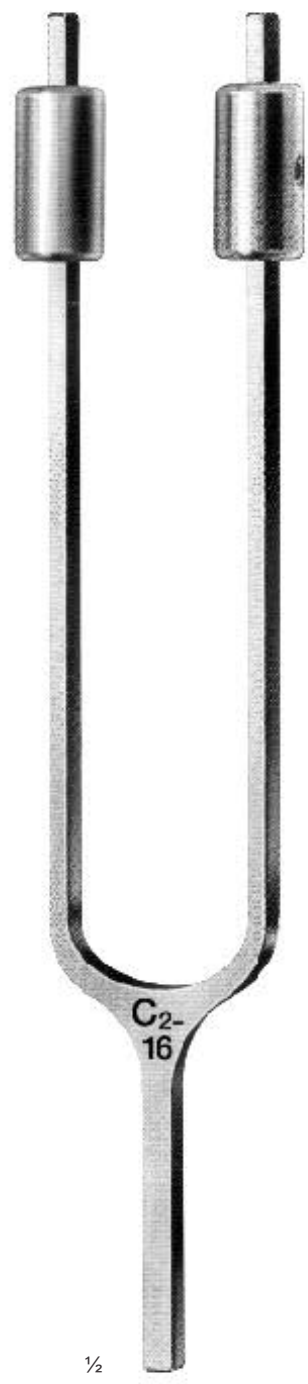

French
VW-367
C:16



French
VW-368
C:32

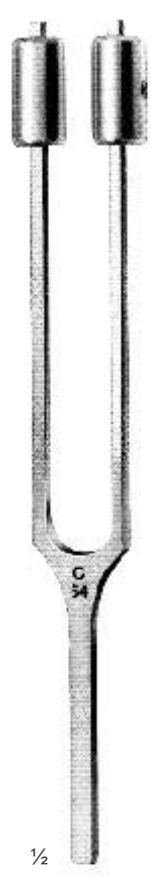

Hartmann
VW-369
C 64

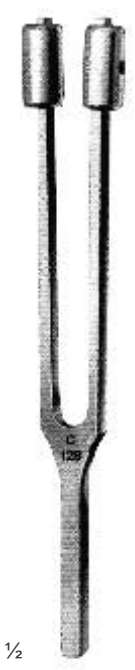

Hartmann
VW-370
C 128



Hartmann
VW-371
C 256



Hartmann
VW-372
C 128

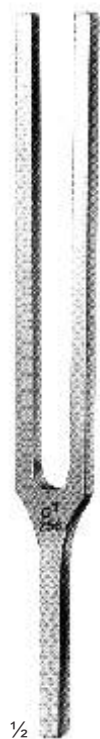

Hartmann
VW-373
C' 256



Hartmann
VW-374
C² 512



Hartmann
VW-375
C³ 1024



Hartmann
VW-376
C⁴ 2048



Hartmann
VW-377
C⁵ 4096

KNIVES, SEPTUM KNIVES

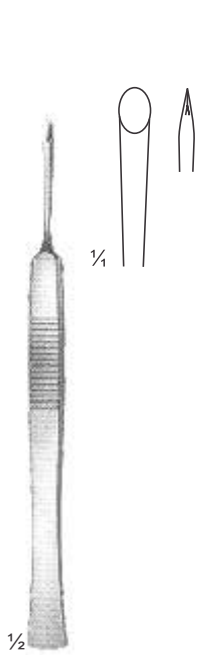

Cottle
VW-378
14 cm
Rhinoplastic knife

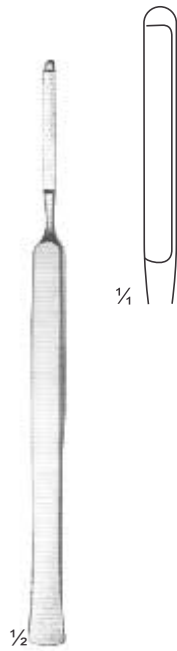

Joseph
VW-379
15.5 cm
Rhinoplastic knife

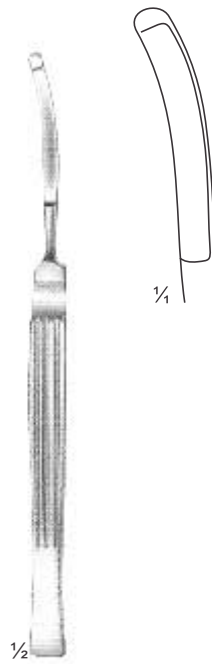

Converse
VW-380
16 cm
Rhinoplastic knife

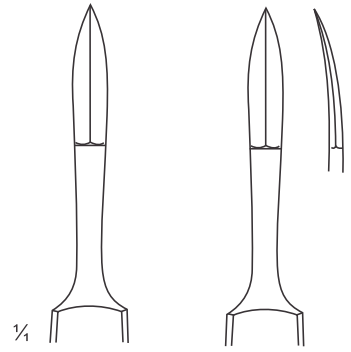
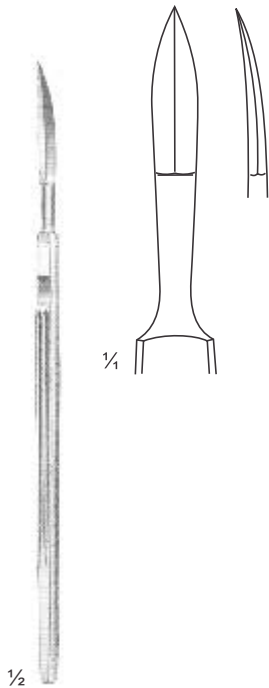

Fig. 1
VW-381

Fig. 2
VW-382



Joseph
VW-381 - 382
15 cm
Rhinoplastic knife



Fomon
VW-383
16.5 cm
Rhinoplastic knife



Freer
VW-384
16.5 cm
Mucosa knife
Septum knife



Freer
VW-385
19 cm
Septum knife



Freer
VW-386
18.5 cm
Septum knife



Freer
VW-387
16 cm
Septum chisel



Freer
VW-388
16.5 cm
Septum chisel

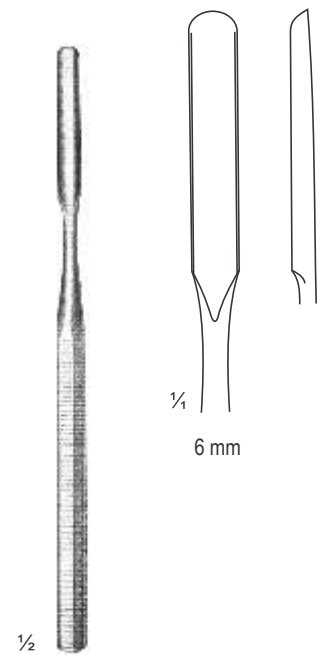

Freer
VW-389
16 cm
Septum gouge

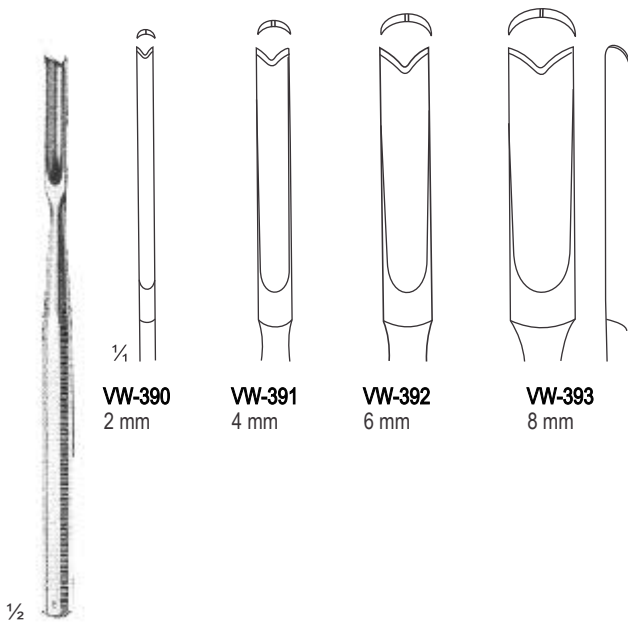

Ballenger
VW-390 - 393
15 cm
Septum gouge

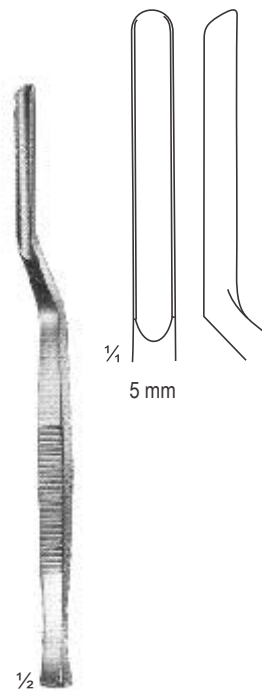

Killian
VW-394
16 cm
Septum gouge

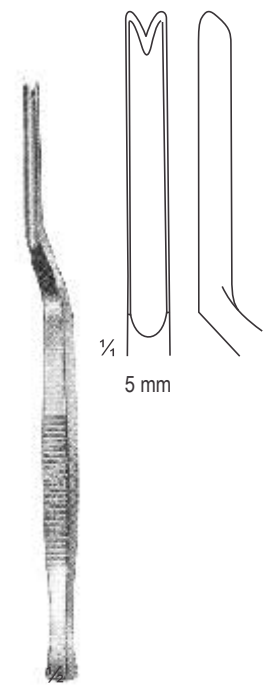

Killian-Claus
VW-395
16 cm
Septum gouge



OSTEOTOMES, CHISELS

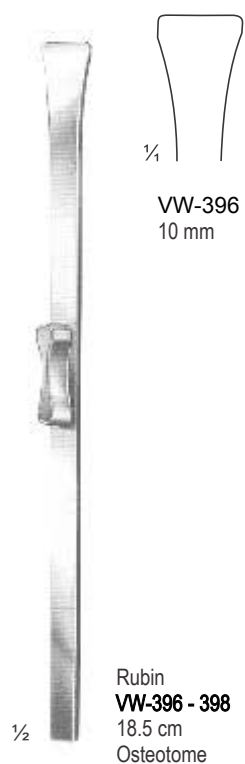

VW-396
10 mm



VW-397
12 mm

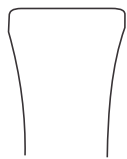

VW-398
14 mm

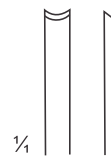
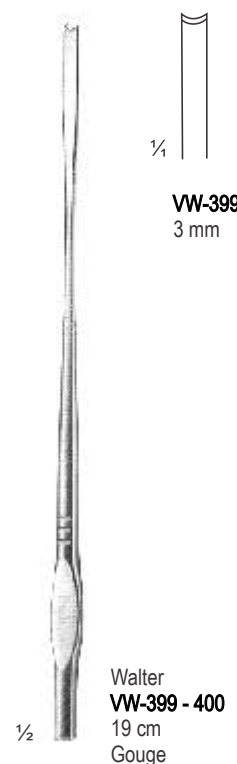

VW-399
3 mm

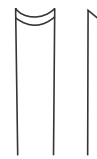

VW-400
4.5 mm

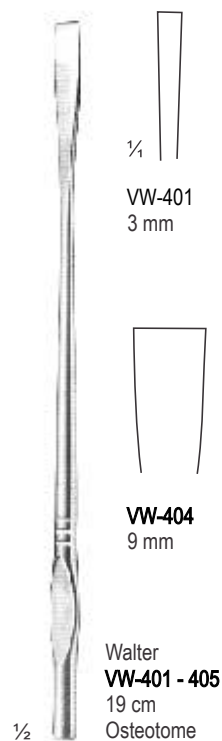

VW-401
3 mm



VW-402
4 mm



VW-403
7 mm



VW-404
9 mm

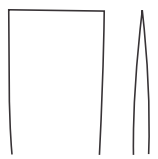

VW-405
12 mm

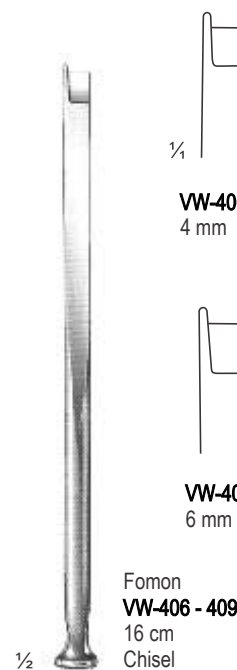

VW-406
4 mm

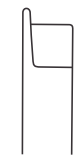

VW-407
4 mm

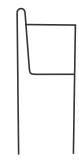

VW-408
6 mm



VW-409
7 mm

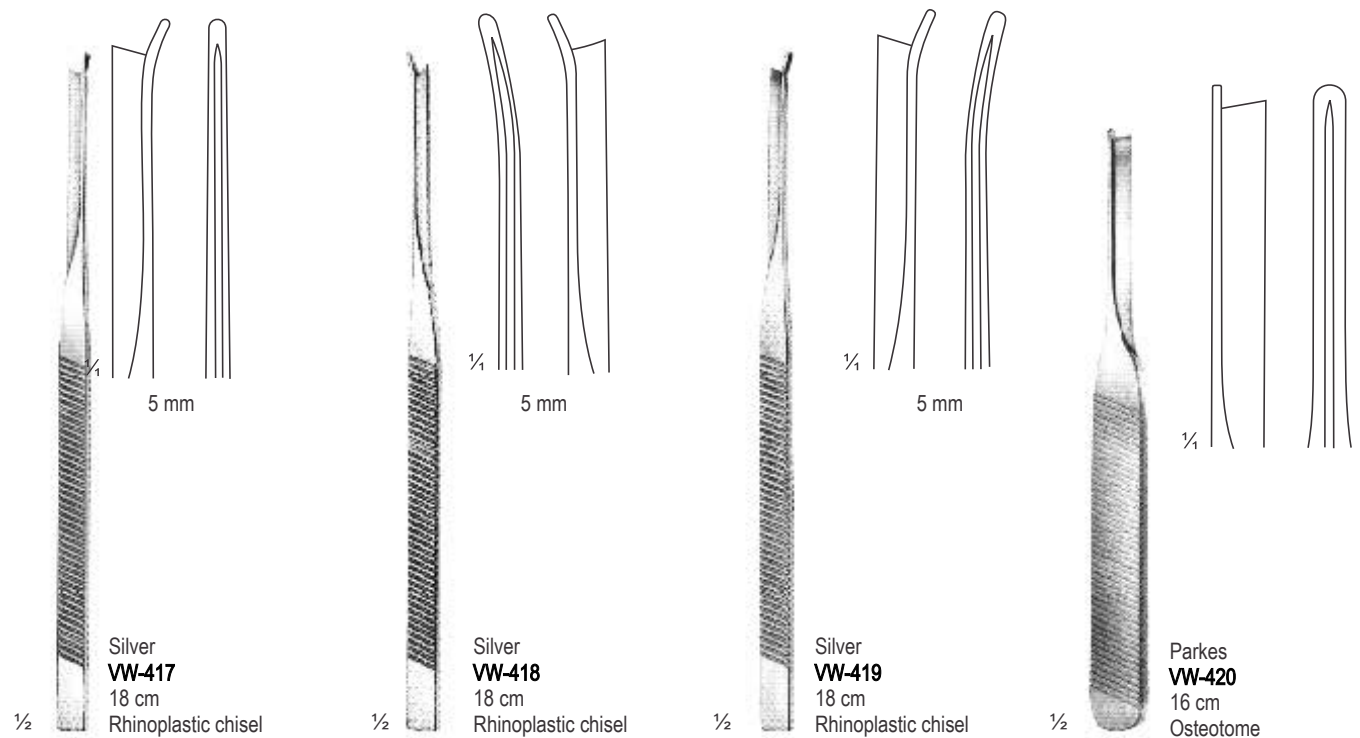
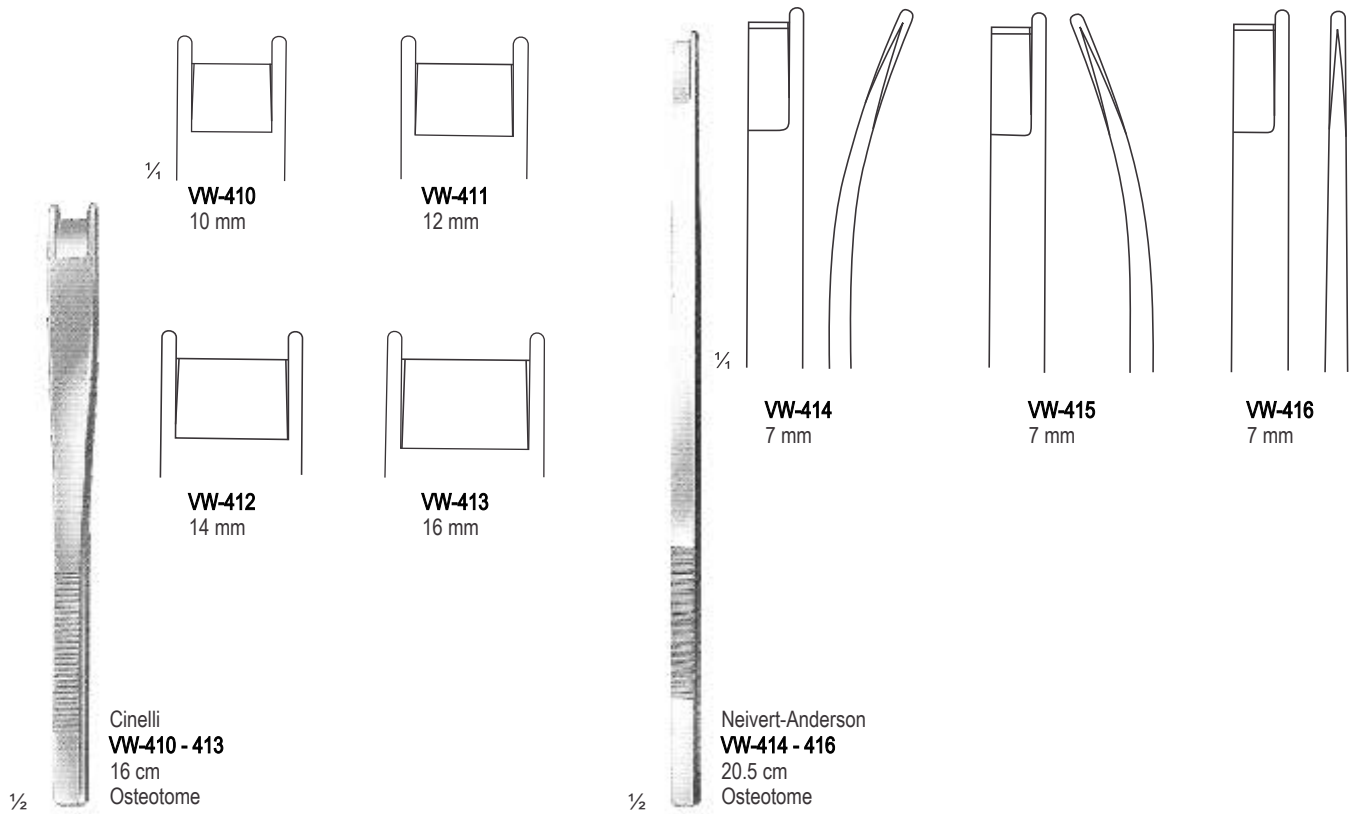

NASAL SAWS, CARTILAGE CRUSHER

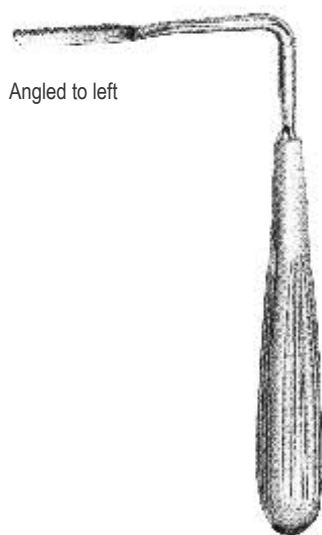

Angled to left

Joseph
VW-421
17 cm
Nasal saw

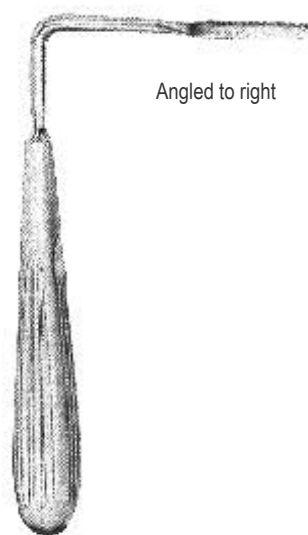

Angled to right

Joseph
VW-422
17 cm
Nasal saw



1/2

Joseph
VW-423 - 425
19 cm
Nasal saw



1/4

VW-423
Working length
40 mm

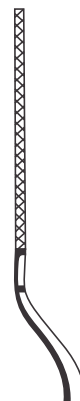

VW-424
Working length
40 mm



VW-425
Working length
40 mm

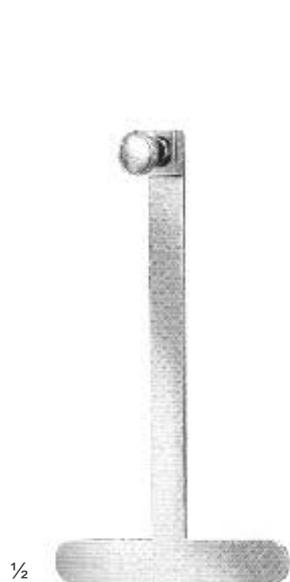

1/2

Cottle
VW-426
12 cm
Handle cartilage crusher



Cottle
VW-427
Guide support for osteotomes
7 mm wide
Cartilage crusher



Cottle
VW-428
Cartilage crusher
65 x 30 x 30 mm
Cartilage crusher

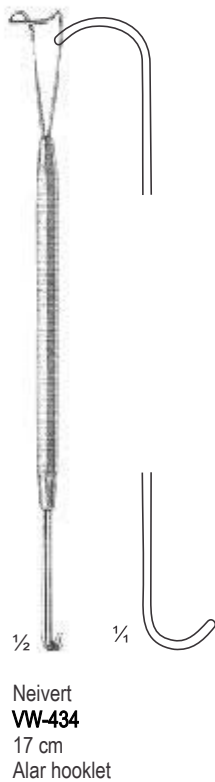
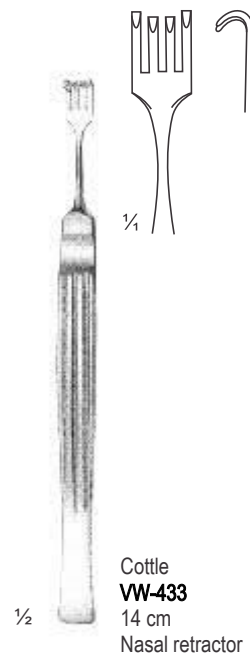
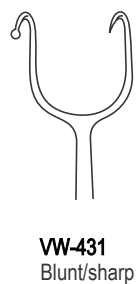
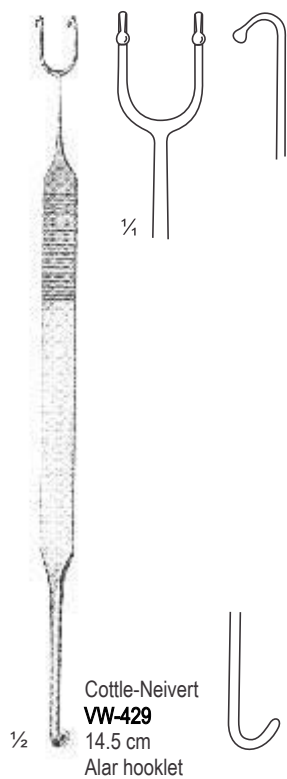

SKIN GRASPING FORCEPS, ANTRUM CURETTES

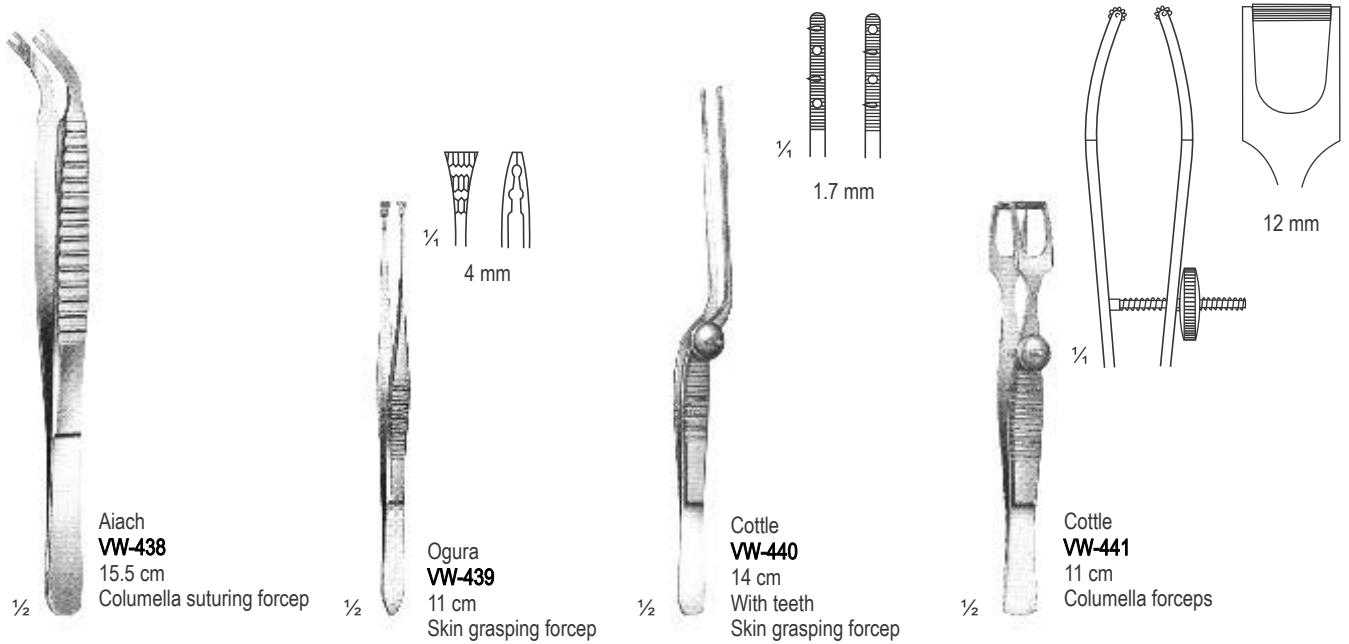



Eicken-Killian
VW-449
14cm
Antrum irrigation
Cannula



Eicken-Killian
VW-450
14 cm
Antrum irrigation
cannula

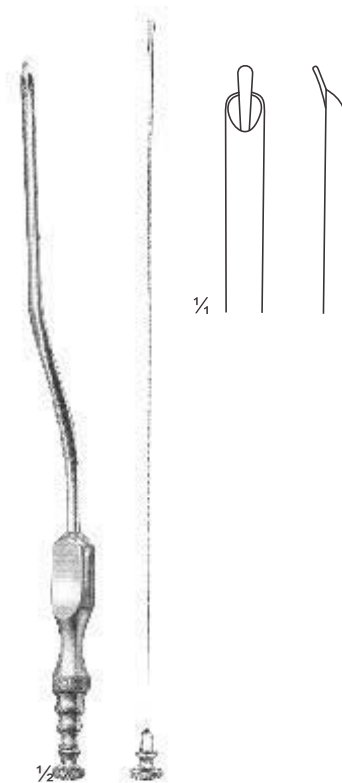

Guilen
VW-451
19 cm
Suction rasparatory



Ritter-Halle
VW-452 - 454 14.5
cm
Frontal sinus dilator

○
VW-452
Ø 3.0 mm
2.5 mm

○
VW-453
Ø 3.0 mm

○
VW-454
Ø 4.0 mm

NASAL SPECULA

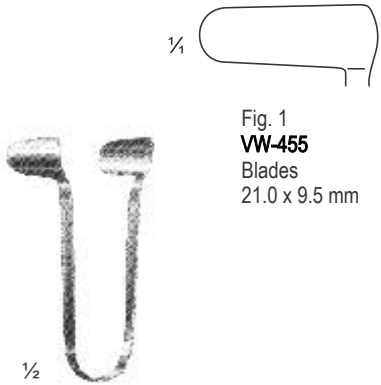

Fig. 1
VW-455
Blades
21.0 x 9.5 mm

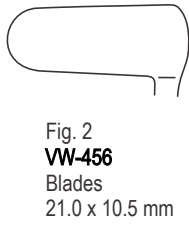

Fig. 2
VW-456
Blades
21.0 x 10.5 mm

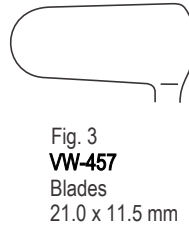
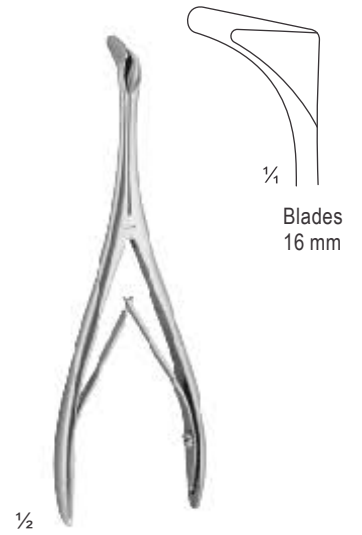

Fig. 3
VW-457
Blades
21.0 x 11.5 mm



Tieck - Halle
VW-458
13 cm

Goldsmith
(Thudichum)
VW-455 - 457
6.5 cm

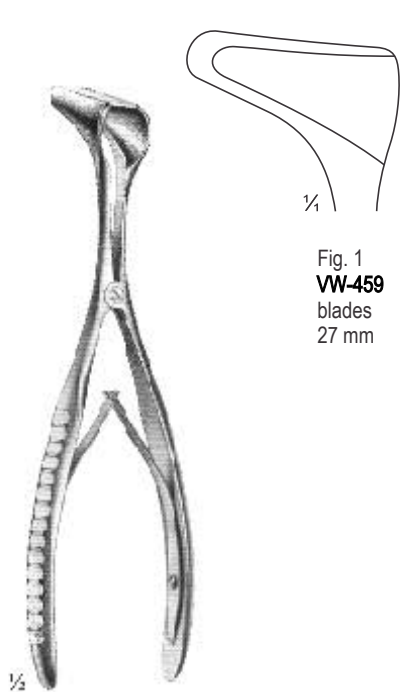

Fig. 1
VW-459
blades
27 mm

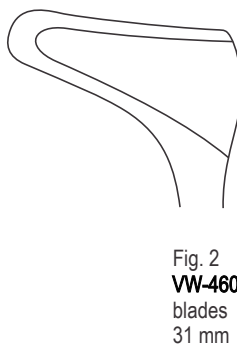

Fig. 2
VW-460
blades
31 mm

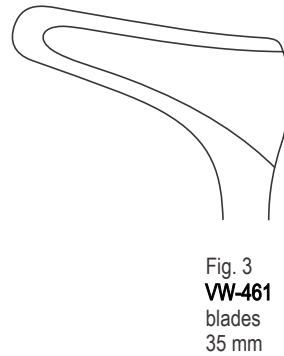

Fig. 3
VW-461
blades
35 mm

Hartmann-Halle
VW-459 - 461
16 cm



Beckmann
VW-462
15 cm



Cottle
VW-463 - 466

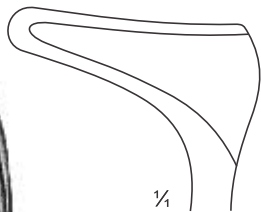

Fig. 1
VW-463
13.5 cm
Blades
35 mm

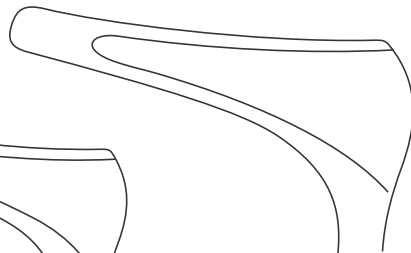

Fig. 2
VW-464
14 cm
Blades
50 mm

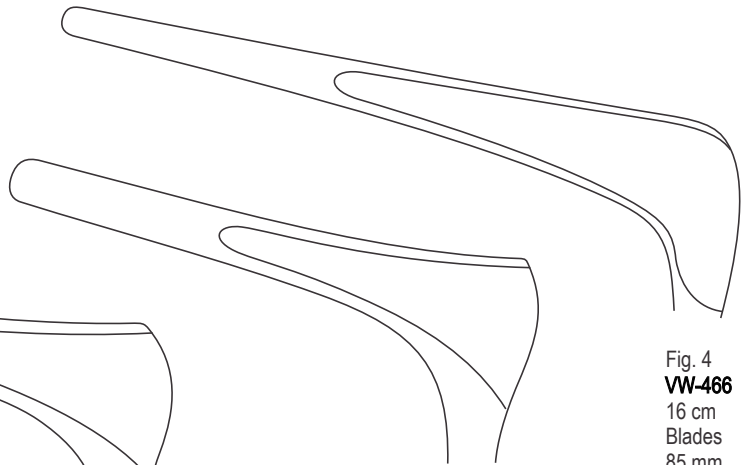

Fig. 3
VW-465
16 cm
Blades
75 mm

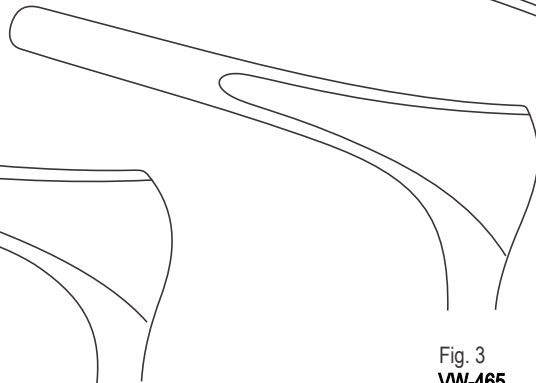
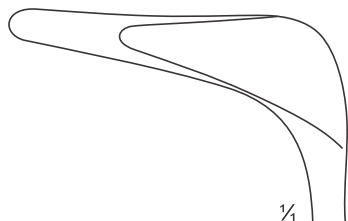

Fig. 4
VW-466
16 cm
Blades
85 mm



Cottle
VW-467 - 468



VW-467
14 cm
blades
45 mm

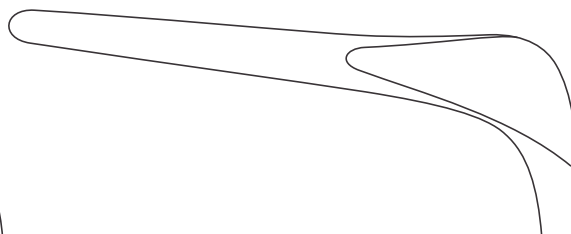

VW-468
15.5 cm
blades
75 mm