

Page 1-21

- Percussion Hammers &
- Aesthesiometers Tongue
- Depressors Diagnostic Sets
- Examination & Measuring Instruments
- Dissecting Knives
- Scalpels, Tenotomes &
- Resection Knives

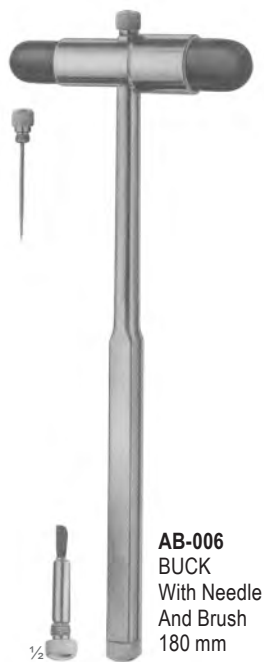

TONGUE DEPRESSORS

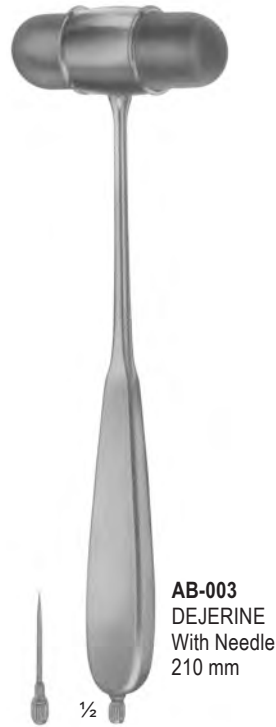
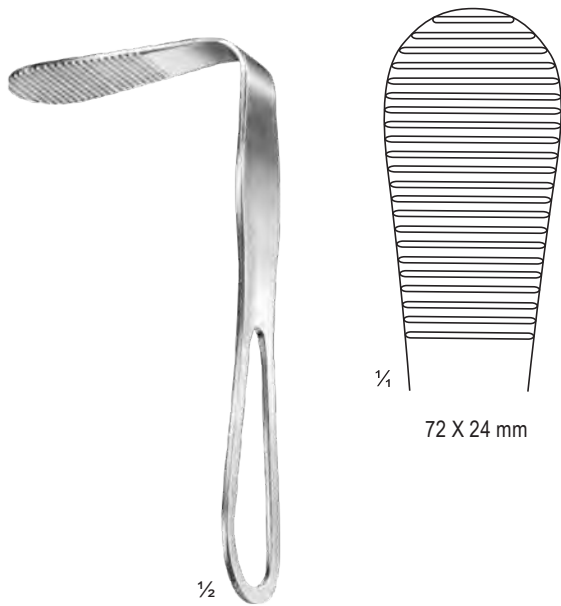

AB-010
HARTMANN
150 mm

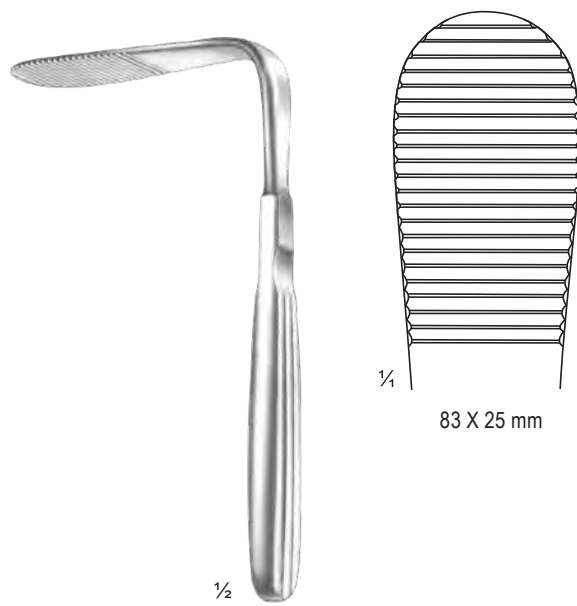

AB-011
TOBOLD
150 mm



AB-012
TOBOLD
160 mm



AB-013 - AB-014
WIEDER

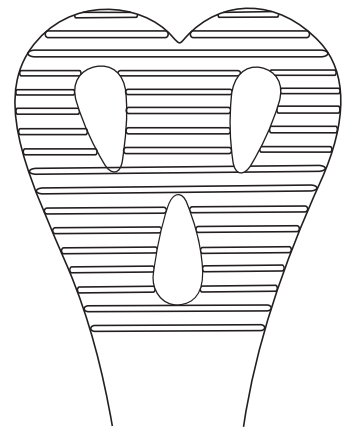

AB-013
15 cm
43 mm

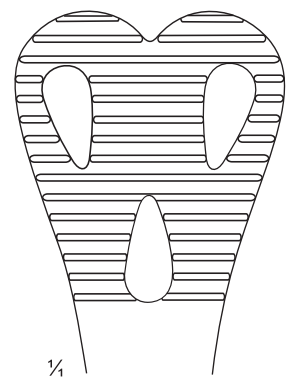

AB-014
140 mm
36 mm

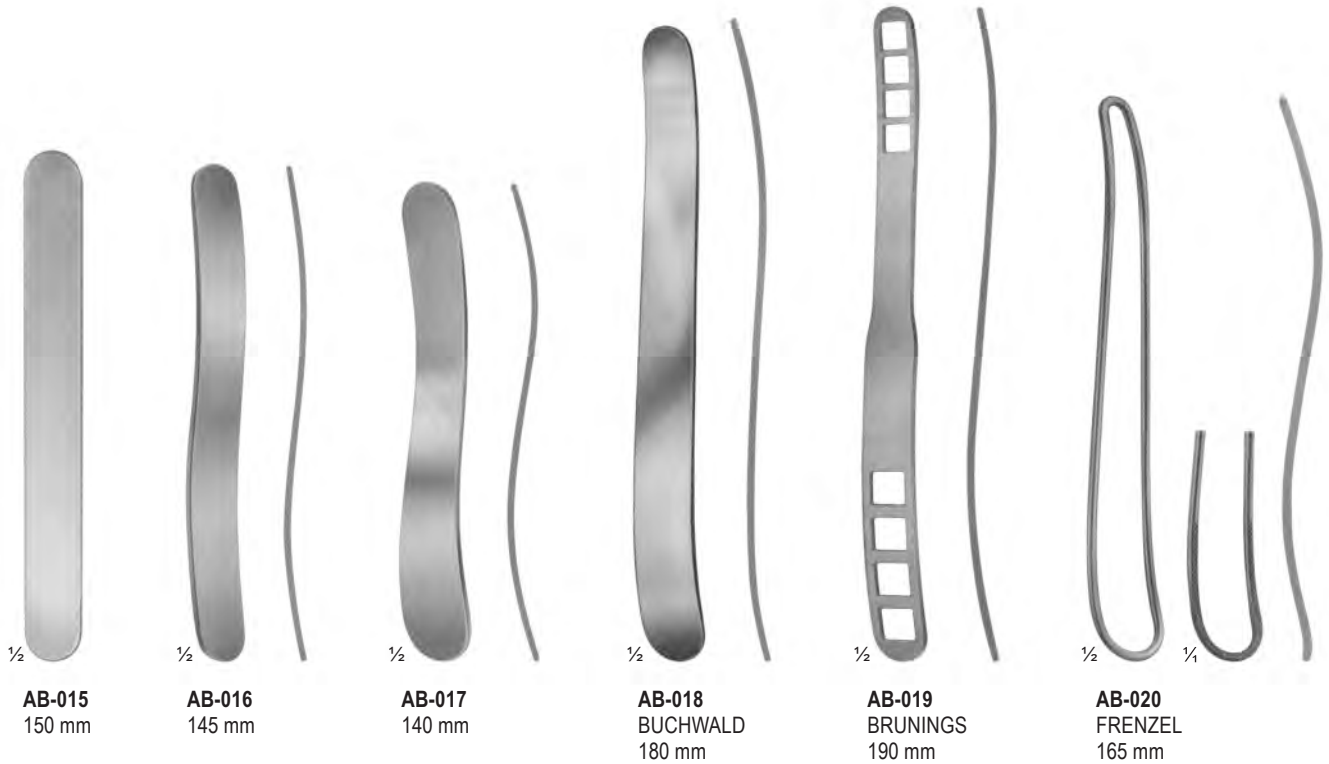

INSTRUMENTS FOR ANAESTHESIA AND TONGUE FORCEPS



1/2

AB-026
HEISTER
Mouth Gag
Size: 130 mm



1/2

AB-027
FERGUSSON-ACKLAND
Mouth Gag
Size: 145 mm



1/2

AB-028
DENHARDT
Mouth Gag With Silicon
Inserts, Interchangeable
Size: 125 mm



1/2

AB-029
ROSER KONIG
Mouth Gag
Size: 160 mm,
185 mm

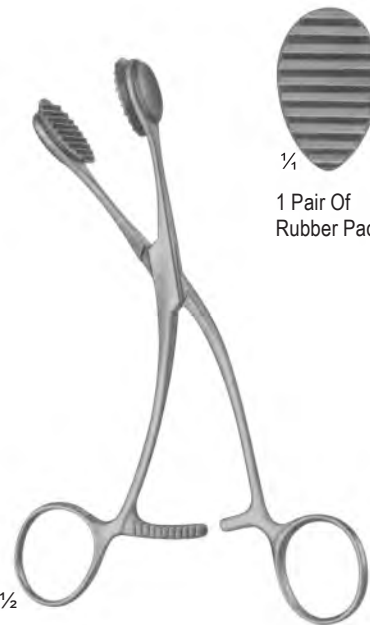

1/2

AB-030
YOUNG
165 mm



1/4
1 Pair Of
Rubber Pads

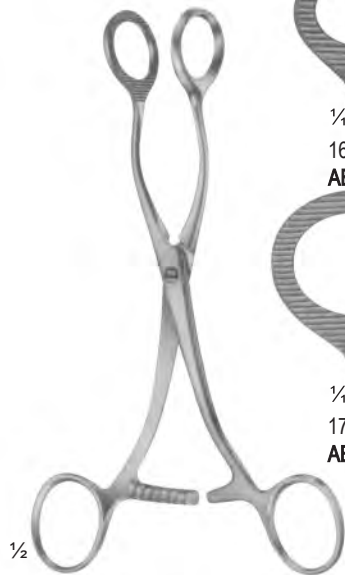

1/2

AB-031
COLLIN
160 mm, 170 mm



1/4
160 mm
AB-031



1/4
170 mm
AB-031-1

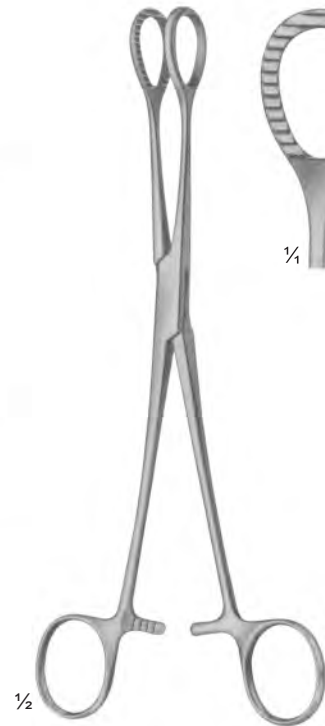

1/2

AB-032
HEYWOOD-SMITH modif.
215 mm



1/4



AB-033
Infants
150 mm



AB-034
Children
200 mm



AB-035
Adults
250 mm

1/2



AB-033 - AB-035
MAGILL



AB-036
TUBING CLAMP
7", 8"
180 mm, 200 mm



1/2
AB-037
Medium battery handle
only, 25 mm diam.



AB-038
Spare bulb
2.7 volt, for
autosopes



AB-039
Spare bulb
2.6 volt, for
ophthalmoscopes



AB-040
Otoscope Set, Consists Of
Battery Handle Without Batteries,
3 Ear Specula, 1 Bulb In Velvet Lined Case



AB-041
Diagnostic Set, Otoscope With Three Specula,
Nasal Speculam, Lamp Holder, Two Laryngeal
Mirrors, Tongue Blade Holder

DIAGNOSTIC SETS (LARYNGOSCOPE)



1/3

AB-042
MILLER
Laryngoscope Set, Consists Of Battery Handle
(Without Battery) With Four Miller
Laryngoscope Blades

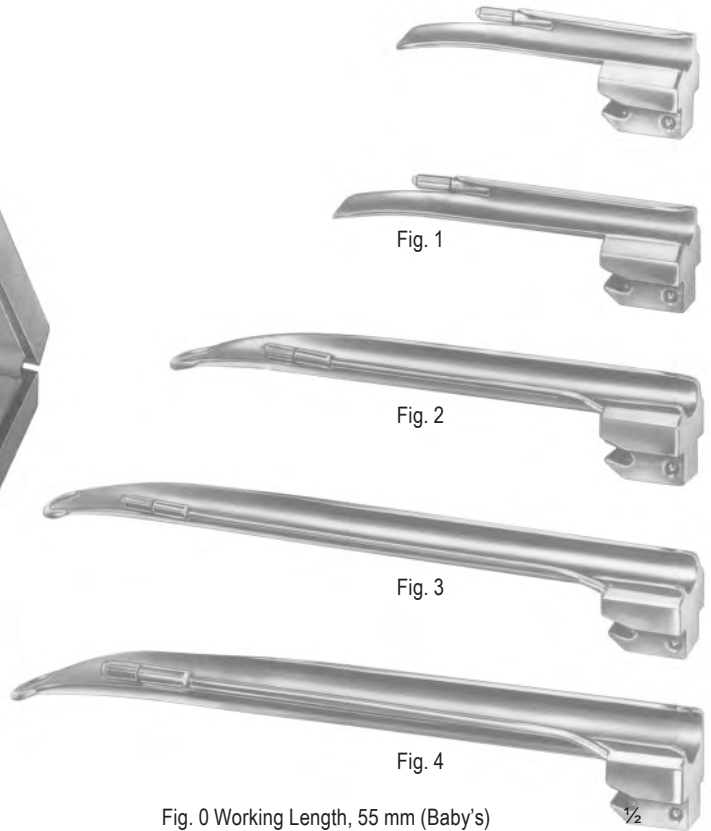

Fig. 0 Working Length, 55 mm (Baby's)
Fig. 1 Working Length, 80 mm (Children's)
Fig. 2 Working Length, 130 mm (Adolescent's)
Fig. 3 Working Length, 170 mm (Women's)
Fig. 4 Working Length, 180 mm (Men's)



1/3

AB-043
GUEDEL-NEGUS
Laryngoscope Set, Consists Of Battery Handle
(Without Battery) With Four Miller
Laryngoscope Blades

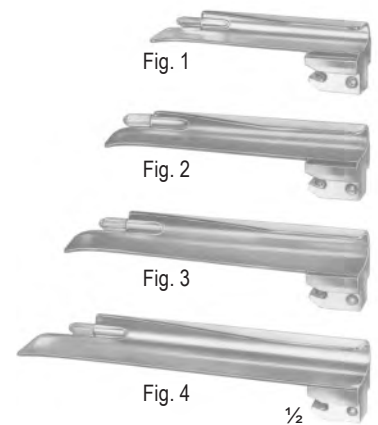

Fig. 1 Working Length, 70 mm (Children's)
Fig. 2 Working Length, 90 mm (Adolescent's)
Fig. 3 Working Length, 110 mm (Women's)
Fig. 4 Working Length, 135 mm (Men's)



AB-044
McIntosh
Laryngoscope Set, Consists Of Battery Handle
(Without Battery) With Three McIntosh Blades,
Fig. 1, Fig. 2, Fig. 3

1/3



Fig. 0



Fig. 1



Fig. 2



Fig. 3



Fig. 4

1/2

AB-045
McIntosh
Laryngoscope Set, Consists Of Battery Handle (Without Battery)
With Five McIntosh Blades, Fig. 1, Fig. 2, Fig. 3, Fig. 4, Fig. 5

Fig. 0 Working Length, 55 mm (Baby's)
Fig. 1 Working Length, 75 mm (Children's)
Fig. 2 Working Length, 90 mm (Adolescent's)
Fig. 3 Working Length, 110 mm (Women's)
Fig. 4 Working Length, 135 mm (Men's)



AB-046
6GER
Laryngoscope Set, Consists Of
Battery Handle (Without Battery)
With Three Foregger Blades,
Fig. 1, Fig. 2, Fig. 3,

1/3



Fig. 1



Fig. 2



Fig. 3



Fig. 4

1/2

AB-047
FOREGGER
Laryngoscope Set, Consists Of
Battery Handle (Without Battery)
With Five Foregger Blades,
Fig. 1, Fig. 2, Fig. 3, Fig. 4, Fig. 5

Fig. 1 Working Length, 70 mm (Children's)
Fig. 2 Working Length, 90 mm (Adolescent's)
Fig. 3 Working Length, 110 mm (Women's)
Fig. 4 Working Length, 135 mm (Men's)



1/2

AB-048
Fiber Optic
Battery Handle



1/2

AB-049
Fiber Optic
Battery Handle



1/4

AB-050
Replacement Lamp
(Krypton) 2.5 V



1/4

AB-051
Replacement Lamp
(Halogen) 2.5 V



EXAMINATION & MEASURING INSTRUMENTS



AB-052
Boley



Metal: **AB-053**
Wax : **AB-054**
Double Side Marking
Iwanson



AB-055
CAROLL
140 mm



AB-056
TOWNLEY
100 mm



AB-057
BERTILLON
Caliper For Measuring The Head
320 mm



AB-058
CASTROVIEJO
Caliper



AB-059
MOLTGEN
Goniometer



1/2

AB-060 - AB-069
Fig. 1 - 10



1/4

AB-060
Fig. 1



AB-061
Fig. 2



AB-062
Fig. 3



AB-063
Fig. 4



AB-064
Fig. 5



1/4

AB-065
Fig. 6



AB-066
Fig. 7



AB-067
Fig. 8



AB-068
Fig. 9



AB-069
Fig. 10



SCALPELS, TENOTOMES & RESECTION KNIVES

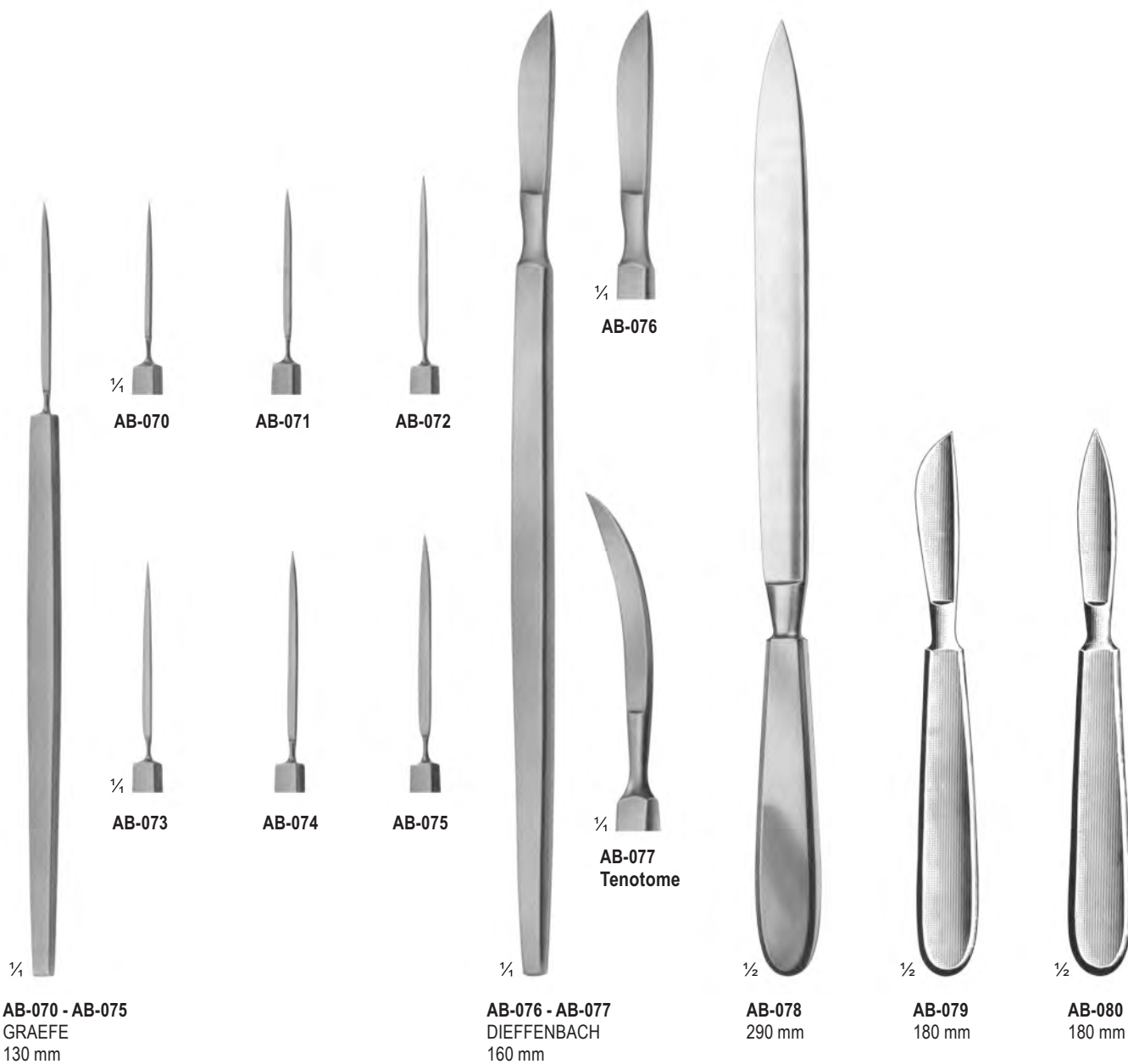



AB-081
130 mm
AB-082
160 mm
AB-083
190 mm
AB-084
200 mm

AB-085
CATLIN
160 mm
Blade Length
Amputating
Knives

AB-086
LANGENBECK
120 mm
Blade Length
Flap Knives

AB-087
110 mm
Blade Length
Interosseous
Knives

AB-088
55 mm
Blade Length
With Raspatory,
Wooden Handle

AB-089
70 mm
Blade Length
Wooden Handle

AB-090
80 mm
Blade Length
Metal Handle

AB-091
195 mm
Blade Length
Metal Handle

Blade Length
Amputating Knives



CONE KNIVES, MYOMATOME, TRIGEMINAL & TONSIL KNIVES



AB-092
AYRE
235 mm
Cone Knife

AB-093
230 mm
Cone Knife

AB-094
SEGOND
270 mm
Myomatome

AB-095
OLIVECRONA
205 mm
Trigeminal
Knife

AB-096
230 mm
Trigeminal
Knife

AB-097
FOWLER
200 mm
Tonsil Knife

AB-098
ABRAHAM
215 mm
Tonsil Knife

AB-099
BRUNINGS
215 mm
Tonsil Knife

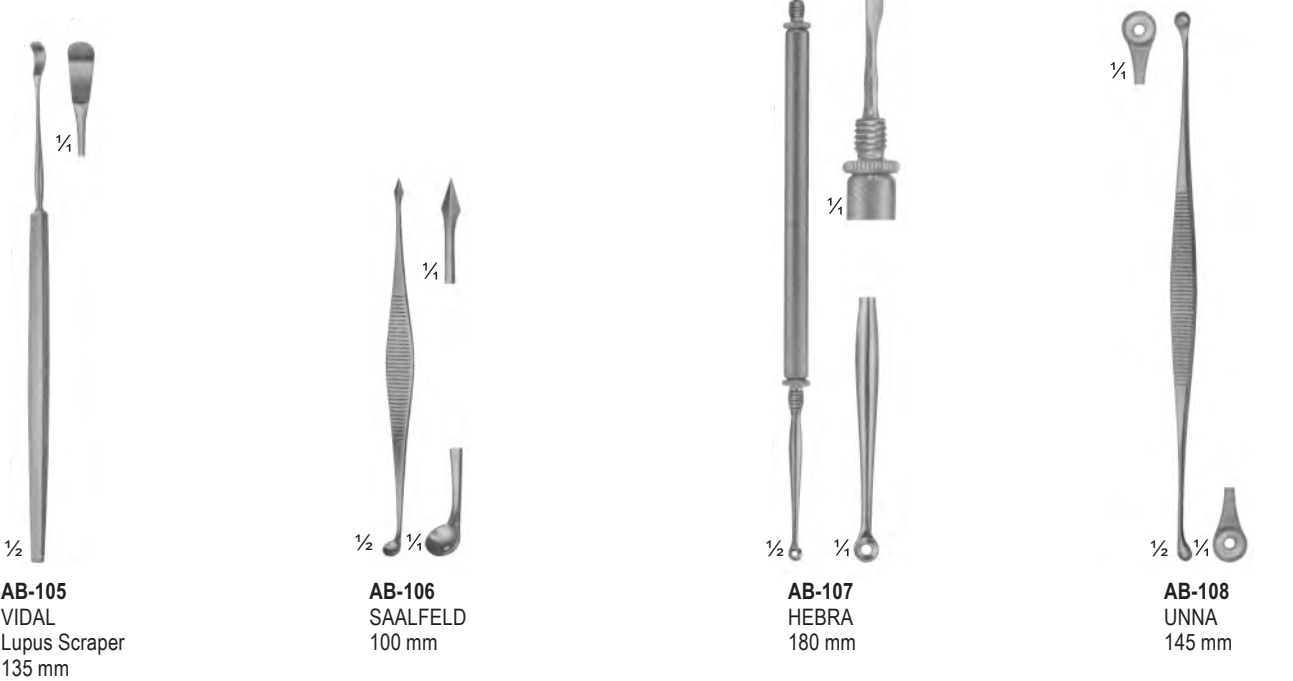
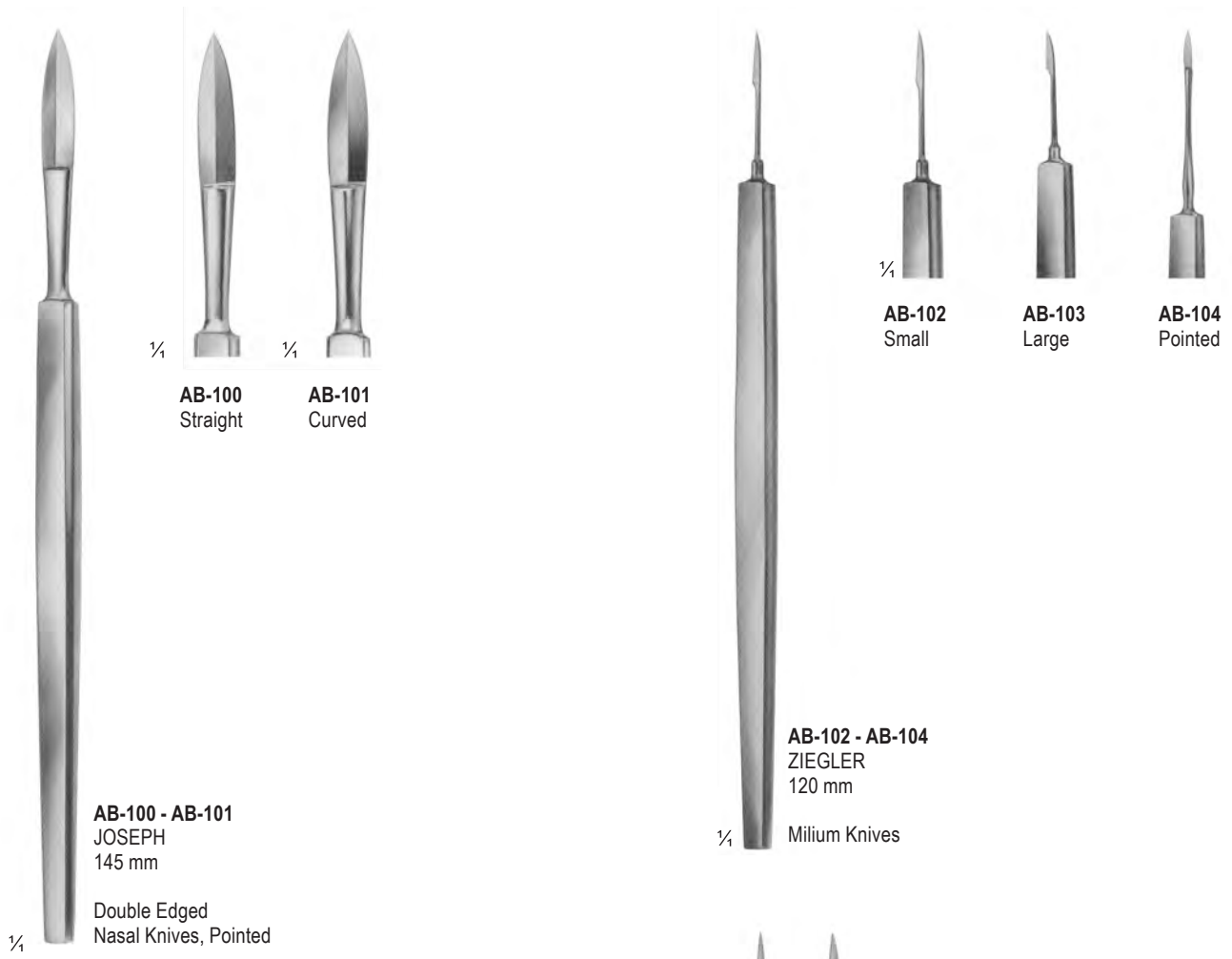

SCALPEL HANDLES

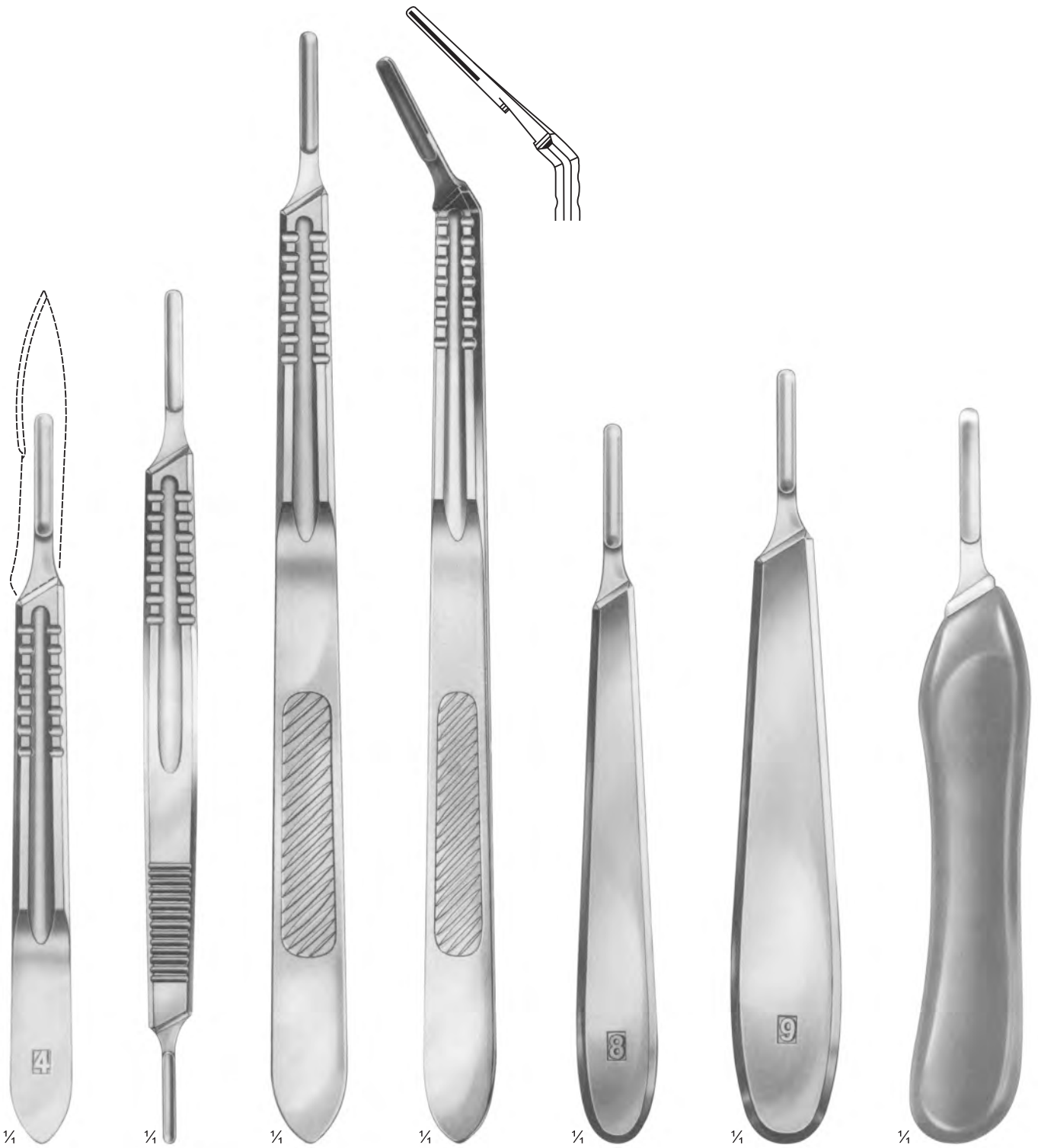

AB-109
STANDARD
No. 4
Solid

AB-110
Double Handle
No. 4 + No. 3
Solid

AB-111
No. 4 L
Straight
Solid

AB-112
No. 4 L
Solid Angled

AB-113
COLLIN
No. 8
Hollow

AB-114
COLLIN
No. 9
Hollow

AB-115
Plastic

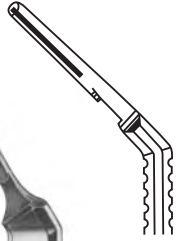

¼
AB-116
 STANDARD
 No. 3
 Solid



¼
AB-117
 No. 3
 Solid



¼
AB-118
 No. 3
 Solid



¼
AB-119
 No. 3 L
 Straight
 Solid



¼
AB-120
 No. 3 L
 Angled
 Solid



SCALPEL HANDLES



AB-121
No. 7
Solid



AB-122
No. 7 K
Solid



AB-123
Hollow-Round



AB-124
No. 3
Straight
Solid



AB-125
25.5 cm



AB-126
VIRCHOW



AB-127 - AB-129
VIRCHOW

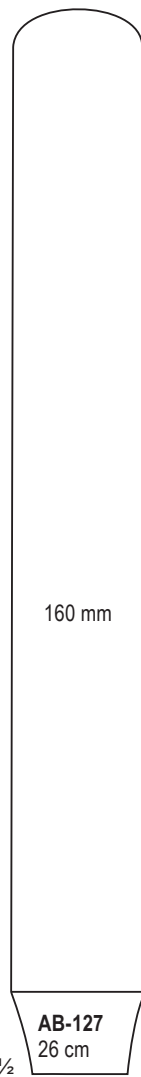

AB-127
26 cm



AB-128
33.5 cm

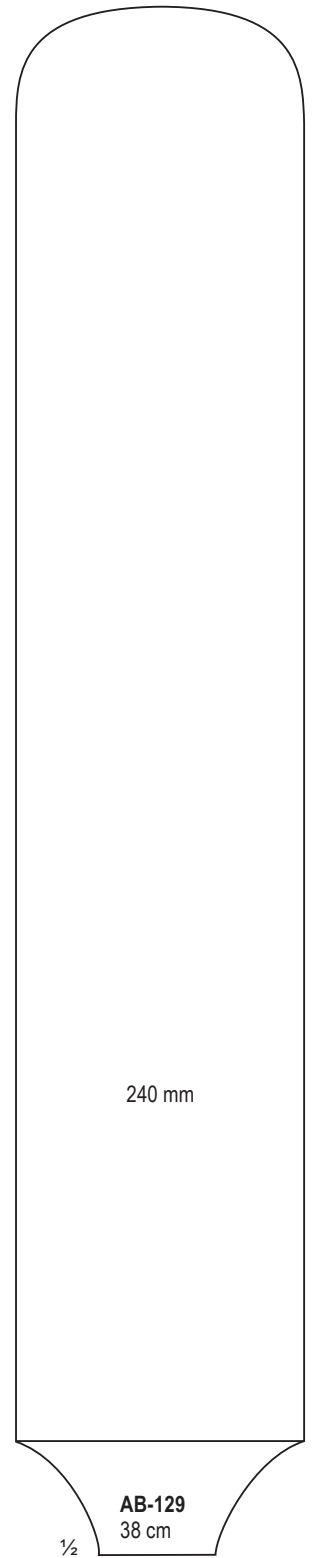

AB-129
38 cm



RAZOR BLADE HOLDERS & BREAKERS

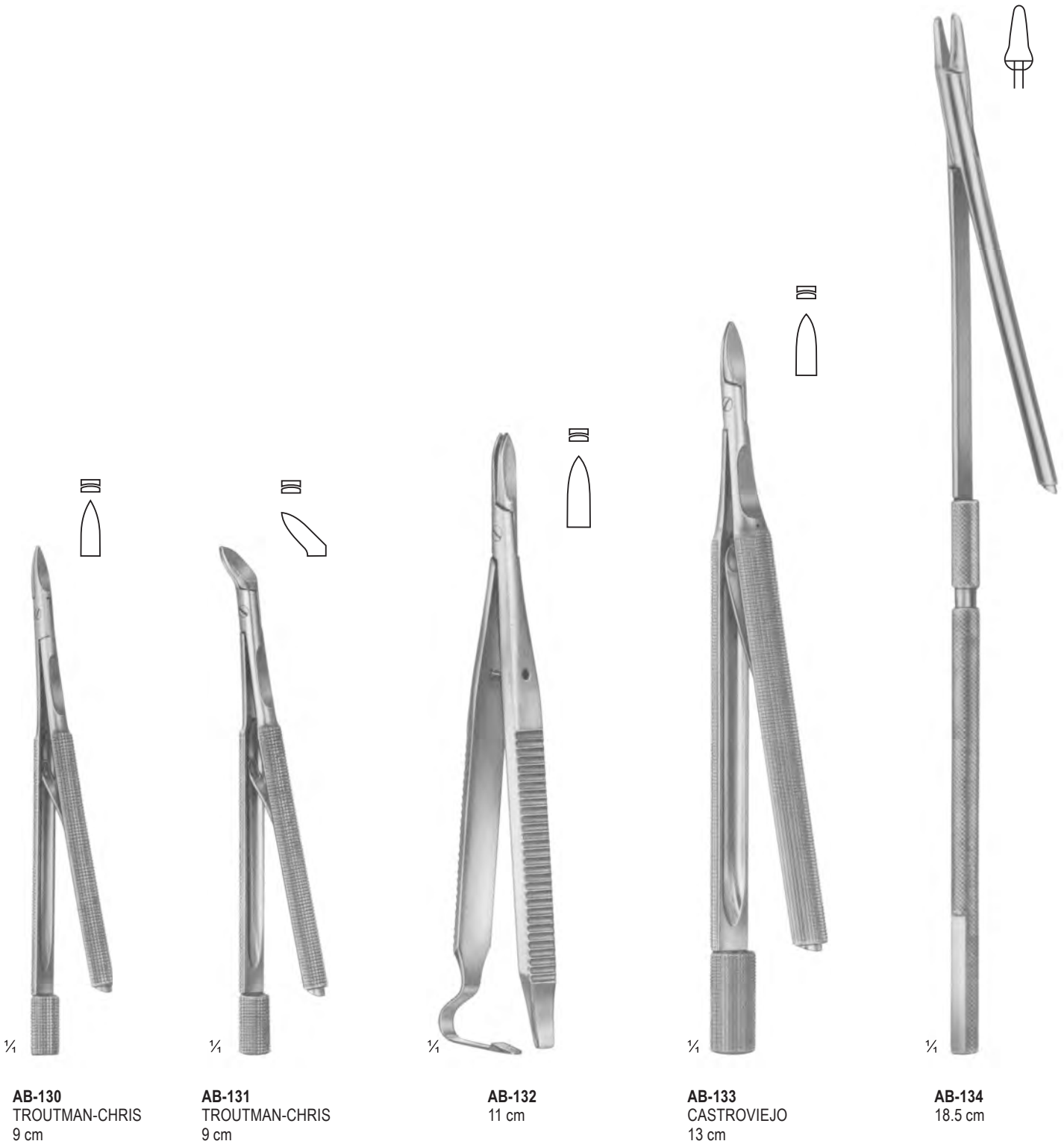



HUMBY
AB-135

1/2

HUMBY
AB-135
32 cm



SCHINK
AB-136

1/2

AB-136
SCHINK
30 cm



1/2

AB-137
SILVER
19.5 cm



GUM, PHALANGEAL AND SKIN GRAFTING KNIVES

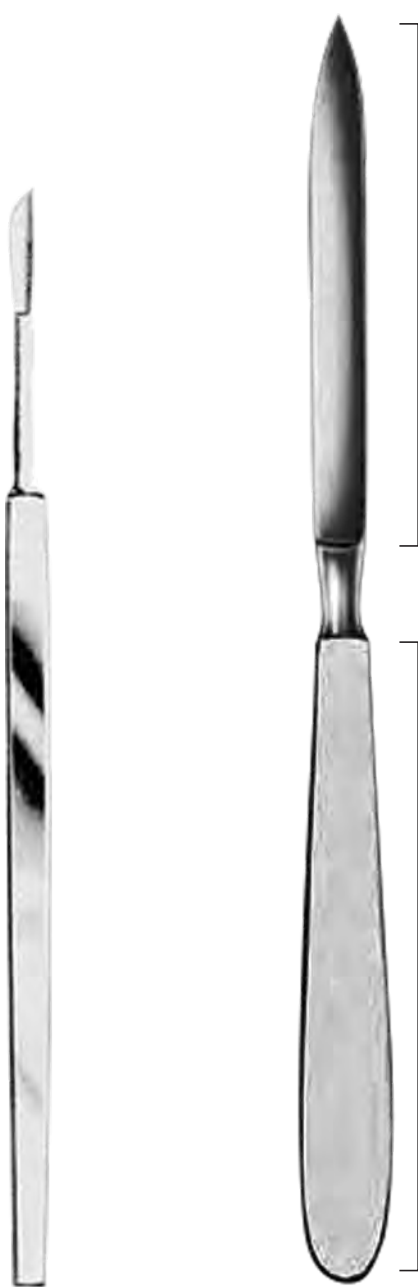

AB-138
PARKER

AB-139



AB-140
COBBETT



AB-141
BRAITHWATTE



Spare Blade



AB-142
HUMBY
35 cm



AB-143
WATSON
30 cm