

# Page 01–35

- Abdominal Surgery
- Intestinal and Rectal Instruments

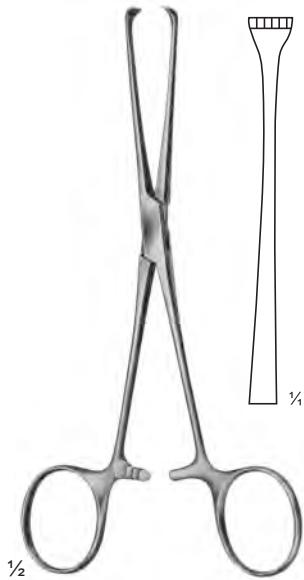

**JK-001**  
BOYS-ALLIS  
5 X 6 teeth, sharp  
155 mm,

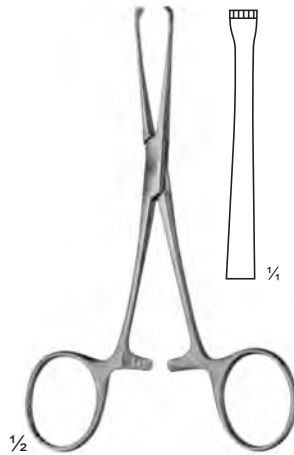

**JK-002**  
ALLIS  
4 X 5 teeth  
155 mm,  
**JK-002-1**  
ALLIS  
4 X 5 teeth  
120 mm,

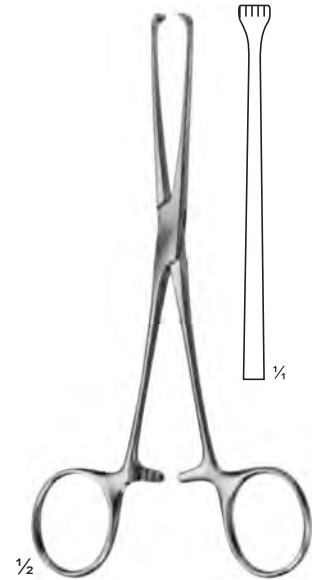

**JK-003**  
ALLIS  
155 mm,  
4 X 5 teeth

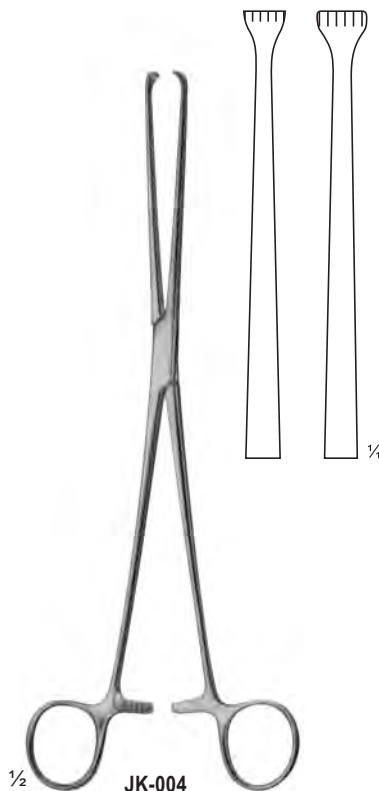

**JK-004**  
ALLIS  
190 mm,  
**JK-005**    **JK-005-1**  
255 mm,    200 mm,  
5 X 6 teeth    5 X 6 teeth

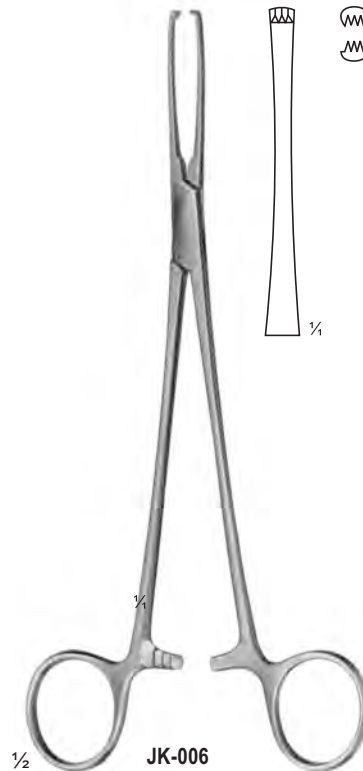

**JK-006**  
JUDD-ALLIS  
3 X 4 teeth  
195 mm,

INTESTINAL GRASPING FORCEPS

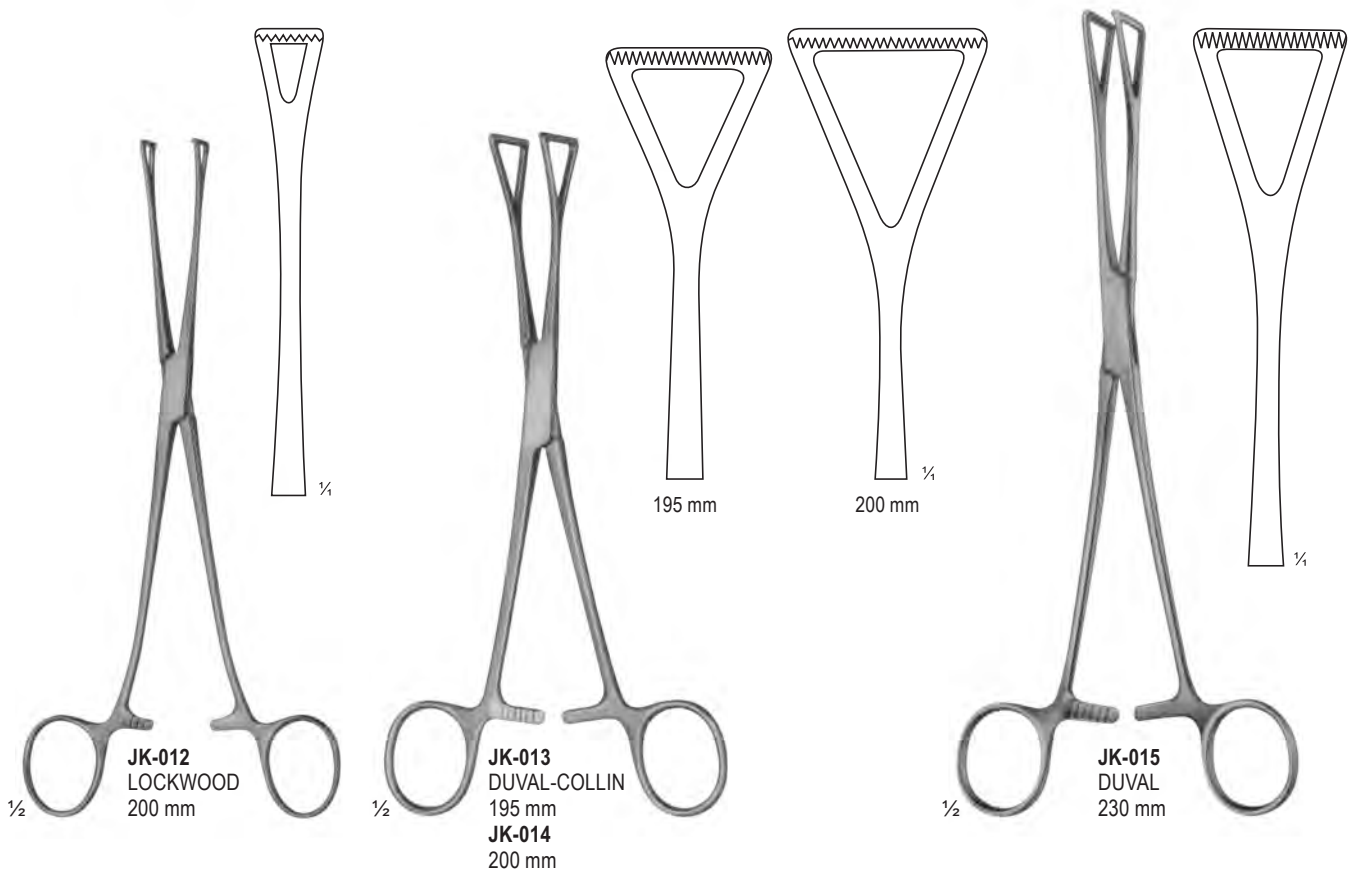
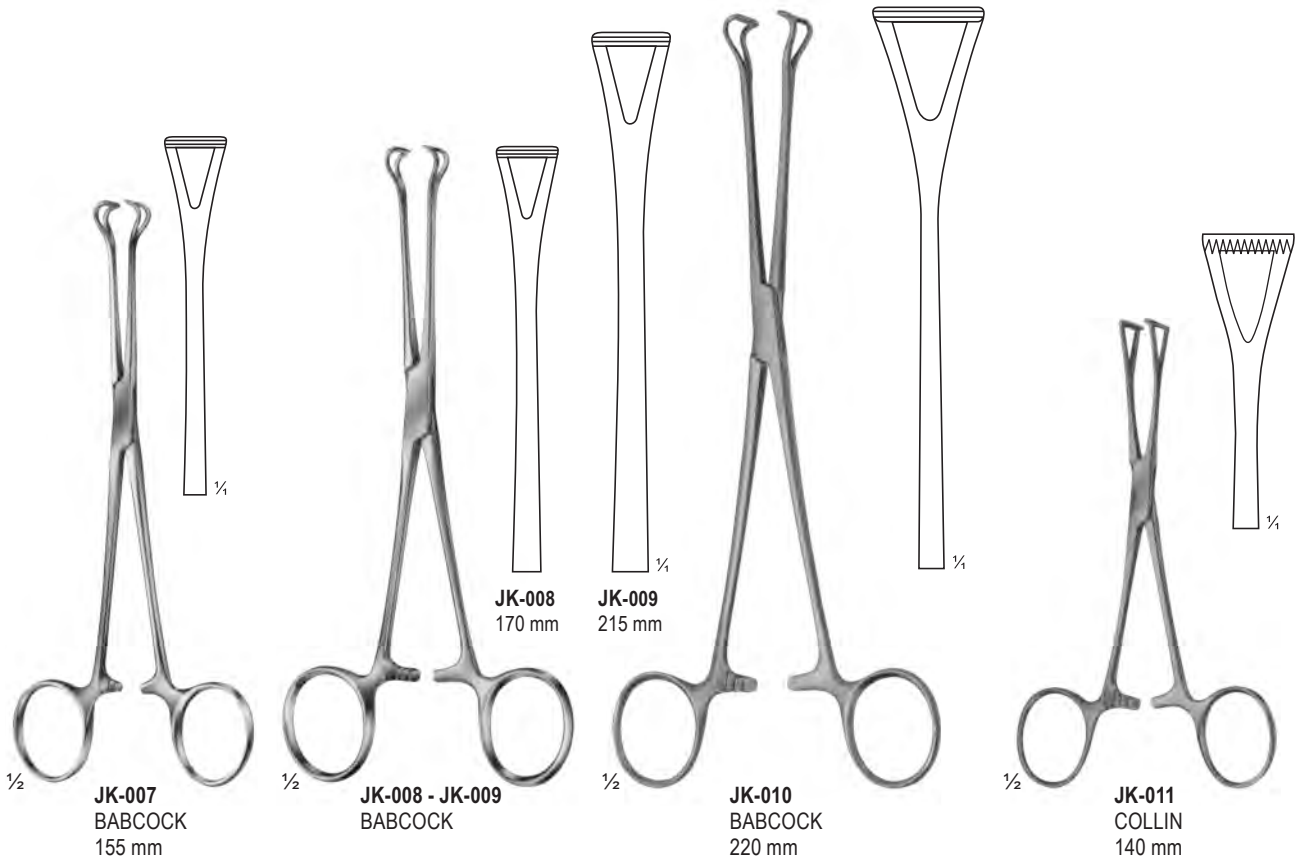

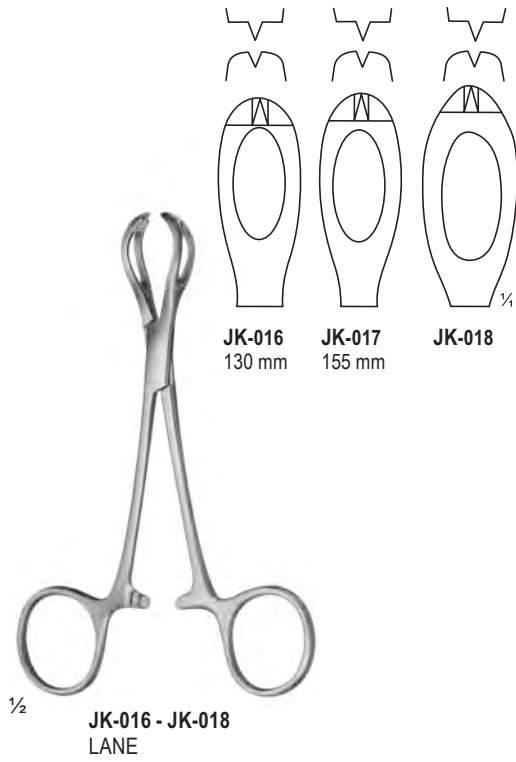

ORGAN- TISSUE GRASPING, DISSECTING AND INTESTINAL FORCEPS

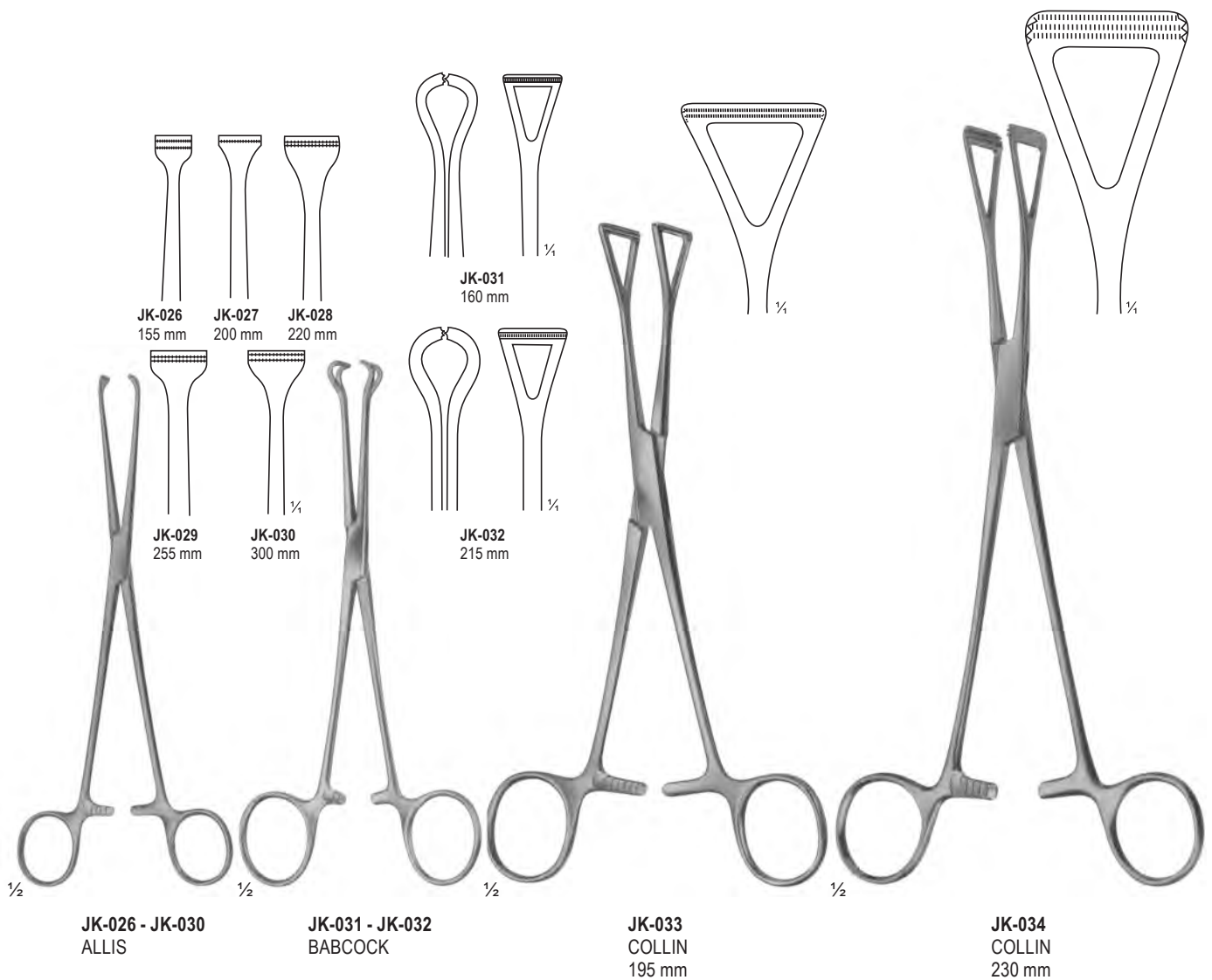

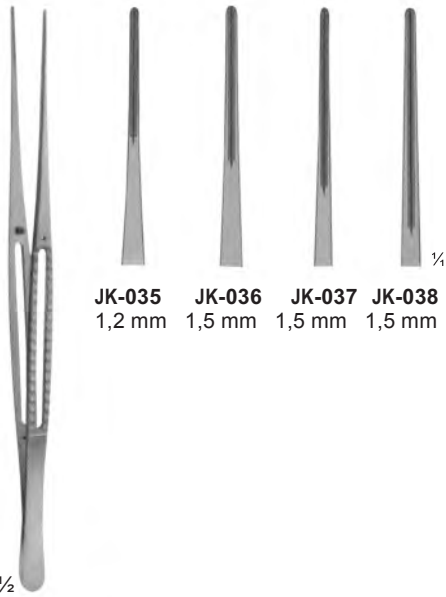

**JK-035** 150 mm  
**JK-036** 200 mm  
**JK-037** 240 mm  
**JK-038** 300 mm

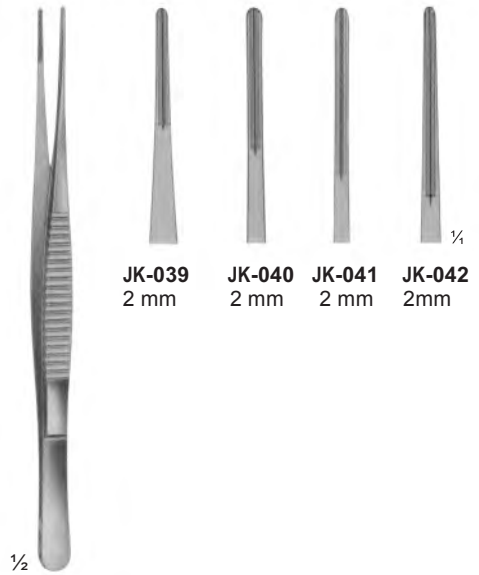

DE BAKEY  
**JK-039** 150 mm  
**JK-040** 200 mm  
**JK-041** 240 mm  
**JK-042** 300 mm

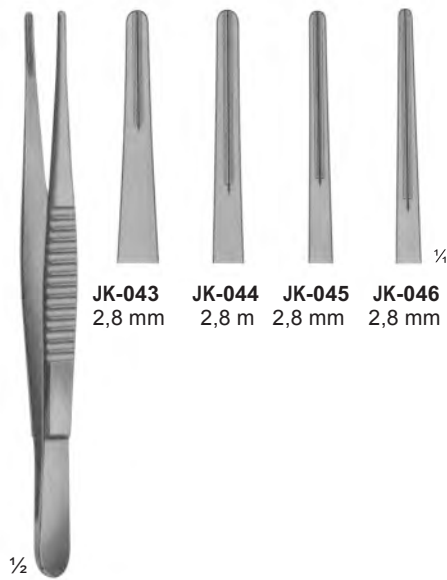

DE BAKEY  
**JK-043** 150 mm  
**JK-044** 200 mm  
**JK-045** 240 mm  
**JK-046** 300 mm

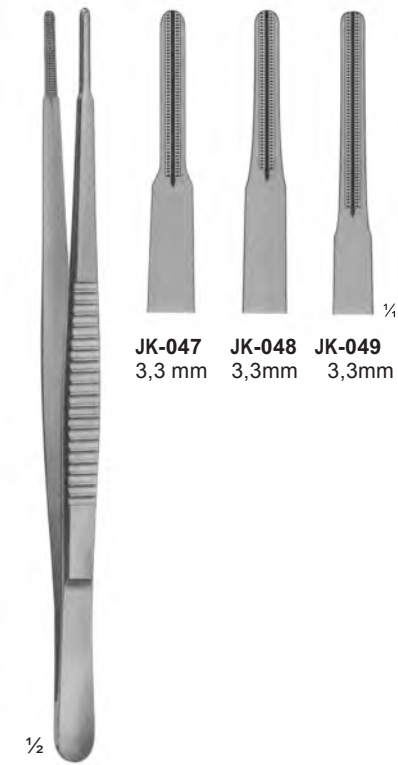

DE BAKEY  
**JK-047** 200 mm  
**JK-048** 240 mm  
**JK-049** 300 mm



INTESTINAL CLAMPS FOR CHILDREN

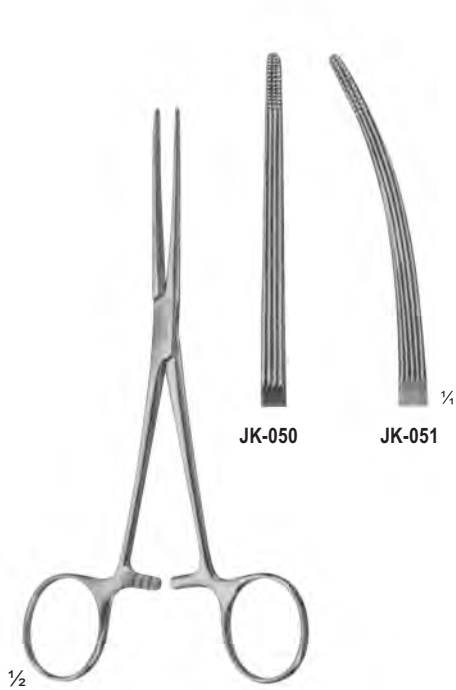

**JK-050 - JK-051**  
BAINBRIDGE  
155 mm

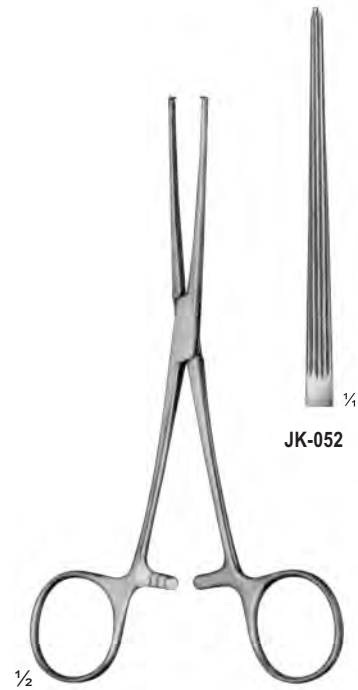

**JK-052**  
ALLEN  
155 mm

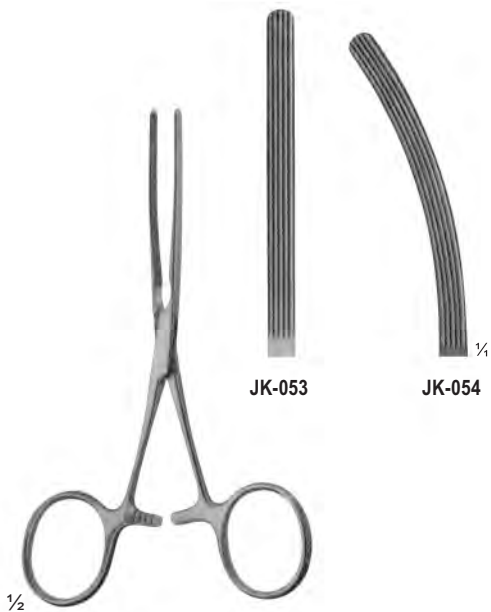

**JK-053 - JK-054**  
BABY-KOCHER  
very elastic blades  
130 mm

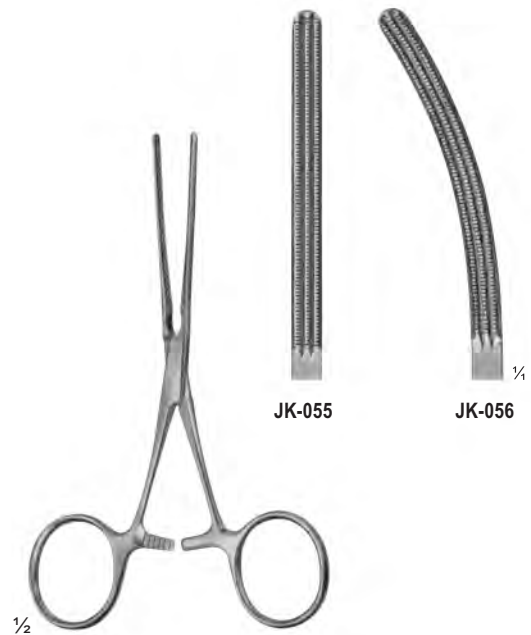

**JK-055 - JK-056**  
BABY-KOCHER  
with elastic blades  
130 mm

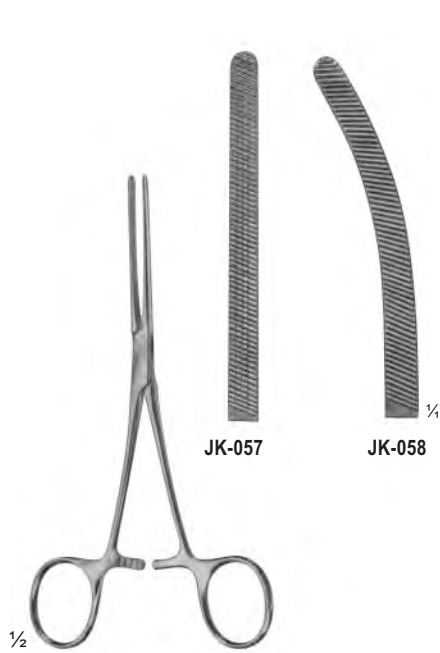

**JK-057 - JK-058**  
DOYEN  
elastic  
165 mm

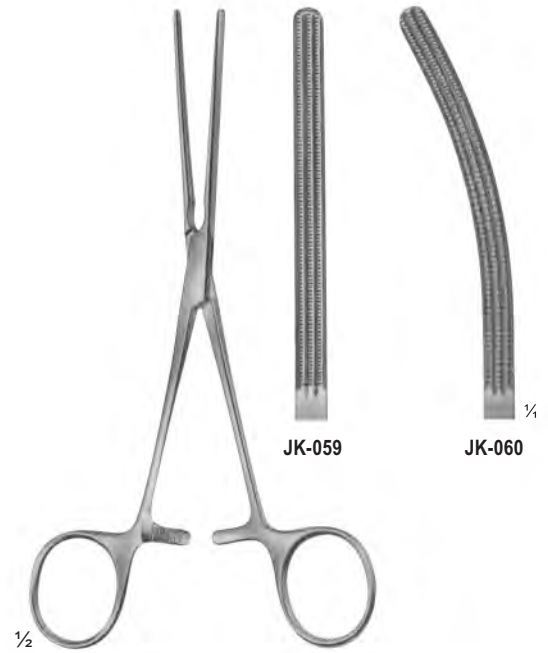

**JK-059 - JK-060**  
DOYEN  
with elastic blades  
170 mm

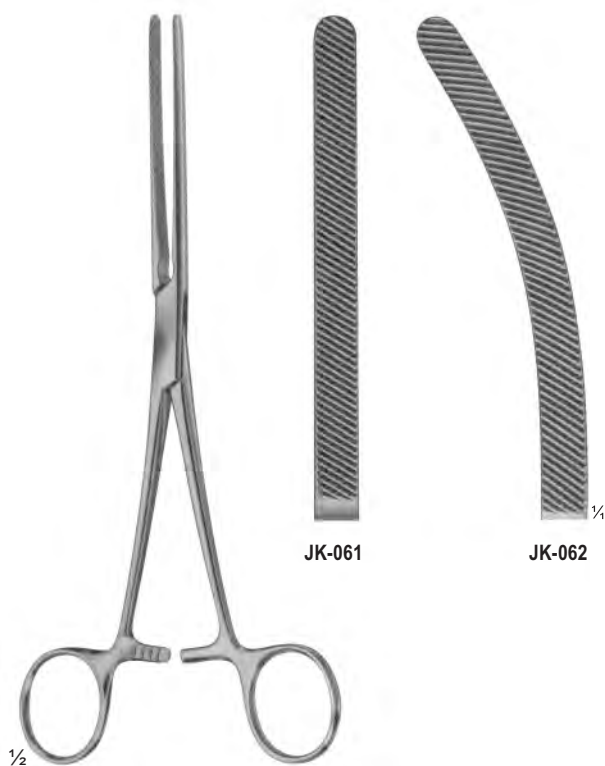

**JK-061 - JK-062**  
HARTMANN  
with elastic blades  
200 mm



**JK-063 - JK-064**  
HARTMANN  
with elastic blades  
200 mm





INTESTINAL CLAMPS, SOFT ELASTIC

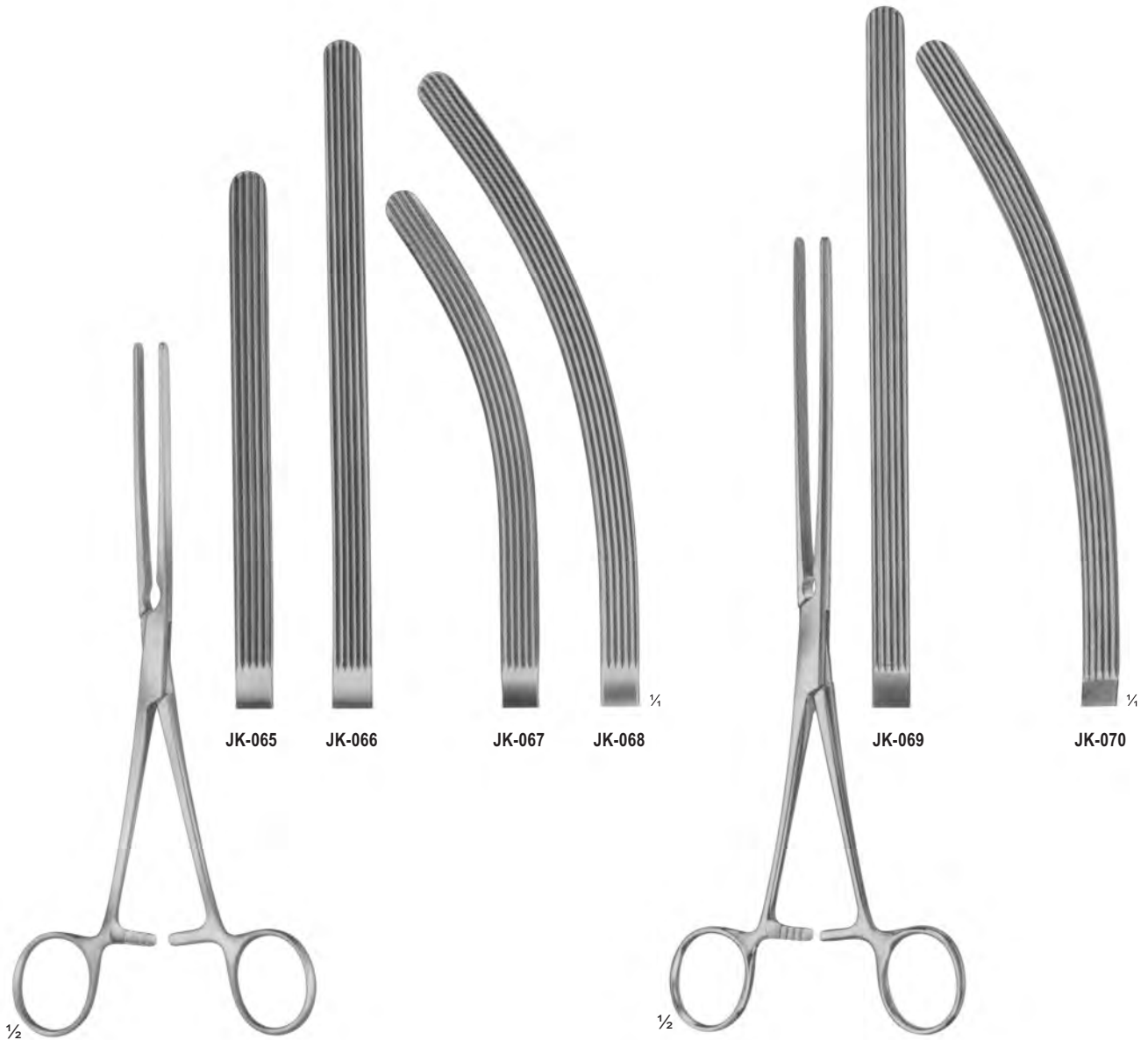

**JK-065 - JK-068**  
KOCHER  
with elastic blades  
**JK-067** 210 mm  
**JK-068** 230 mm

**JK-069 - JK-070**  
DOYEN  
with elastic blades  
210 mm

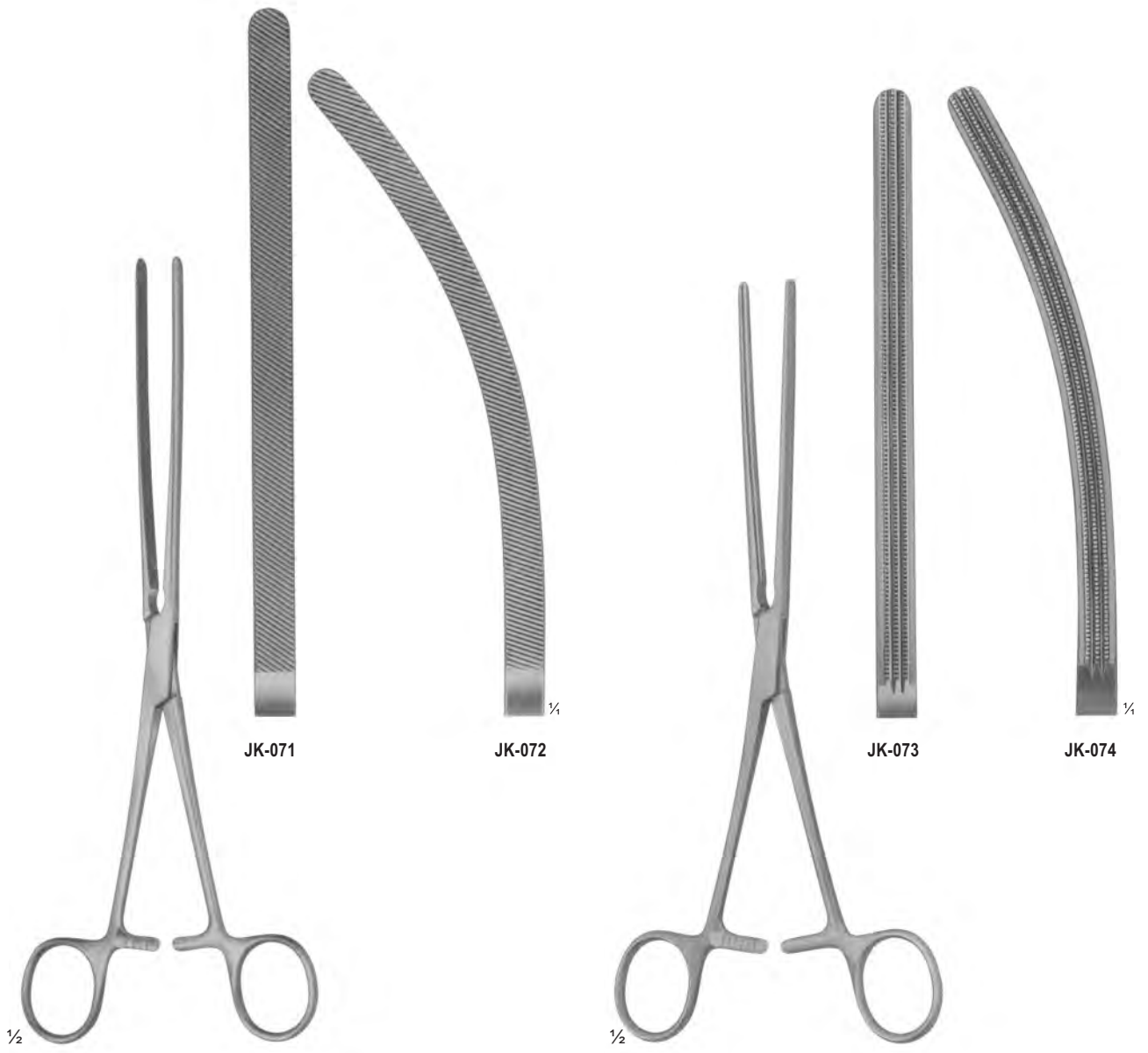

**JK-071 - JK-072**  
DOYEN  
with elastic blades  
235 mm

**JK-073 - JK-074**  
DOYEN  
with elastic blades  
230 mm



INTESTINAL CLAMPS, SOFT ELASTIC

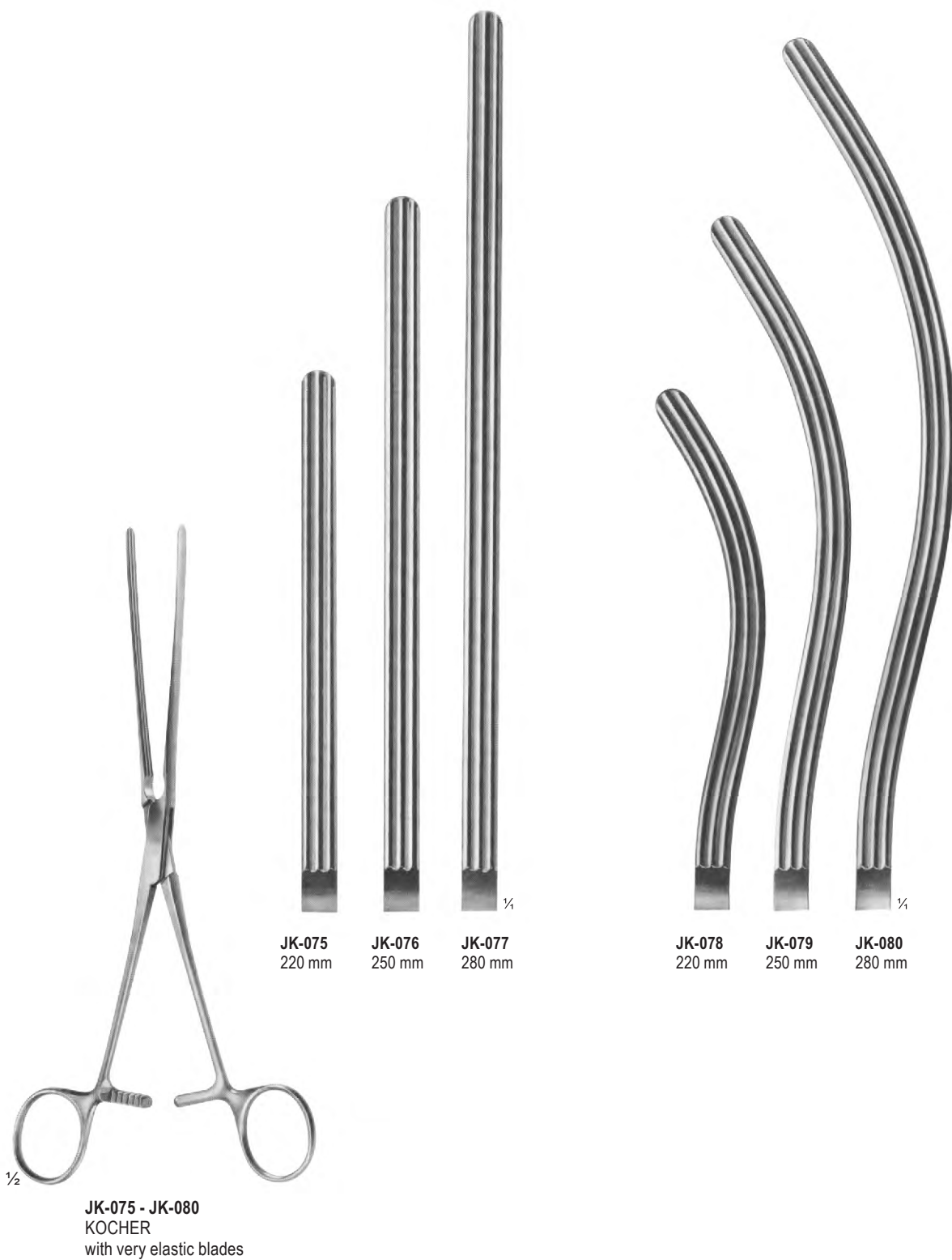

JK-075 - JK-080  
KOCHER  
with very elastic blades

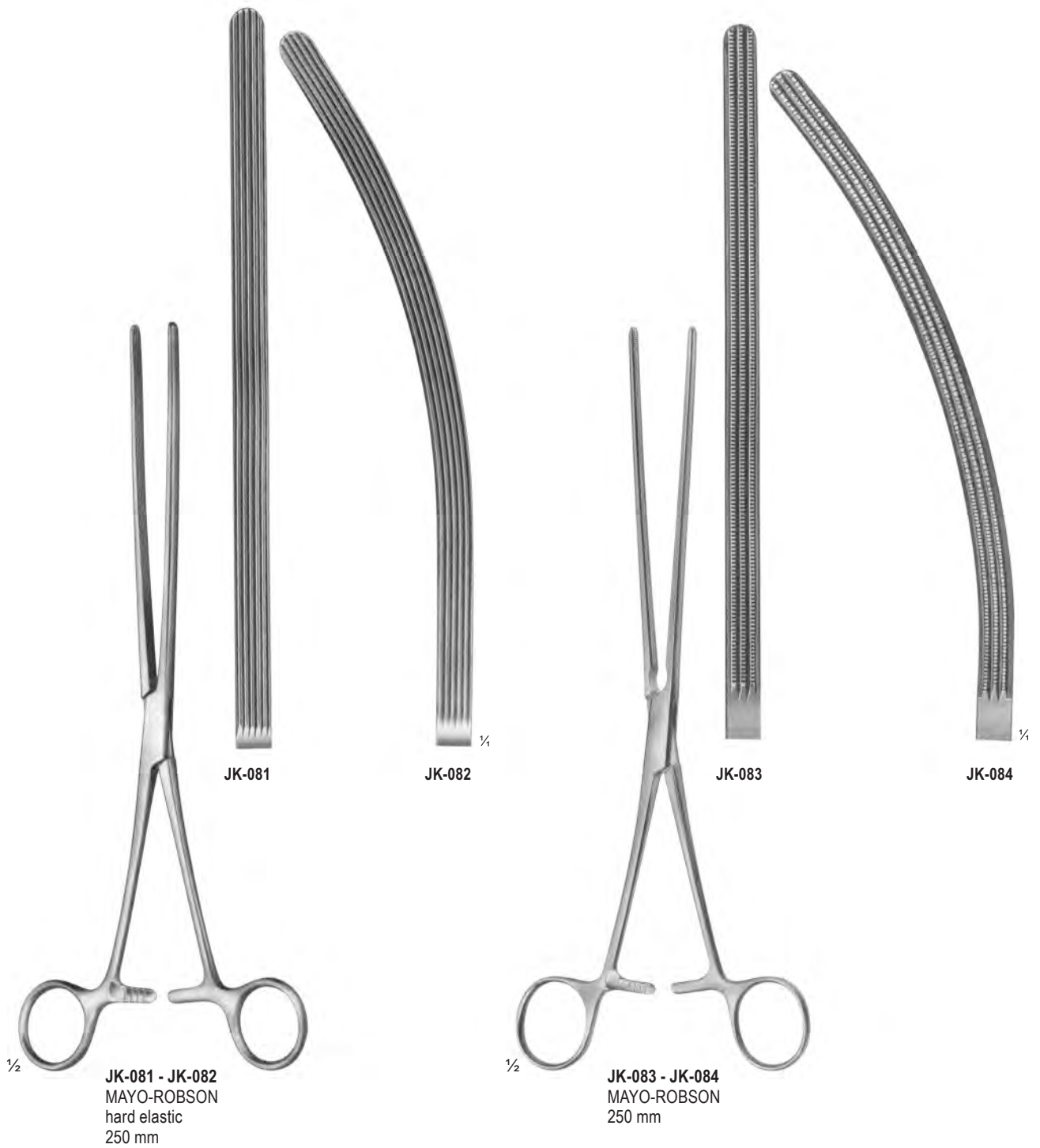



STOMACH CLAMPS

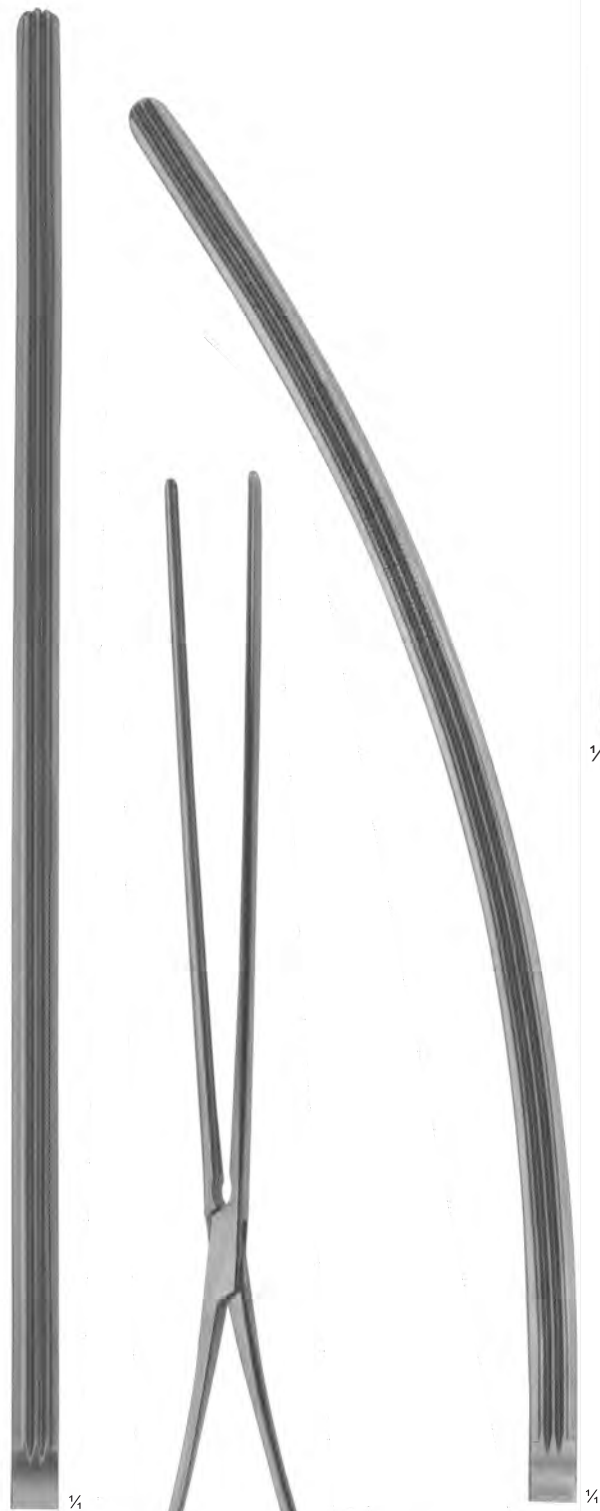

JK-085

JK-086

1/2

JK-085 - JK-086  
SCUDDER  
330 mm



1/2

1/4

JK-087  
KLEINSCHMIDT  
Spur crushers and  
Appendectomy clamps  
130 mm

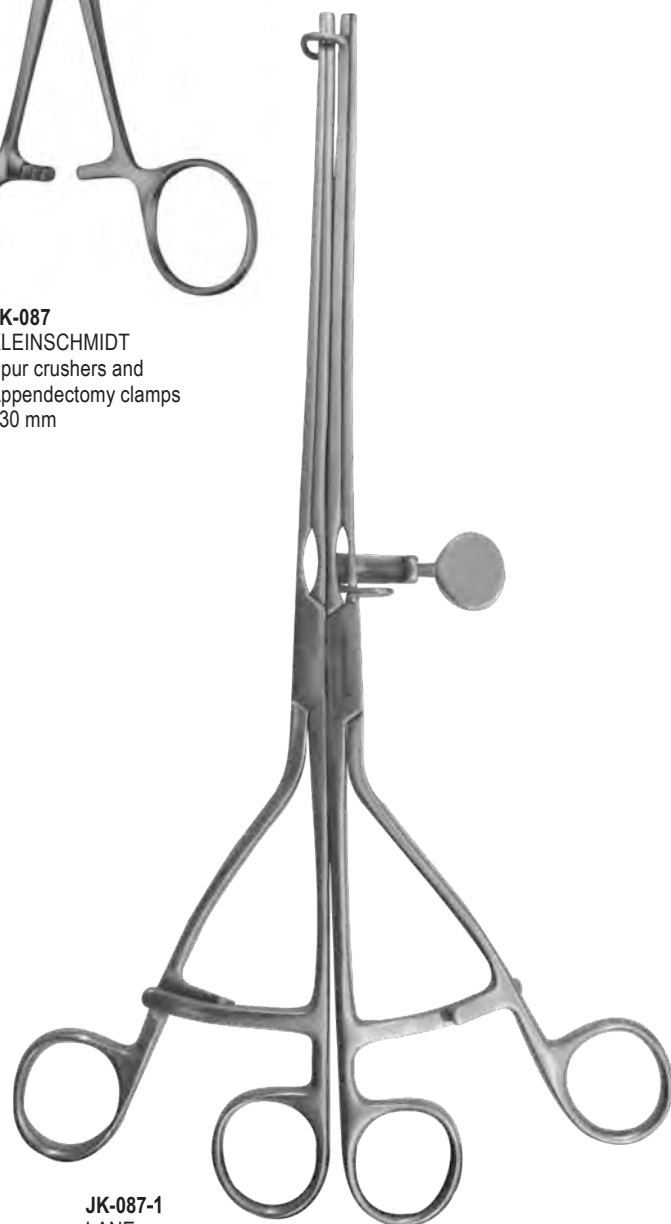

JK-087-1  
LANE  
310 mm, 12"



**JK-088 JK-088-1**  
 PAYR PAYR  
 180 mm 150 mm  
 Intestinal clamp light  
 pattern, for children

**JK-089**  
 PAYR  
 200 mm

**JK-090**  
 PAYR  
 275 mm

**JK-091**  
 PAYR  
 Pylorus clamp  
 315 mm



INTESTINAL CLAMPS, SOFT ELASTIC



BRUNNER  
JK-092  
230 mm

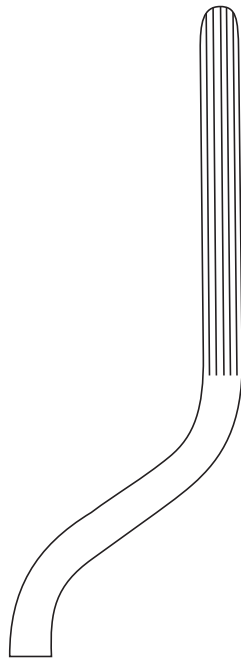

FEHLÄND  
JK-093  
240 mm



KOCHER  
with very elastic blades  
JK-094 - JK-096  
JK-094 22 cm  
JK-095 25 cm  
JK-096 28 cm



Straight



KOCHER  
with very elastic blades  
JK-097 - JK-099  
JK-097 22 cm  
JK-098 25 cm  
JK-099 28 cm



Curved

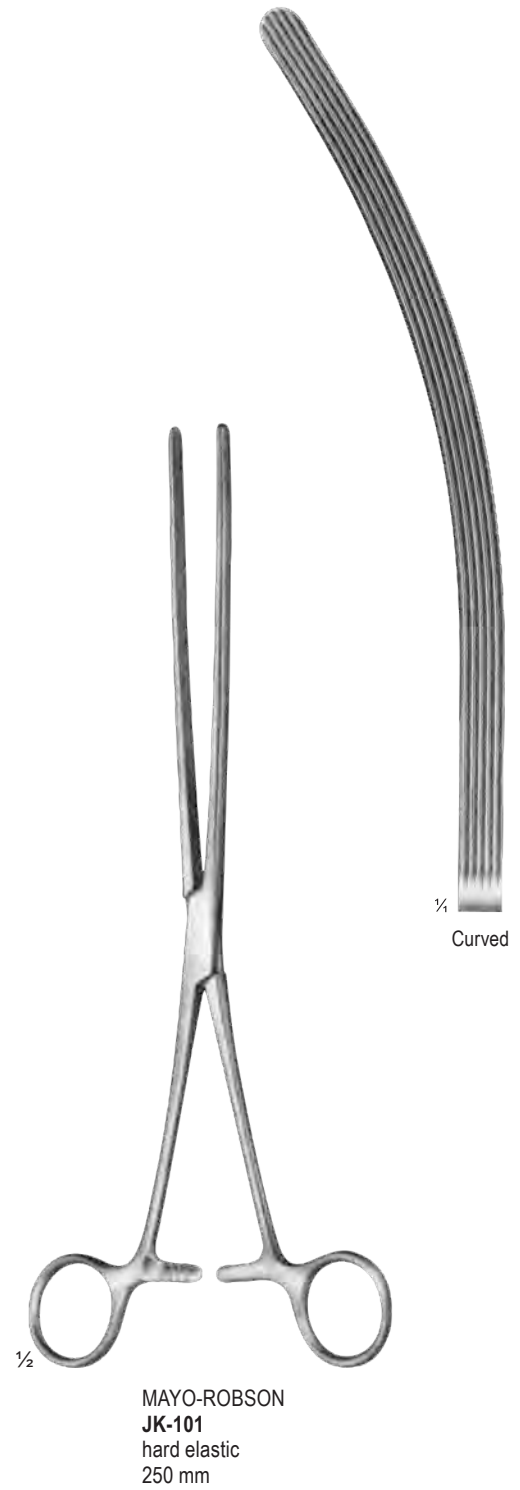
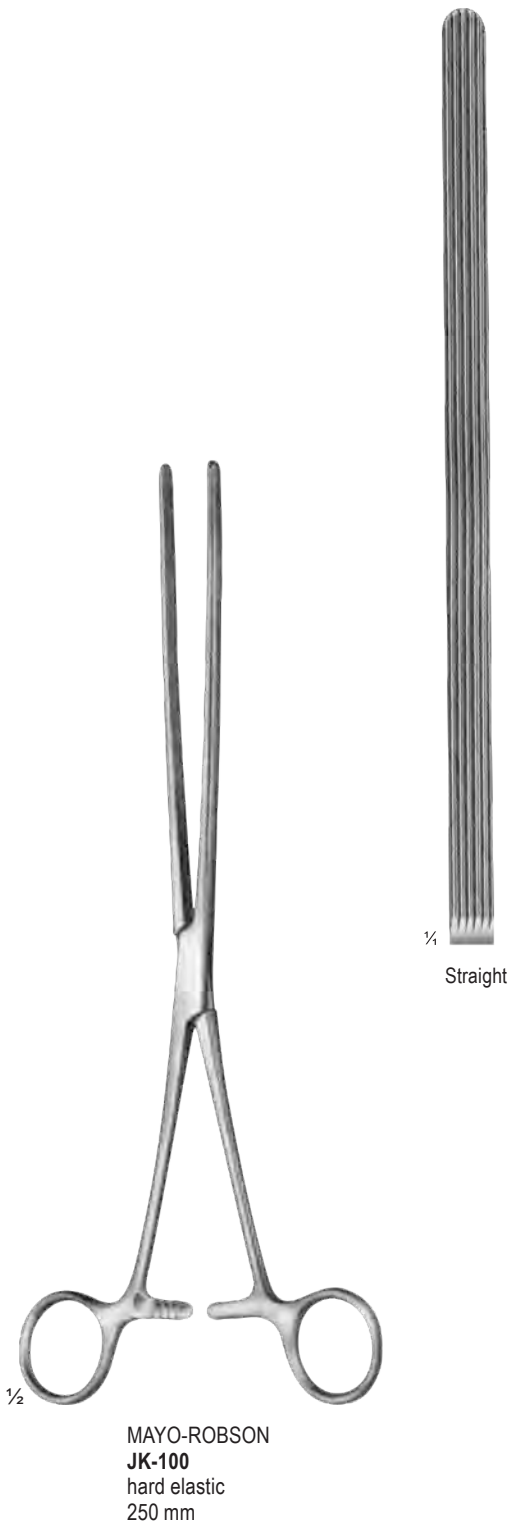





INTESTINAL CLAMPS

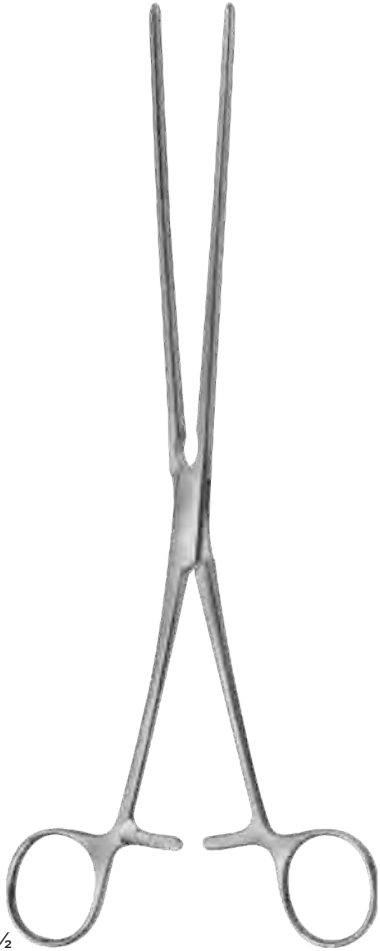

MAYO-ROBSON  
JK-102  
250 mm

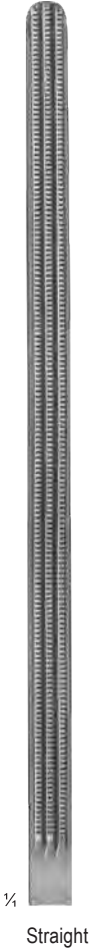

Straight

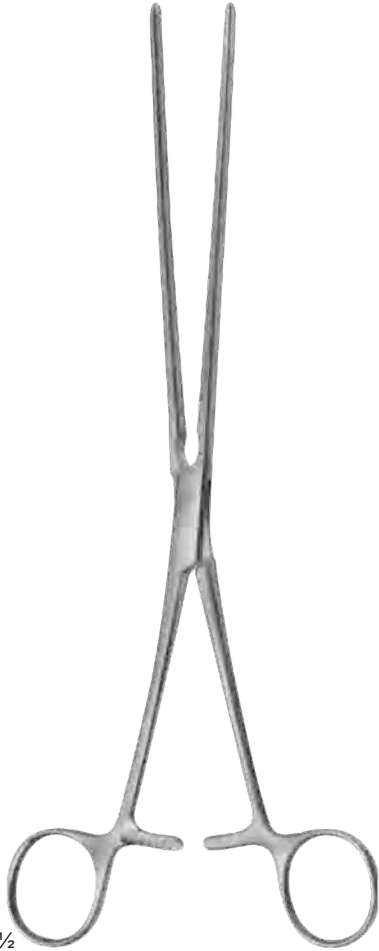

MAYO-ROBSON  
JK-103  
250 mm

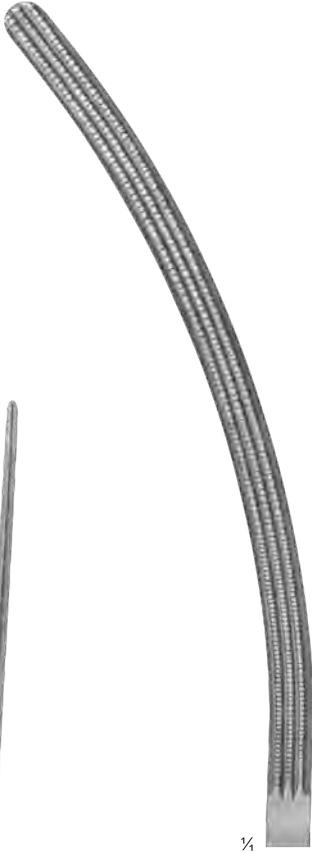

Curved

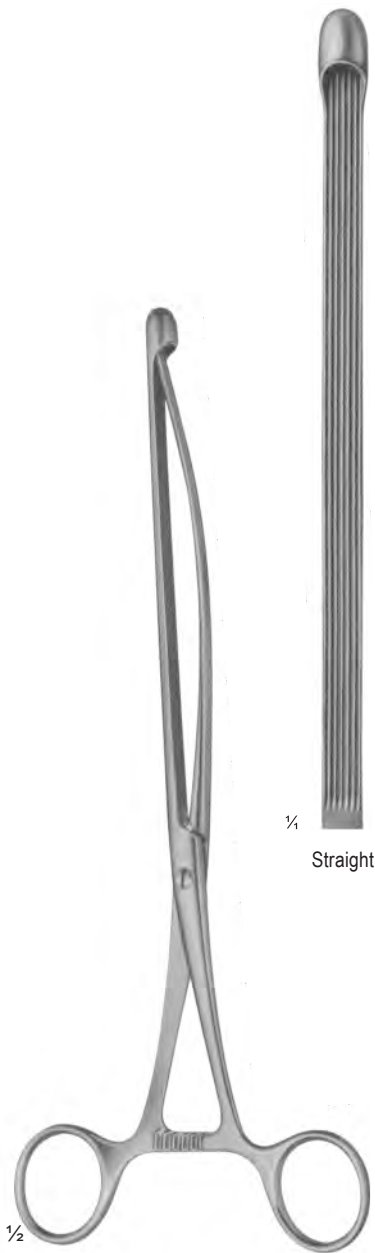

1/4  
Straight

NUSSBAUM  
**JK-104**  
with elastic blades  
250 mm



1/4  
Curved

NUSSBAUM  
**JK-105**  
with elastic blades  
250 mm

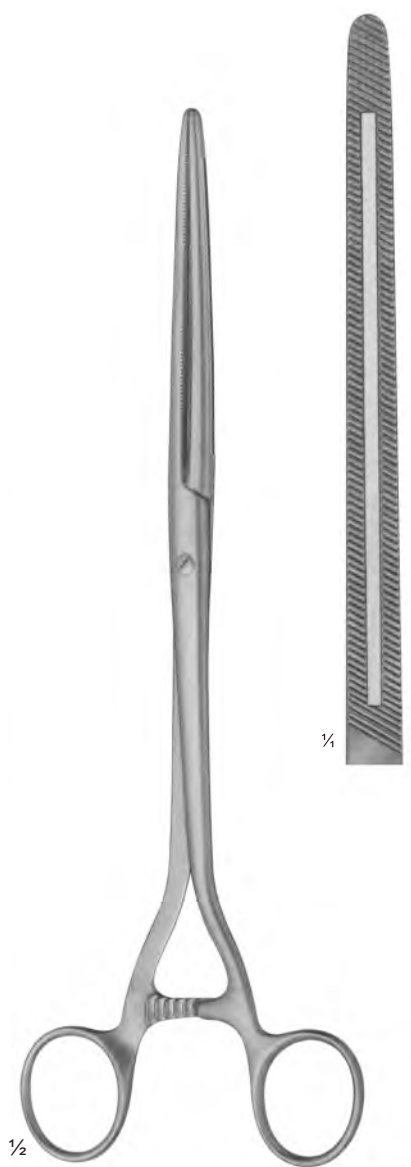

1/4

MOYNIHAN  
**JK-106**  
280 mm



SIGMOID ANASTOMOSIS FORCEPS



**PARKER-KERR  
JK-107**  
anastomosis forceps  
for colon resection  
180 mm

**DICK**  
pressure clamps  
**JK-108 - JK-111**  
**JK-108** 180 mm  
**JK-109** 255 mm  
**JK-110** 265 mm  
**JK-111** 275 mm

**LLOYD-DAVIS  
JK-112**  
315 mm





INTESTINAL CLAMPS

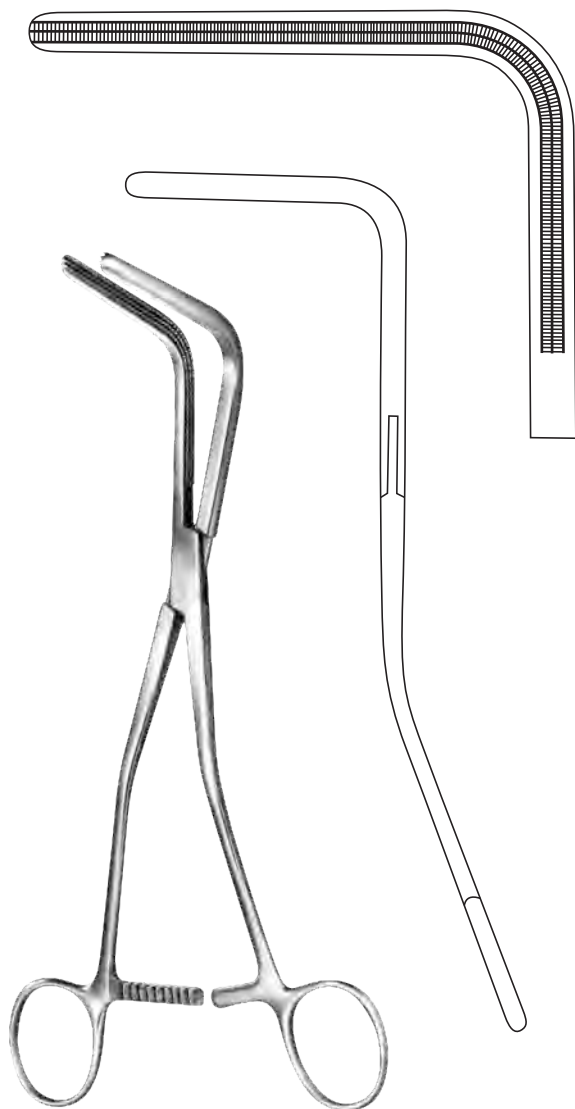

**VEIDENHEIMER  
JK-117**  
250 mm

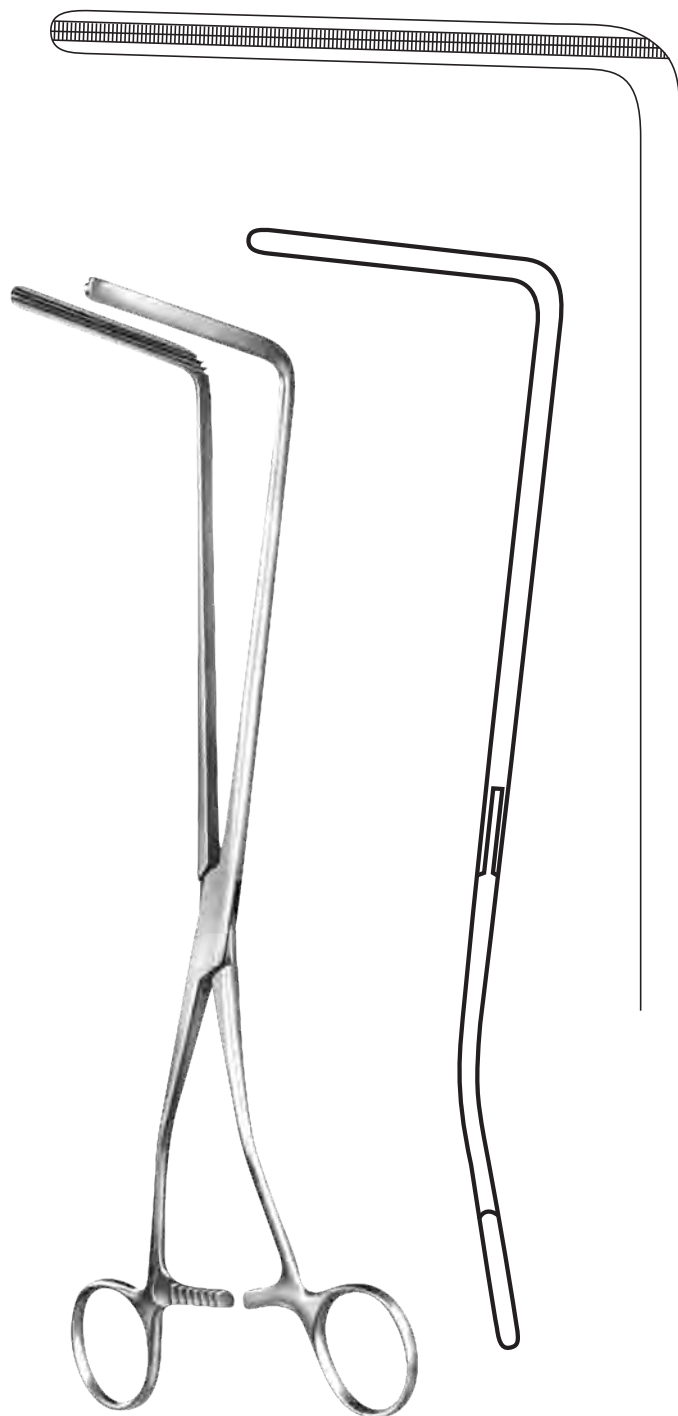

**RESANO  
JK-118**  
280 mm

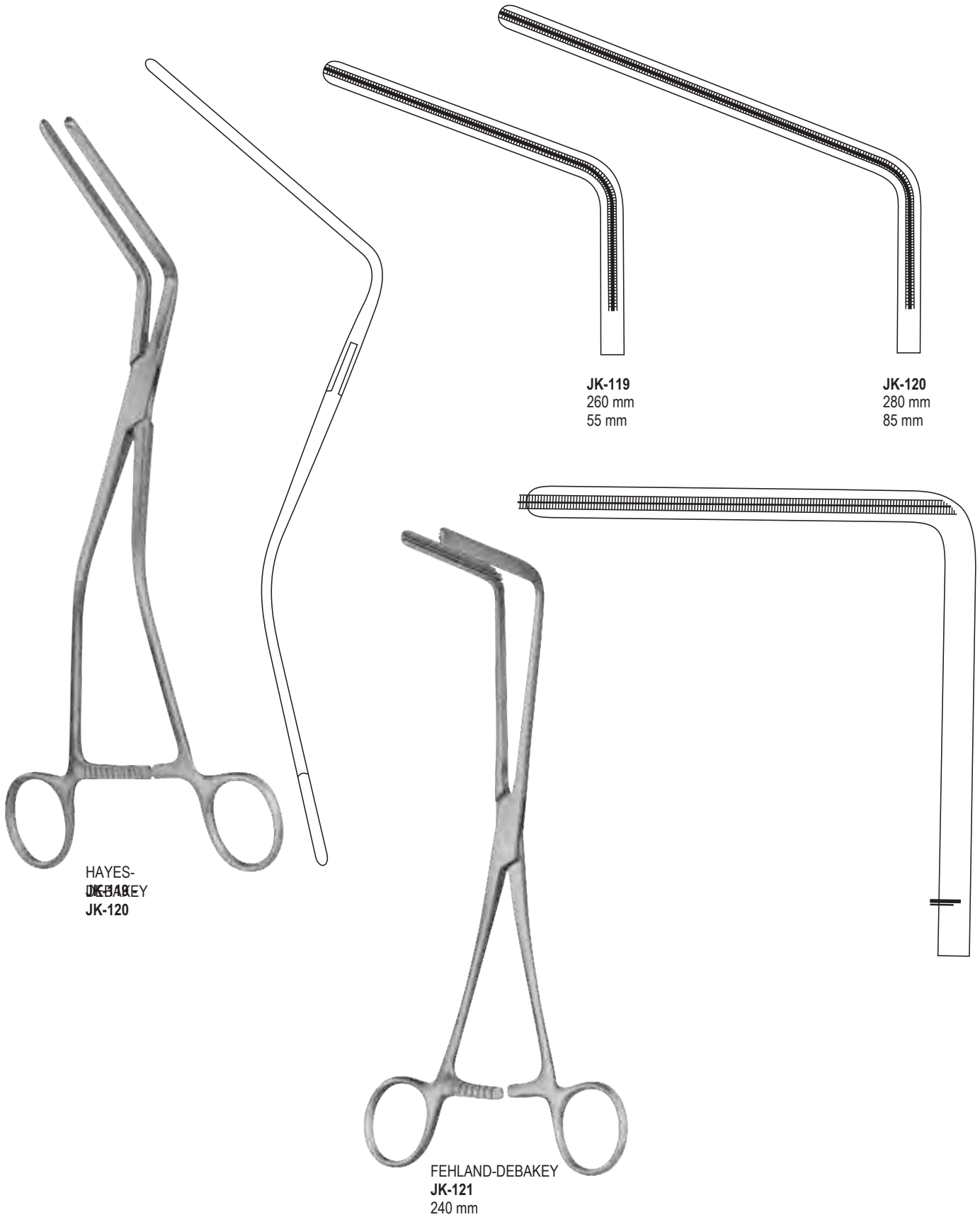

SIGMOID ANASTOMOSIS FORCEPS

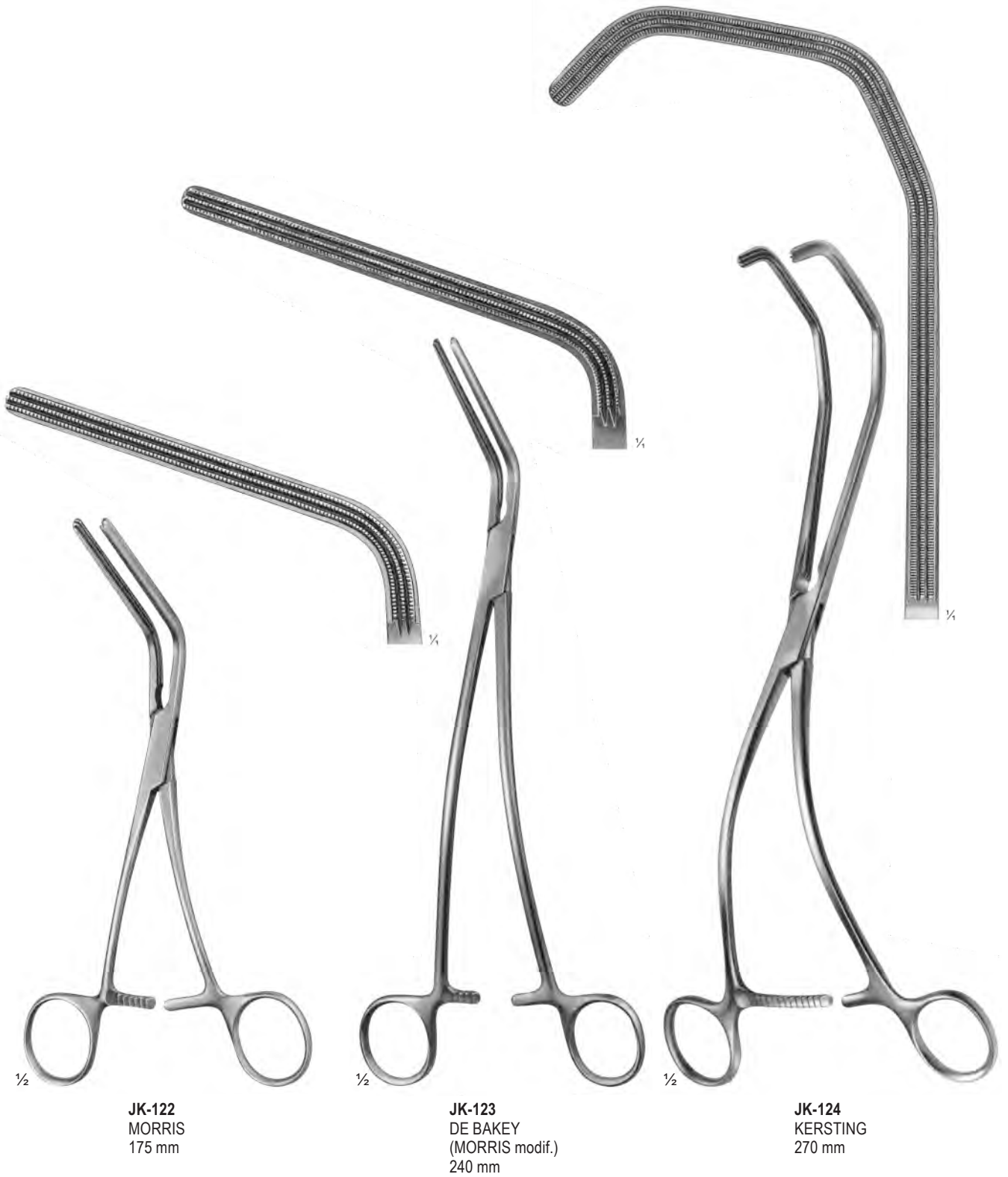

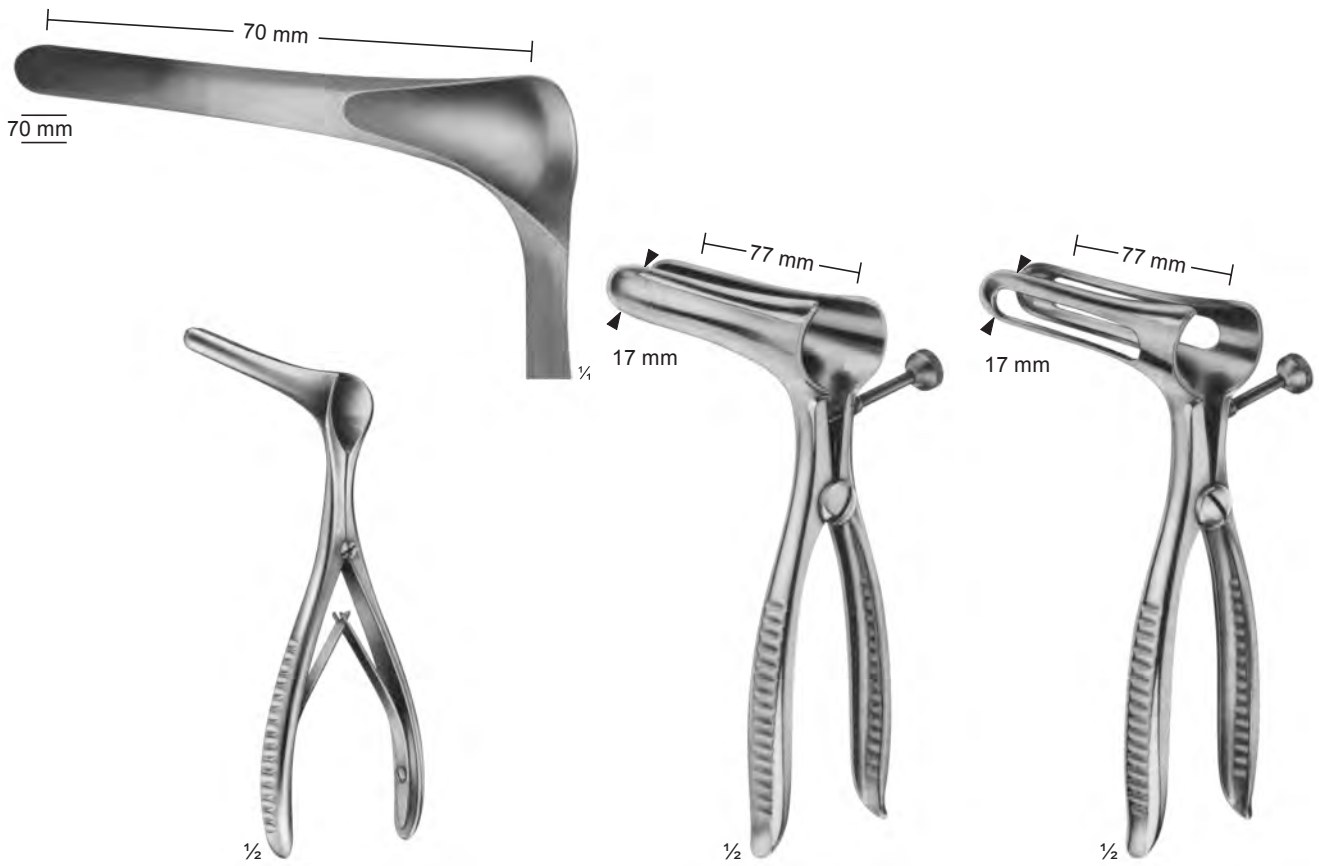

**JK-125**  
KILLIAN  
for children  
145 mm

**JK-126**  
SIMS  
160 mm

**JK-127**  
SIMS  
160 mm





INTESTINAL AND PYLORUS CLAMPS



**CZERN  
JK-128**  
220 mm



**ROSCHK  
JK-129**  
with fibre  
optic

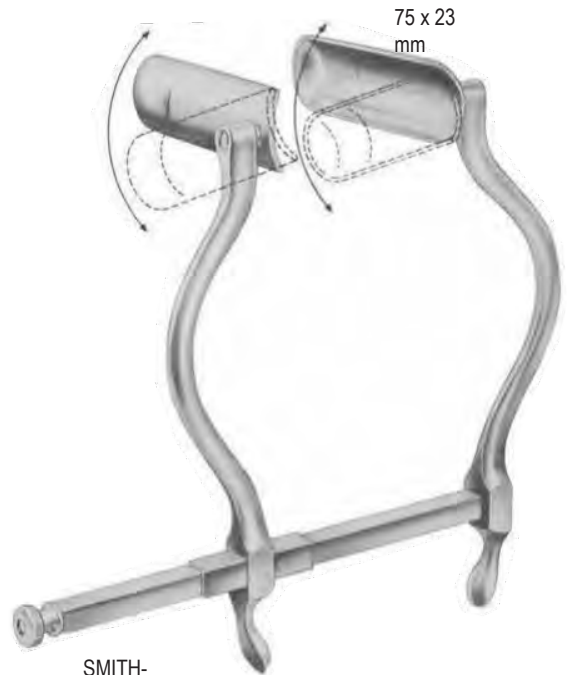

**SMITH-  
JK-130**  
150 mm



70 x 22  
mm

**BARR  
JK-131**  
170 mm

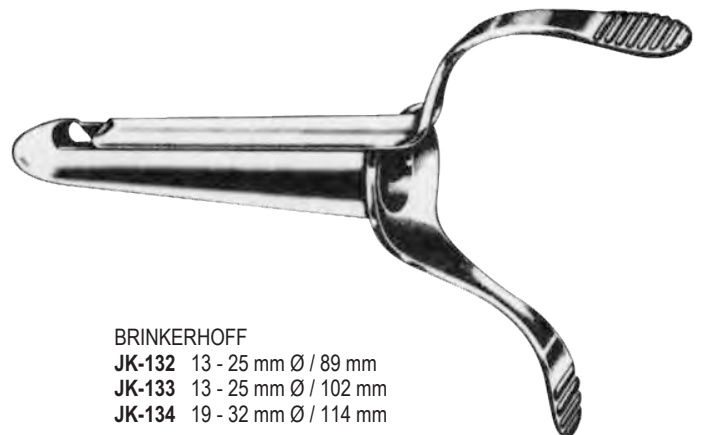

**BRINKERHOFF**  
**JK-132** 13 - 25 mm Ø / 89 mm  
**JK-133** 13 - 25 mm Ø / 102 mm  
**JK-134** 19 - 32 mm Ø / 114 mm



MCGIVNEY  
JK-135  
190 mm

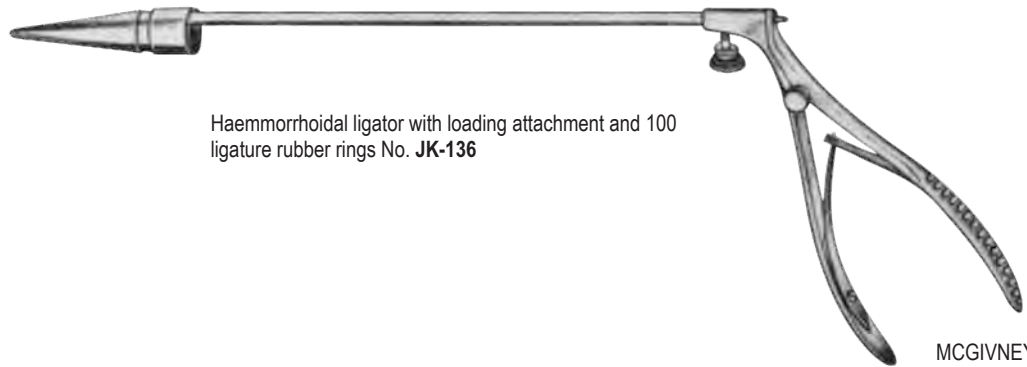

Haemorrhoidal ligator with loading attachment and 100 ligature rubber rings No. JK-136

MCGIVNEY  
JK-136

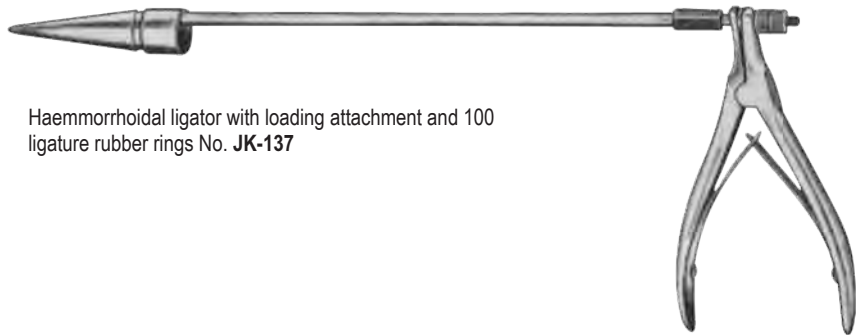

Haemorrhoidal ligator with loading attachment and 100 ligature rubber rings No. JK-137

FORD-DIXON  
JK-137

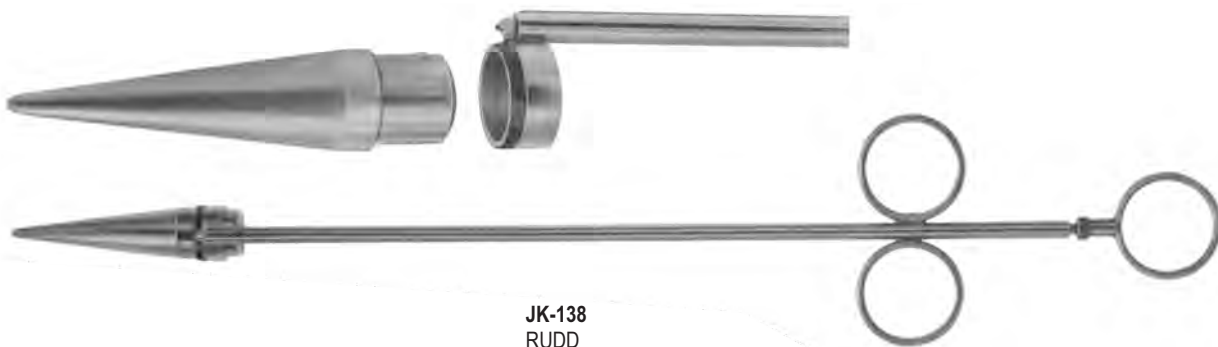

JK-138  
RUDD  
Haemorrhoidal ligator  
with loading  
attachment and 100  
ligature rubber rings  
315 mm



RUDD  
JK-139  
100 pieces



BIOPSY FORCEPS AND SWAB HOLDERS

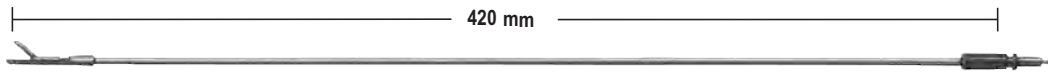

3.5 mm



1/4 JK-140

3.5 mm



1/4 JK-141

4 mm



1/4 JK-142

4 mm



1/4 JK-143



**JK-140 - JK-143**  
Handle for 265 - 266 - 267 - 268

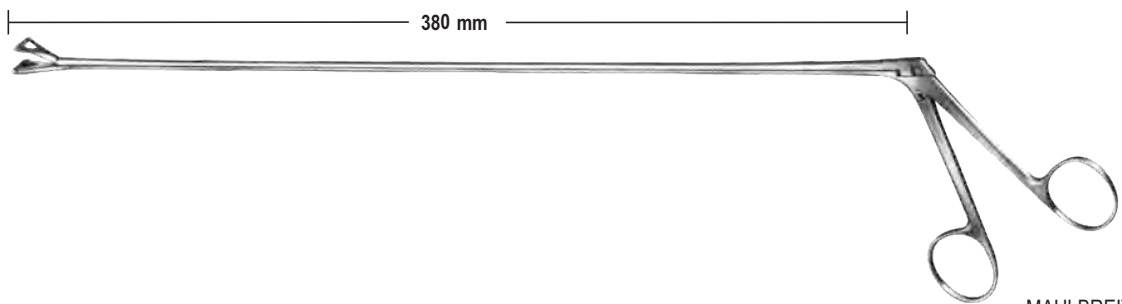

MAULBREITE  
JAW WIDTH  
**JK-144**  
380 mm  
15 mm



BUIE  
JK-145  
160 mm



PRATT  
JK-146 - JK-148  
215 mm



Fig. 1  
JK-146



Fig. 2  
JK-147



Fig. 3  
JK-148



JK-149  
12 pieces / 12 piezas



WESTON  
JK-150  
300 mm



NORWOOD  
JK-151  
300 mm



BUIE  
JK-152  
300 mm

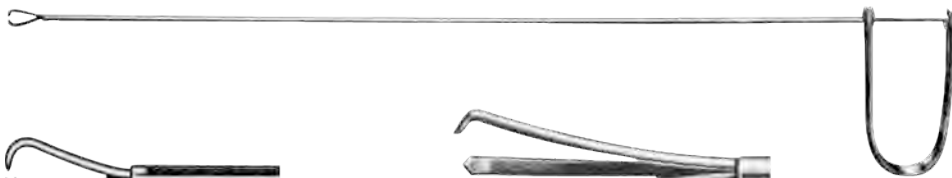

JK-153  
380 mm

JK-154  
380 mm



KATZENSTEIN  
JK-155  
90 mm



RECTAL SPECULA

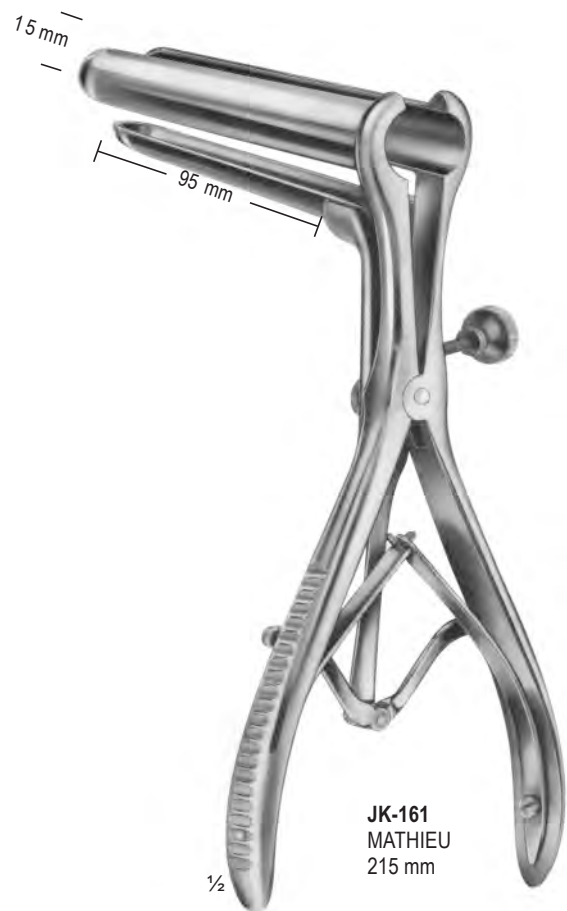
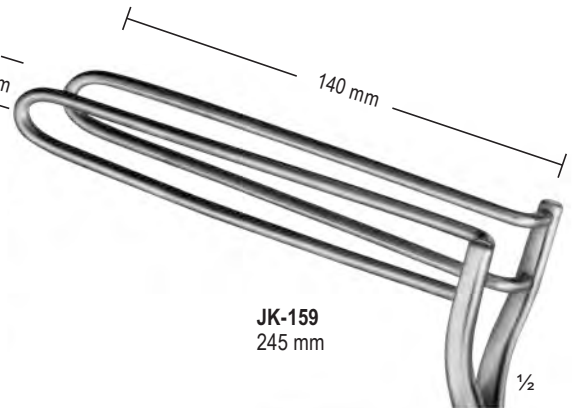
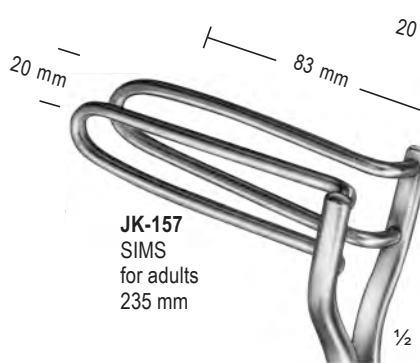
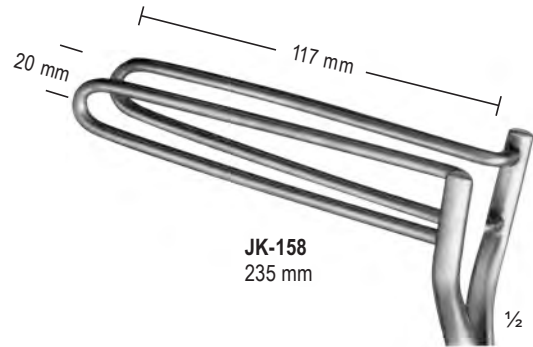
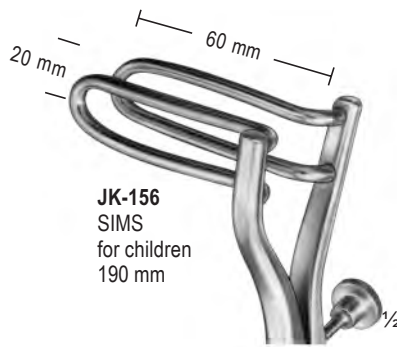

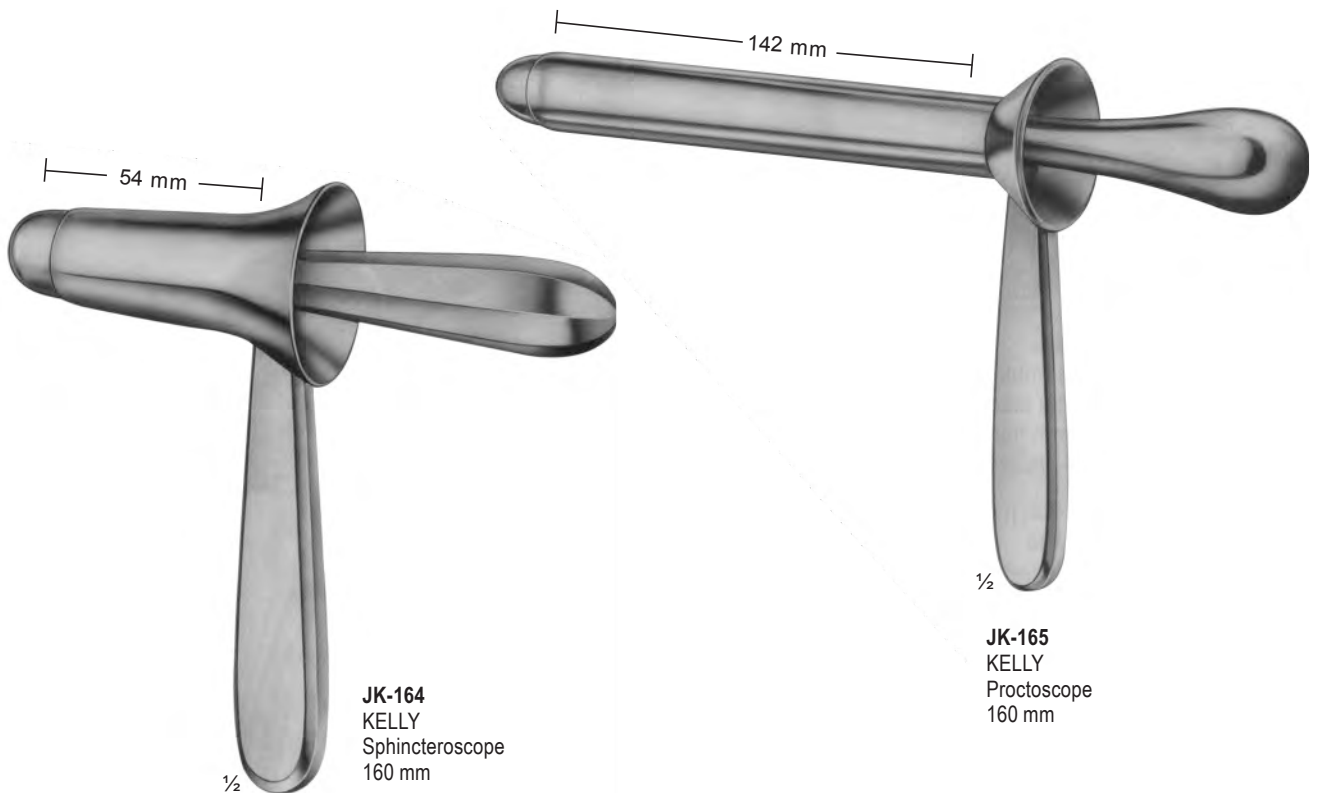
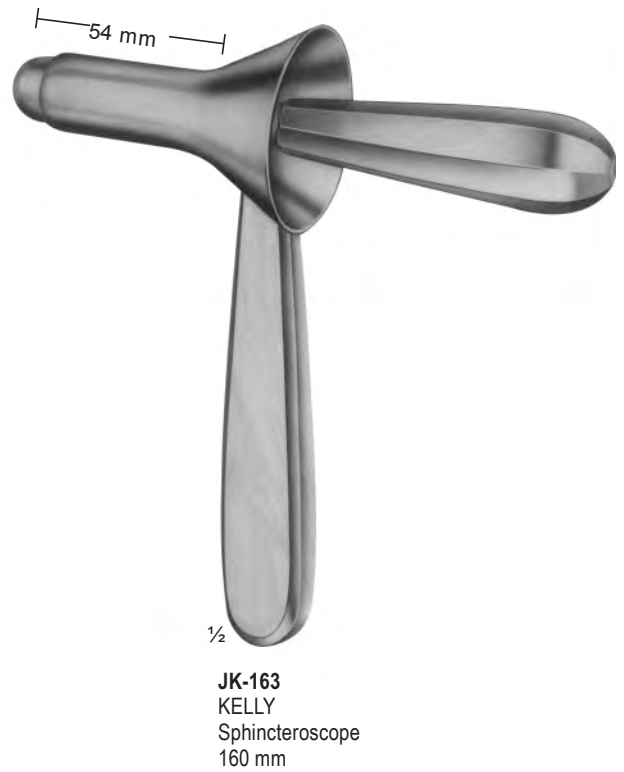



BIOPSY FORCEPS FOR RECTUM

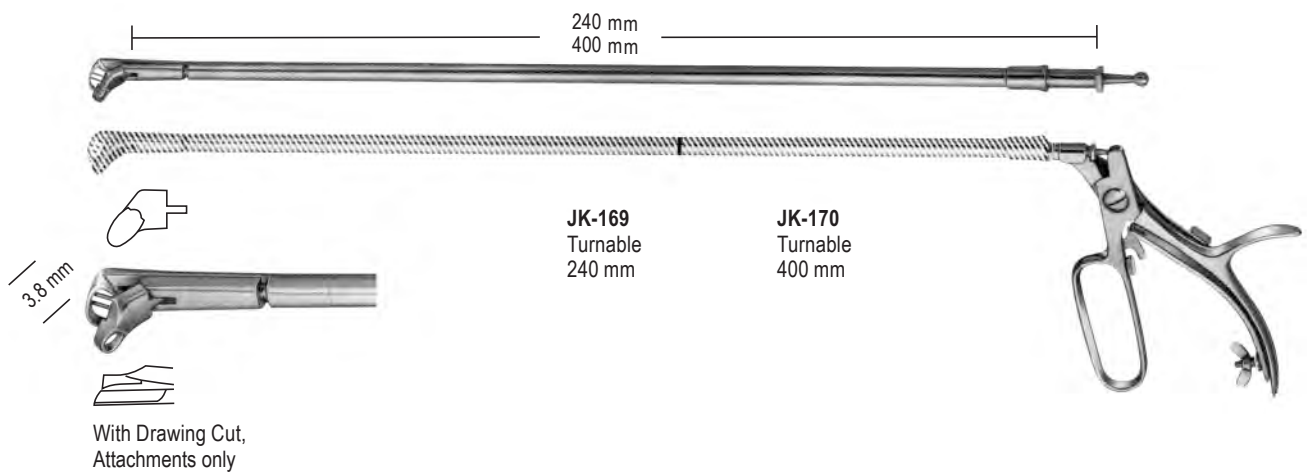
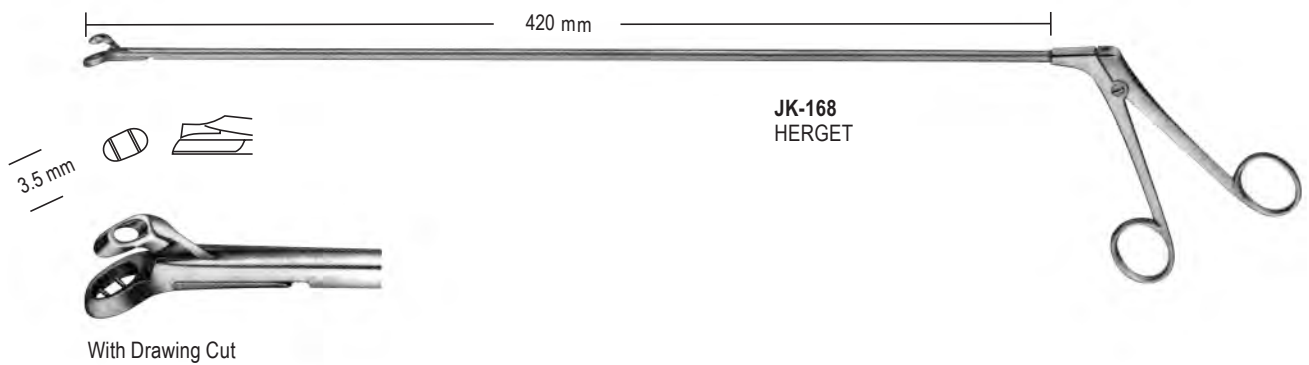
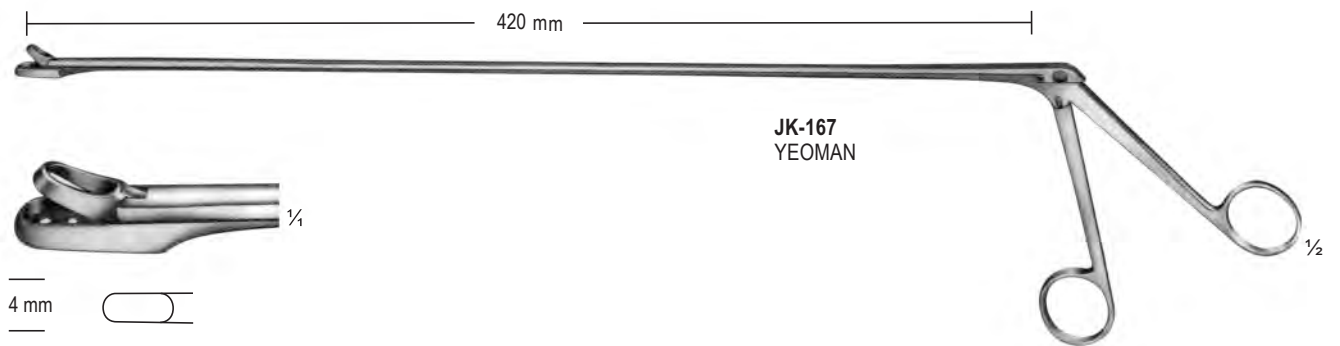
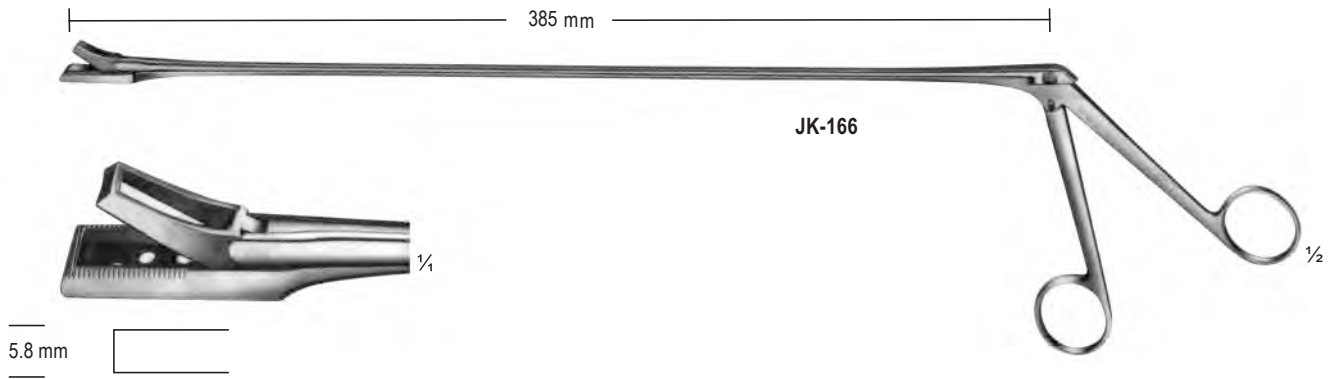



**JK-171**  
LOWER  
180 mm



**JK-172**  
LAHEY ( SWEET )  
190 mm



**JK-173**  
LAHEY  
220 mm





GALL DUCT FORCEPS



**JK-174**  
DESJARDINS  
Gall duct and cystic forceps  
210 mm

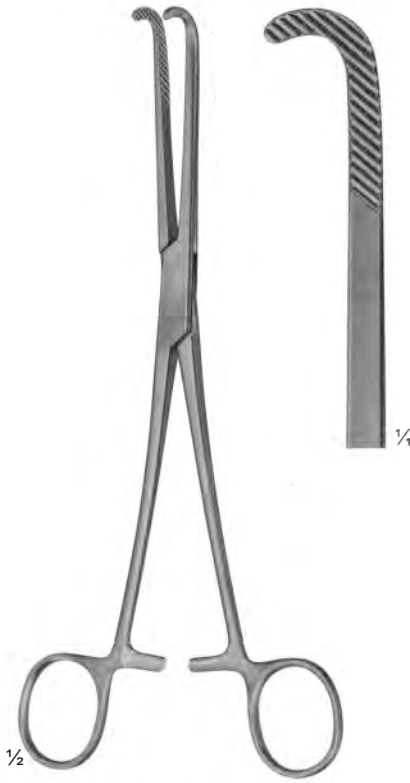

**JK-175**  
NISSEN  
Gall duct and cystic forceps  
215 mm

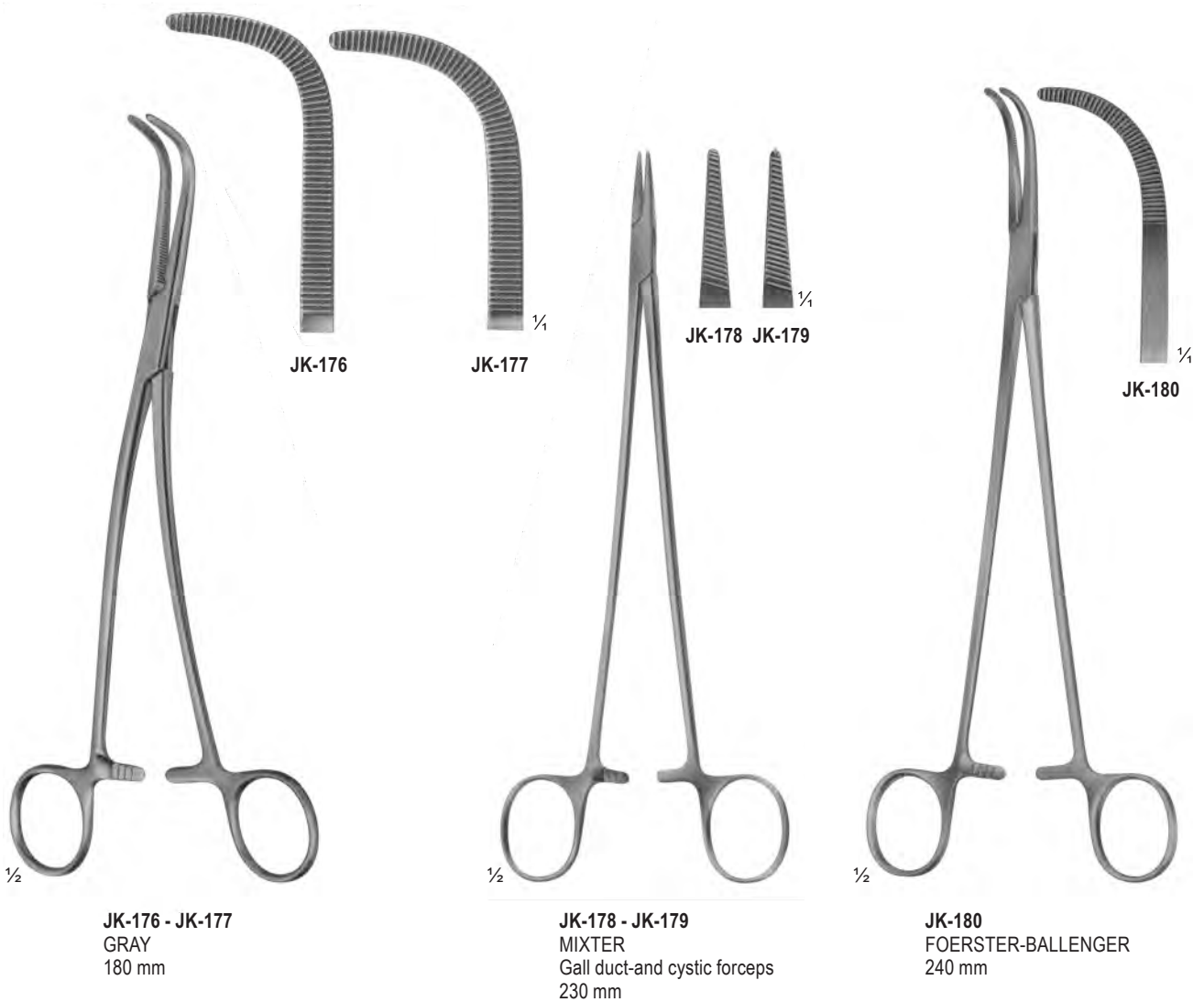



KIDNEY CLAMPS

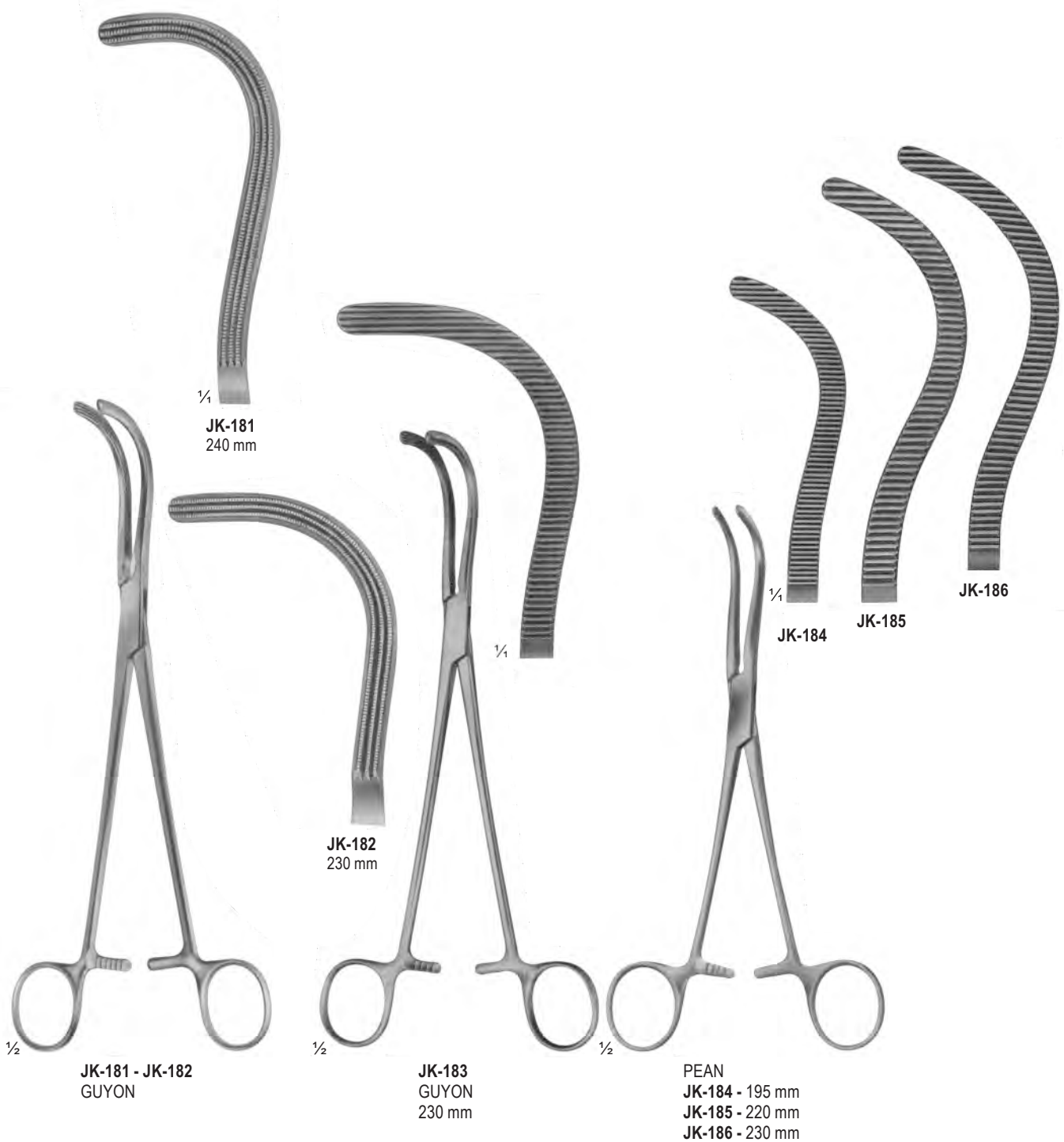

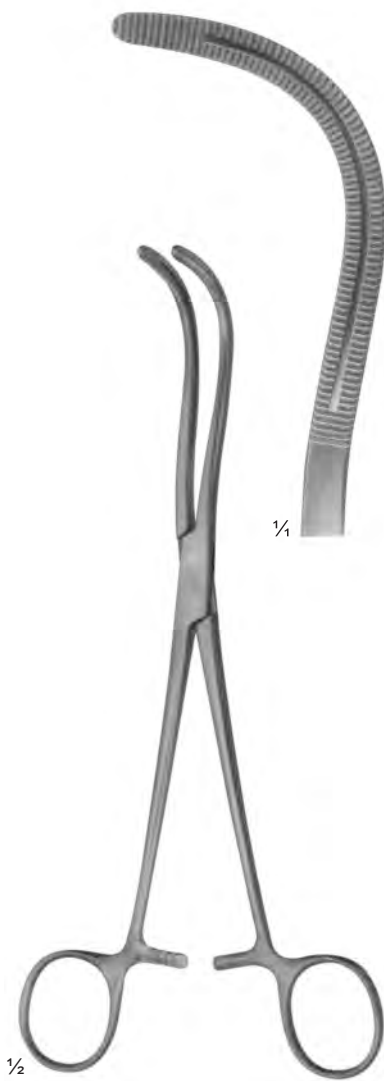

**JK-187**  
STILLE  
220 mm

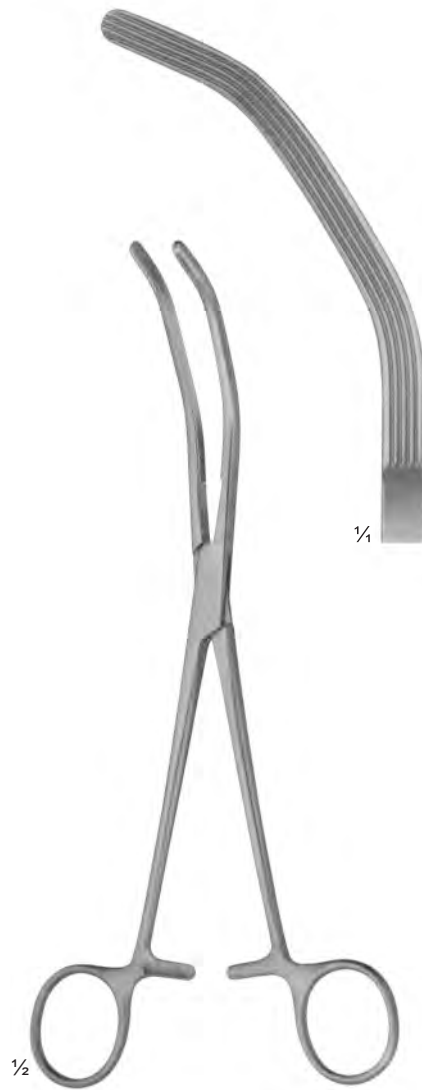

**JK-188**  
HERRICK  
225 mm

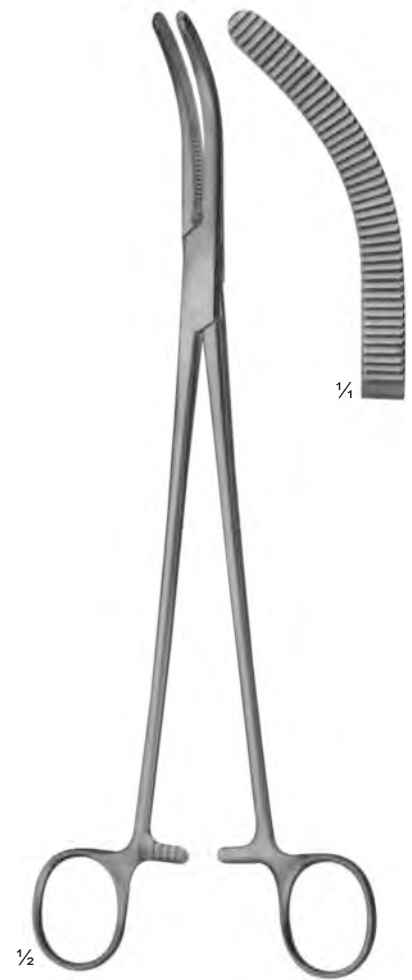

**JK-189**  
WERTHEIM  
225 mm