

Surgical Instruments Catalogue
Chirurgische Instrumente Katalog
Instruments chirurgicaux catalogue

PLASTIC SURGERY INSTRUMENTS



Manufacturer & Exporters of Surgical Instruments

darleys
S U R G I C A L C O.

Quality

Instruments

Since 1992

darleys

S U R G I C A L C O .

Quality Instruments Since 1992

Manufacturer & Exporters of Surgical Instruments

2-A Kutchery Road, Sialkot-51310 Pakistan

Tel: +92 52 426 9230 Fax: +92 52 458 6215

E-Mail: info@darleys-surgical.com

www.darleys-surgical.com

 [darleys-surgical](https://plus.google.com/darleys-surgical)  fb.com/darleyssurgical  twitter.com/darleyssurgical



cGMP CE





Quality

Instruments

Since 1992

Darleys Surgical Co.

Manufacturers & Exporters of
Surgical Instruments

Mission Statement

We, at Darleys Surgical Company strive to be a leading global manufacturer and exporters of a broad range of quality-surgical-instruments. We endeavor to provide courteous and dedicated customer service and support while supplying high-quality surgical instruments, serving a variety of disciplines, at a reasonable cost.

There is one statement that is repeated over and over again by Surgeons from across the globe when referencing Darleys Instrumentation:

“Darleys” is the best choice for excellent instruments that provide safety and the best chance for procedural success.”

COMPANY HISTORY

Since our inception in 1992, Darleys Surgical Co. has been recognized, globally, as a unique leader of innovation and design trends within the medical device industry. We have built an excellent reputation in the field by distributing a far-reaching range of surgical instruments and supplies that serve a variety of fields and disciplines.

All Darleys Instruments are masterfully hand-crafted by a team of highly-skilled and experienced craftsmen.

All of our manufacturing facilities are ISO (9001:2008, 13485:2003) FDA cGMP and CE-Mark Certified.

All of our factories, production facilities and distribution channels are wholly owned and operated by family members, eliminating the possibility of supply-chain issues or availability.

We invite you, our valued customer, to take the benefit from our superior instruments and services which, by themselves, reflect the premium quality and excellent value inherent to the Darleys Surgical name. It is our hope that you use this catalog as the primary purchasing source for all your Instrumentation needs. We extremely value our customer relations and greatly appreciate your business and loyalty to Darleys. We will tirelessly work to nurture and foster these relationships to create a life-long and loyal customer.

Thank You
Darleys Surgical Co

LIFE TIME GUARANTEE



Describe our Instruments

- ✓ *Unsurpassed*
- ✓ *Ultra*
- ✓ *Reliable*
- ✓ *Great*
- ✓ *Durable*
- ✓ *Competent*
- ✓ *High-Quality*
- ✓ *Long lasting*
- ✓ *Dependable*
- ✓ *Excellent*
- ✓ *Sensational*
- ✓ *Precise*
- ✓ *Sleek*
- ✓ *Innovative*

All Instruments are being produced under the supervision of highly experienced and skilled craftsmen.

"WE UNCONDITIONAL GUARANTEE"

- ❖ Use of best steel of proper specification in the production.
- ❖ Adequate testing in hardening/tempering.
- ❖ Accurate adjustment of ratchets/serrations of forceps, etc.
- ❖ Electrolytically polished, passivated and ultrasonically cleaned with best suitable chemicals.
- ❖ Flawless workmanship and superb finish.
- ❖ Minute inspection at every quality controlling process as per International Standard Organization specifications.
- ❖ Immediate settlement of claim against substandard quality.

This "GUARANTEE" is always maintained as all instruments are fabricated in uniform standard of samples exactly approved by the buyers.

Please ask for our MSDS (Material Safety Data Sheet) for better understanding on Best, Safe and long term usage of Darleys Instruments.

All Darleys Instruments are available in a high-polish or satin/matte finish according to individual preferences. Constructed from high-quality 300, 410, or 420 Series Stainless Steel, these devices meet or exceed all ASTM/AISI International Standards for Medical Device production. Undergoing the latest finishing techniques to prevent rusting and future corrosion, our state-of-the-art method includes, but is not limited to: surface grinding, broaching, heat treating, drilling, tapping, electronically passivating and I.D./O.D. Threading.

Plastic Surgery INSTRUMENTS

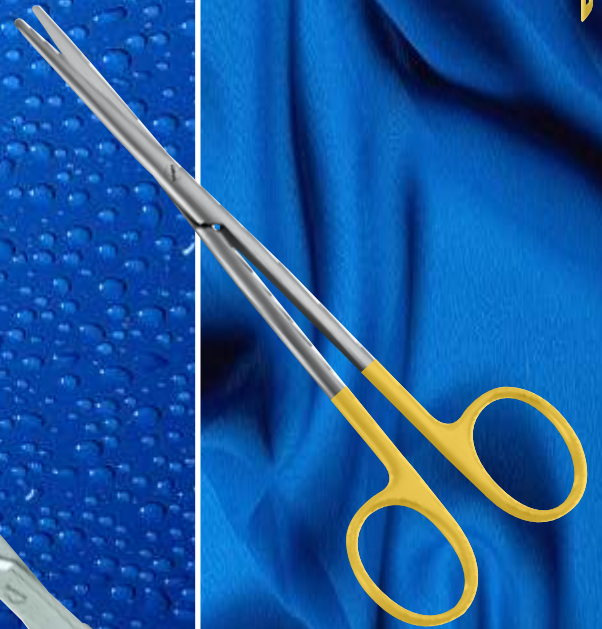
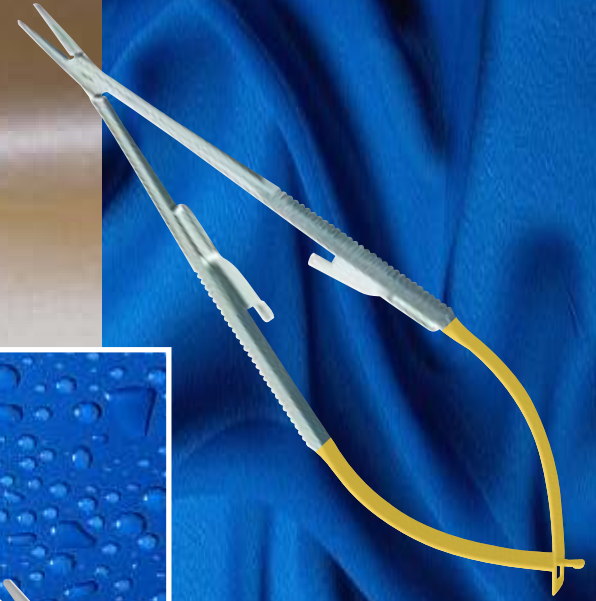

Scissors

- Gorney**
- D108-21518 18.0 cm, curved, serrated, TC
 - D108-21420 20.0 cm, straight, serrated, TC
 - D108-21520 20.0 cm, curved, serrated, TC
 - D108-21523 23.0 cm, curved, serrated, TC

- Gorney**
- D108-21220 20.0 cm, straight, serrated
 - D108-21320 20.0 cm, curved, serrated

- Freeman Gorney**
- D108-21620 20.0 cm, straight, TC
 - D108-21720 20.0 cm, curved, TC

- Freeman**
- D108-21918 18.0 cm, straight, TC
 - D108-22018 18.0 cm, curved, TC



Scissors

Aston-Face
D108-24516 17.0 cm, curved
D108-24520 20.0 cm, curved



Rees
D108-22417 17.0 cm, straight, serrated, TC
D108-22517 17.0 cm, curved, serrated, TC
D108-22419 20.0 cm, straight, serrated, TC
D108-22519 20.0 cm, curved, serrated, TC



Kaye
D108-23315 15.0 cm, curved, serrated, TC
D108-23323 23.0 cm, curved, serrated, TC



Kaye
D108-23312 11.5 cm, curved, serrated, TC



Scissors



Freeman (Kaye)
18.0 cm, curved, serrated, TC
20.0 cm, curved, serrated, TC

D108-21818
D108-21820



Davis
18.0 cm, curved,
serrated, sharp/sharp, TC

D108-24018



Castanares
16.5 cm, straight, TC

D108-24816



Goldman Fox
13.0 cm, curved, serrated, TC

D108-82313



Scissors

Par Style
very delicate
D108-20911 11.5 cm, curved, TC
D108-20914 14.5 cm, curved, TC
for serrated blades please add "WS"



Stevens Tenotomy
D108-36051 11.5 cm, straight, TC
D108-36151 11.5 cm, curved, TC



Stevens Tenotomy
D108-36011 11.0 cm, straight, sharp/sharp
D108-36111 11.0 cm, curved, sharp/sharp
D108-36211 11.0 cm, straight, blunt/blunt
D108-36311 11.0 cm, curved, blunt/blunt



Devine
fine dissecting scissors
with sharp tips,
D108-21011 11.0 cm, curved, TC



Scissors



- Kilner**
- D108-31212** 12.0 cm, straight, TC
 - D108-31412** 12.0 cm, curved, TC
 - D-5851BLHM** 12.0 cm, curved
1 blade TC
1 blade serrated



- Strabismus**
- D108-37411** 11.0 cm, straight, TC
 - D108-37511** 11.0 cm, curved, TC
 - D107-37411** 11.0 cm, straight, supercut
 - D107-37511** 11.0 cm, curved, supercut
- for serrated blades please add "WS"



- Iris**
- D108-34211** 11.5 cm, round, straight, sharp/sharp
 - D108-34311** 11.5 cm, round, curved, sharp/sharp
 - D108-34251** 11.5 cm, round, straight, sharp/sharp, TC
 - D108-34351** 11.5 cm, round, curved, sharp/sharp, TC
- for serrated blades please add "WS"



- Iris**
- D108-34011** 11.5 cm, square, straight, sharp/sharp
 - D108-34111** 11.5 cm, square, curved, sharp/sharp
 - D108-34411** 11.5 cm, square, straight, sharp/sharp, TC
 - D108-34511** 11.5 cm, square, curved, sharp/sharp, TC
- for serrated blades please add "WS"



Scissors

Joseph

- D108-30414** 14.0 cm, straight, sharp/sharp
- D108-30514** 14.0 cm, curved, sharp/sharp
- D108-30454** 14.0 cm, straight, sharp/sharp, TC
- D108-30554** 14.0 cm, curved, sharp/sharp, TC



Locklin

- D108-53916** 16.0 cm, straight, angled, sharp/sharp, TC



Shea

- D108-30612** 12.0 cm, sharp, fine, curved



Scissors

D108-40118 **Heymann**
18.0 cm, angled to side



D108-39518 **Knight**
18.0 cm, angled to side, serrated, delicate blades, TC



D108-35010 **Wilmer Converse**
10.5 cm, angled up



Scissors

D108-40213 **Fomon**
13.5 cm, lower lateral scissor,
strongly curved



D108-40354 **Fomon**
14.5 cm, angled, TC



D108-40716 **Cottle**
17.0 cm, angled, TC



Scissors

D146-26120

Caplan Septum

22.0 cm, one blade serrated,
double action, straight

D146-26122

22.0 cm, one blade serrated,
double action, curved



Metzenbaum blunt/blunt

D108-28415

14.5 cm, straight, TC

D108-28515

14.5 cm, curved, TC

D108-28418

18.0 cm, straight, TC

D108-28518

18.0 cm, curved, TC

D108-28420

20.5 cm, straight, TC

D108-28520

20.5 cm, curved, TC

D108-28423

23.0 cm, straight, TC

D108-28523

23.0 cm, curved, TC

D108-28428

28.0 cm, straight, TC

D108-28528

28.0 cm, curved, TC

for serrated blades please add "WS"



Metzenbaum, blunt/blunt

D107-28015

14.5 cm, straight, supercut

D107-28115

14.5 cm, curved, supercut

D107-28018

18.0 cm, straight, supercut

D107-28118

18.0 cm, curved, supercut

D107-28023

23.0 cm, straight, supercut

D107-28123

23.0 cm, curved, supercut



Scissors

Metzenbaum Fino blunt/blunt

- D108-28615 14.5 cm, straight, TC
- D108-28715 14.5 cm, curved, TC
- D108-28618 18.0 cm, straight, TC
- D108-28718 18.0 cm, curved, TC
- D108-28620 20.0 cm, straight, TC
- D108-28720 20.0 cm, curved, TC
- D108-28623 23.0 cm, straight, TC
- D108-28723 23.0 cm, curved, TC
- D108-28628 28.0 cm, straight, TC
- D108-28728 28.0 cm, curved, TC

for serrated blades please add "WS"



Metzenbaum sharp/sharp

- D108-27415 14.5 cm, straight, TC
- D108-27515 14.5 cm, curved, TC
- D108-27418 18.0 cm, straight, TC
- D108-27518 18.0 cm, curved, TC
- D108-27423 23.0 cm, straight, TC
- D108-27523 23.0 cm, curved, TC

for serrated blades please add "WS"



Mayo-Stille

- D108-17415 15.0 cm, straight, TC
- D108-17515 15.0 cm, curved, TC
- D108-17417 17.0 cm, straight, TC
- D108-17517 17.0 cm, curved, TC

for serrated blades please add "WS"



Scissors

D107-17017
D107-17117

Mayo-Stille
17.0 cm, straight, supercut
17.0 cm, curved, supercut



D108-19421
D108-19521

Mayo-Lexer
21.0 cm, straight, TC
21.0 cm, curved, TC



D108-11214
D108-11314

Operating sharp/blunt
14.5 cm, straight, round, TC
14.5 cm, curved, round, TC



Scissors

Operating sharp/sharp
D108-12214 14.5 cm, straight, round, TC
D108-12314 14.5 cm, curved, round, TC



Operating blunt/blunt
D108-10614 14.5 cm, straight, round, TC
D108-10714 14.5 cm, curved, round, TC



Universal Wire Scissors
D108-83512 12.0 cm, serrated, TC

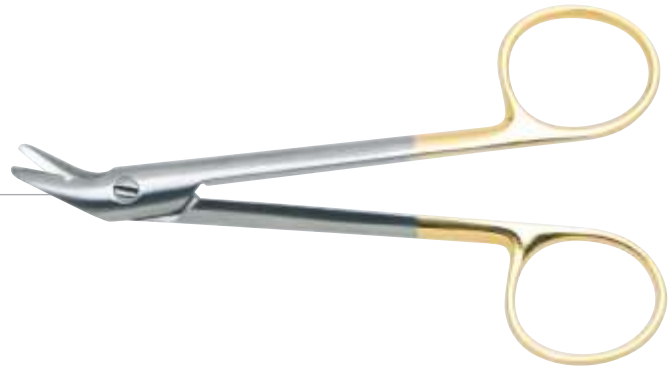

Stevens Tenotomy Scissors
D108-36509 9.5 cm, curved, sharp/sharp, ribbon type
D108-36512 12.0 cm, curved, sharp/sharp, ribbon type



Scissors

- Iris**
- D108-32209 9.5 cm, straight, sharp/sharp, ribbon type
 - D108-32309 9.5 cm, curved, sharp/sharp, ribbon type
 - D108-32610 10.5 cm, straight, sharp/sharp, ribbon type
 - D108-32710 10.5 cm, curved, sharp/sharp, ribbon type

- Littler**
- D108-20512 12.0 cm, curved, tips with eye for suture
 - D108-20514 14.0 cm, curved, tips with eye for suture

- Spencer**
- D108-80209 9.0 cm, straight, ligature scissor

- Knowles Bandage**
- D108-93114 14.0 cm, angled, serrated



Scissors

- Lister Bandage**
D108-90114 14.0 cm, angled
D108-90118 18.0 cm, angled



- Freeman Kaye**
D108-21617 17.0 cm, curved



- Micro Scissors**
 spring scissors with round handle, blade 14 mm
- D109-20615** 15.0 cm, straight
 - D109-20815** 15.0 cm, straight, blades serrated
 - D109-20715** 15.0 cm, curved
 - D109-20915** 15.0 cm, curved, blades serrated
 - D109-20618** 18.0 cm, straight
 - D109-20818** 18.0 cm, straight, blades serrated
 - D109-20718** 18.0 cm, curved
 - D109-20918** 18.0 cm, curved, blades serrated



Needle Holders

D124-12811
D124-12913

Webster
11.5 cm, smooth
13.0 cm, smooth, TC

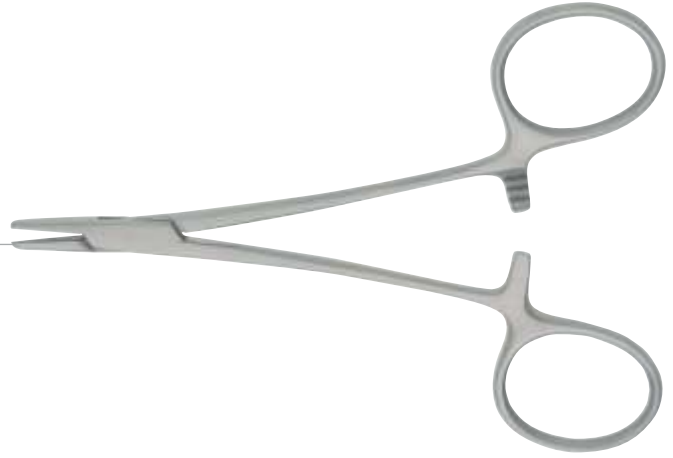

D124-13413
D124-14413

Halsey
13.0 cm, smooth, TC
13.0 cm, cross serrated, TC



D124-14011
D124-14013

Par
11.5 cm, cross serrated, TC
13.0 cm, cross serrated, TC



Needle Holders

D124-11012 **Derf** 12.0 cm, serrated
D124-11412 12.0 cm, cross serrated, TC



D124-14713 **Neivert** 13.0 cm, cross serrated, TC



D124-21815 **Swedish** 15.5 cm, cross serrated, TC

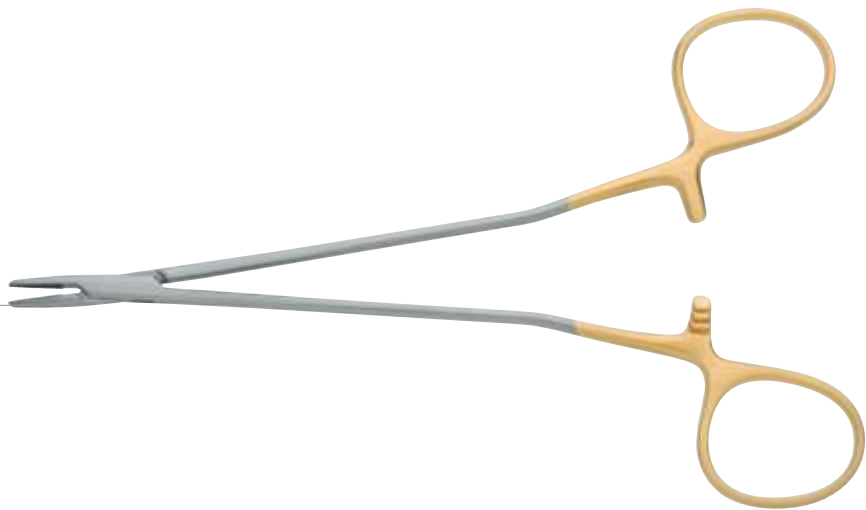



Needle Holders

Ryder

- D124-22413** 13.0 cm, cross serrated, TC
- D124-22415** 15.0 cm, cross serrated, TC
- D124-22418** 18.0 cm, cross serrated, TC



Micro Ryder

- D124-22613** 13.0 cm, cross serrated, TC
- D124-22615** 15.0 cm, cross serrated, TC
- D124-22618** 18.0 cm, cross serrated, TC

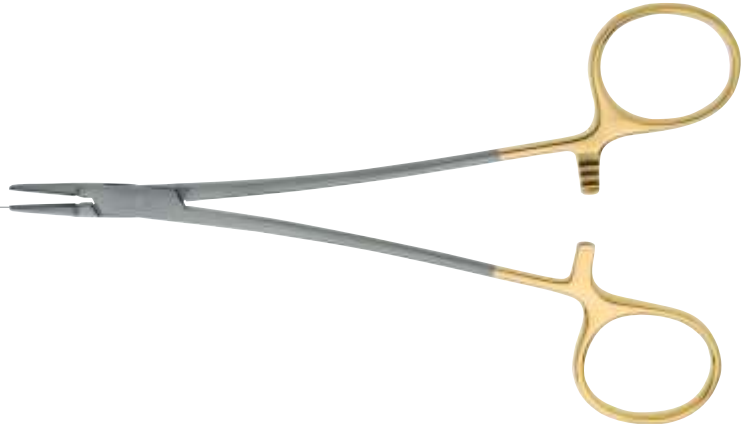

Euphrate-Pasque

extremely delicate

- D124-23814** 14.0 cm, cross serrated, TC
- D124-23815** 15.0 cm, cross serrated, TC
- D124-23818** 18.0 cm, cross serrated, TC
- D124-23820** 20.0 cm, cross serrated, TC

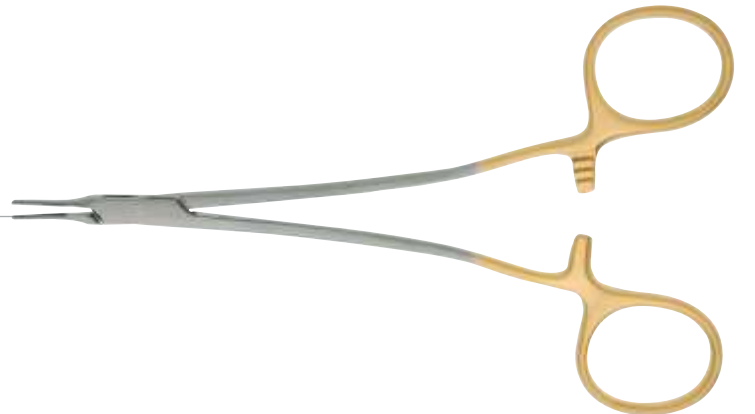

Needle Holders

Micro-Vascular

- D124-23415** 15.0 cm, cross serrated, TC
- D124-23418** 18.0 cm, cross serrated, TC

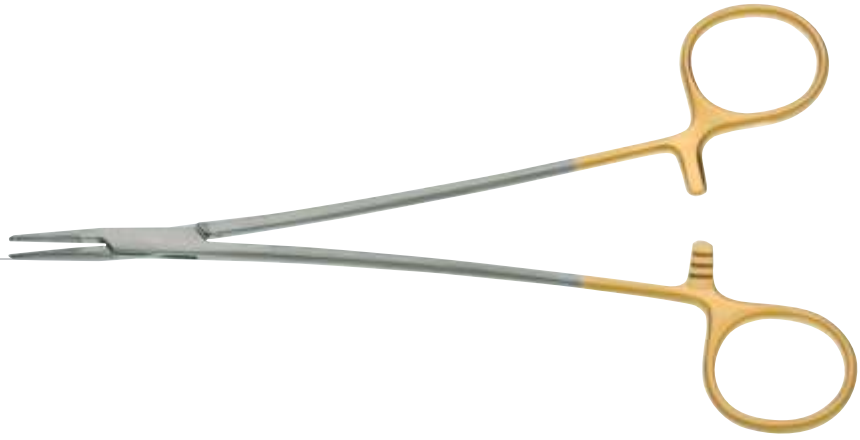

Crile-Wood

- D124-16215** 15.0 cm, smooth, TC
- D124-16415** 15.0 cm, cross serrated, TC
- D124-16418** 18.0 cm, cross serrated, TC
- D124-16420** 20.0 cm, cross serrated, TC
- D124-16423** 23.0 cm, cross serrated, TC

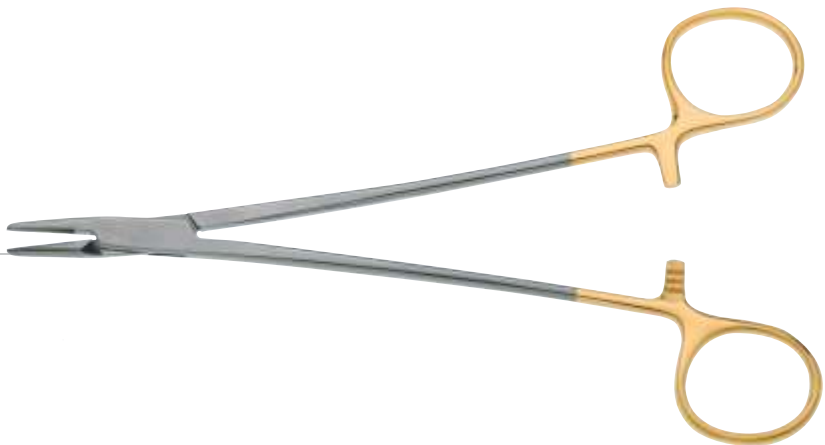

Lemmon

- D124-24814** 14.0 cm, cross serrated, TC
- D124-24817** 17.0 cm, cross serrated, TC
- D124-24819** 19.0 cm, cross serrated, TC

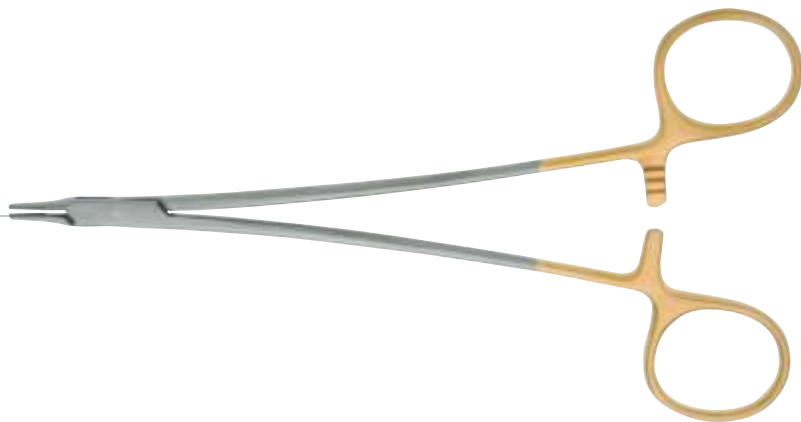

Needle Holders

- Baumgartner**
D124-15412 12.5 cm, cross serrated, TC
D124-15414 14.0 cm, cross serrated, TC



- Mayo Hegar**
D124-18414 14.0 cm, cross serrated, TC
D124-18416 16.0 cm, cross serrated, TC
D124-18418 18.0 cm, cross serrated, TC
D124-18420 20.0 cm, cross serrated, TC



- Wire Twister**
D133-60011 13.0 cm, round jaw, cross serrated, TC
D133-60001 16.0 cm, blunt jaw, cross serrated, TC
D133-60012 18.0 cm, round jaw, cross serrated, TC
D133-60002 18.0 cm, blunt jaw, cross serrated, TC

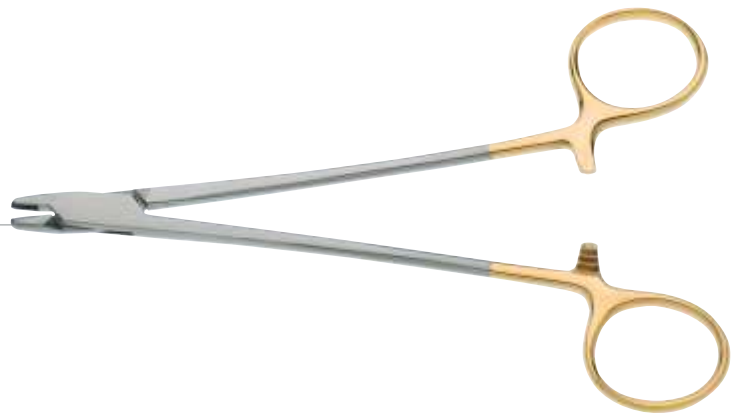

Needle Holders

D133-53901
D133-53902
D133-53903

Corwin Wire Twister

16.0 cm, long round jaw, cross serrated, TC
16.0 cm, blunt jaw, cross serrated, TC
16.0 cm, round jaw, cross serrated, TC



D124-41414
D124-41418

Olsen Hegar

needleholder/scissors combination
14.0 cm, cross serrated, TC
18.0 cm, cross serrated, TC



D124-43416

Gillies

needleholder/scissors combination
16.0 cm, cross serrated, curved, TC



Needle Holders

- Barraquer Micro**
with round handle, without lock, tip 0.8 × 1.2 mm
- D124-64014** 14.0 cm, straight, diamond dusted
 - D124-64114** 14.0 cm, curved, diamond dusted
 - D124-64015** 15.0 cm, straight, diamond dusted
 - D124-64115** 15.0 cm, curved, diamond dusted
 - D124-64018** 18.0 cm, straight, diamond dusted
 - D124-64118** 18.0 cm, curved, diamond dusted



- Barraquer Micro**
with round handle, with lock, tip 0.8 × 1.2 mm
- D124-64214** 14.0 cm, straight, diamond dusted
 - D124-64314** 14.0 cm, curved, diamond dusted
 - D124-64215** 15.0 cm, straight, diamond dusted
 - D124-64315** 15.0 cm, curved, diamond dusted
 - D124-64218** 18.0 cm, straight, diamond dusted
 - D124-64318** 18.0 cm, curved, diamond dusted



Needle Holders

Barraquer Delicate

with round handle, without lock, tip 1.2 × 1.8 mm

- D124-63414** 14.0 cm,
cross serrated, straight, TC
- D124-63514** 14.0 cm,
cross serrated, curved, TC
- D124-63415** 15.0 cm,
cross serrated, straight, TC
- D124-63515** 15.0 cm,
cross serrated, curved, TC
- D124-63418** 18.0 cm,
cross serrated, straight, TC
- D124-63518** 18.0 cm,
cross serrated, curved, TC



Barraquer Micro

with round handle, without lock, tip 0.8 × 1.2 mm

- D124-63614** 14.0 cm,
cross serrated, straight, TC
- D124-63714** 14.0 cm,
cross serrated, curved, TC
- D124-63615** 15.0 cm,
cross serrated, straight, TC
- D124-63715** 15.0 cm,
cross serrated, curved, TC
- D124-63618** 18.0 cm,
cross serrated, straight, TC
- D124-63718** 18.0 cm,
cross serrated, curved, TC



Needle Holders

- Barraquer Delicate**
with round handle, with lock, tip 1.2 × 1.8 mm
- D124-66714** 14.0 cm, cross serrated, straight, TC
 - D124-66614** 14.0 cm, cross serrated, curved, TC
 - D124-66715** 15.0 cm, cross serrated, straight, TC
 - D124-66615** 15.0 cm, cross serrated, curved, TC
 - D124-66718** 18.0 cm, cross serrated, straight, TC
 - D124-66618** 18.0 cm, cross serrated, curved, TC



- Barraquer Micro**
with round handle, with lock, tip 0.8 × 1.2 mm
- D124-66814** 14.0 cm, cross serrated, straight, TC
 - D124-66914** 14.0 cm, cross serrated, curved, TC
 - D124-66815** 15.0 cm, cross serrated, straight, TC
 - D124-66915** 15.0 cm, cross serrated, curved, TC
 - D124-66818** 18.0 cm, cross serrated, straight, TC
 - D124-66918** 18.0 cm, cross serrated, curved, TC



- Castroviejo**
with fat handle, with lock
- D124-67813** 14.0 cm, smooth, straight, TC
 - D124-67814** 14.0 cm, cross serrated, straight, TC
 - D124-67513** 14.0 cm, smooth, curved, TC
 - D124-67514** 14.0 cm, cross serrated, curved, TC
 - D124-67817** 18.0 cm, smooth, straight, TC
 - D124-67819** 18.0 cm, cross serrated, straight, TC
 - D124-67517** 18.0 cm, smooth, curved, TC
 - D124-67518** 18.0 cm, cross serrated, curved, TC



Needle Holders

Castroviejo

with fat handle, without lock

- D124-69614** 14.0 cm, straight, diamond dusted
- D124-69714** 14.0 cm, curved, diamond dusted
- D124-69618** 18.0 cm, straight, diamond dusted
- D124-69718** 18.0 cm, curved, diamond dusted



Castroviejo

with fat handle, with lock

- D124-69814** 14.0 cm, straight, diamond dusted
- D124-69914** 14.0 cm, curved, diamond dusted
- D124-69818** 18.0 cm, straight, diamond dusted
- D124-69918** 18.0 cm, curved, diamond dusted



Castroviejo Ryder

with fat handle, with lock

- D124-70214** 14.0 cm, cross serrated, straight, TC
- D124-70218** 18.0 cm, cross serrated, straight, TC



Barraquer

with round handle, with inserted jaws 0.75mm

- D124-65712** 12.0 cm, straight, without lock, smooth
- D124-65912** 12.0 cm, curved, without lock, smooth







Forceps / Thumb

- | | | |
|--|---|--|
| <p>D110-17412 D110-17415</p> | <p>Adson 12.0 cm, cross serrated, TC 15.0 cm, cross serrated, TC</p> |  |
| <p>D110-20412</p> | <p>Adson 12.0 cm, serrated, Titanium</p> |  |
| <p>D110-17012 D110-17612</p> | <p>Adson 12.0 cm, serrated 12.0 cm, serrated, Micro</p> |  |
| <p>D110-17912</p> | <p>Adson Dressing 12.0 cm, cross serrated</p> |  |
| <p>D110-17512 D110-17515</p> | <p>Adson 12.0 cm, cross serrated, 1x2 teeth, TC 15.0 cm, cross serrated, 1x2 teeth, TC</p> |  |
| <p>D110-20512</p> | <p>Adson 12.0 cm, smooth, 1x2 teeth, Titanium</p> |  |
| <p>D110-18012</p> | <p>Adson Tissue 12.0 cm, smooth, 1x2 teeth</p> |  |



Forceps / Thumb

- | | | | |
|--|---|--|---|
| <p>D110-18512</p> | <p>Adson Tubiana 12.0 cm, 1x2 teeth, with platform 1 mm</p> |  | 8 |
| <p>D110-18802 D110-18805</p> | <p>Brown-Adson 12.0 cm, cross serrated, Brown teeth, TC 15.0 cm, cross serrated, Brown teeth, TC</p> |  | 7 |
| <p>D110-18812</p> | <p>Brown-Adson 12.0 cm, Brown teeth</p> |  | 6 |
| <p>D110-17312 D110-17315</p> | <p>Adson Micro 12.0 cm, cross serrated, 1x2 teeth, TC 15.0 cm, cross serrated, 1x2 teeth, TC</p> |  | 5 |
| <p>D110-17452</p> | <p>Par 12.0 cm, cross serrated, TC</p> |  | 3 |
| <p>D110-16912 D110-17455</p> | <p>Adson Delicate 12.0 cm, smooth, TC 15.0 cm, cross serrated, TC</p> |  | 2 |
| <p>D110-18612D</p> | <p>Gorney-Adson 12.0 cm, 1x2 teeth, with platform, diamond dusted</p> |  | 1 |



Forceps / Thumb

- Castroviejo**
- D143-14915 10,5 cm, 1.5 mm tip, 1x2 teeth, with platform
 - D143-14903 10,5 cm, 3 mm tip, 1x2 teeth, with platform
 - D143-14905 10,5 cm, 5 mm tip, 1x2 teeth, with platform
 - D143-14909 10,5 cm, 9 mm tip, 1x2 teeth, with platform



- Castroviejo-Brown**
- D110-18851 11.0 cm, brown teeth



- Graefe Iris**
- D142-82010 10.0 cm, smooth, 1x2 teeth



- Graefe Iris**
- D142-81010 10.0 cm, serrated



- Julian Suture**
- D142-82511 11.0 cm, smooth, curved



- Adson-Graefe**
- D110-20012 12.0 cm, multi-toothed



Forceps / Thumb

Bishop-Harmon

- D142-94004** 8.5 cm, smooth, 1x2 teeth, fine
- D142-94006** 8.5 cm, smooth, 1x2 teeth



Green Fixation

- D143-07605** 10.0 cm, 5 mm tip, without lock
- D143-07610** 10.0 cm, 10 mm tip, without lock
- D143-07612** 10.0 cm, 12 mm tip, without lock
- D143-07805** 10.0 cm, 5 mm tip, with lock
- D143-07810** 10.0 cm, 10 mm tip, with lock
- D143-07812** 10.0 cm, 12 mm tip, with lock



Semken

- D110-26915** 15.0 cm, cross-serrated, 1x2 teeth, TC



McIndoe Dissecting

- D110-25815** 15.0 cm, serrated



Gillies Dissecting

- D110-27215** 15.0 cm, cross serrated, 1x2 teeth



General

- D110-11115** 15.0 cm, cross serrated, TC



Forceps / Thumb

- D110-22417** **Cushing**
17.0 cm, cross serrated, TC
- D110-22217** **Cushing**
17.0 cm, serrated, Titanium
- D110-22517** **Cushing**
17.0 cm, angled, cross serrated, TC
- D110-22618** **Taylor Cushing**
18.5 cm, cross serrated, bayonet, TC
- D110-25317** **Bonney**
17.5 cm, cross serrated, 1x2 teeth, TC
- D110-11618** **Potts-Smith**
18.0 cm, cross serrated, TC
D110-11621 21.0 cm, cross serrated, TC
D110-11625 25.0 cm, cross serrated, TC



Forceps / Thumb

- Gerald**
- D110-30618** 18.0 cm, cross serrated, 1x2 teeth, TC
 - D110-30118** 18.0 cm, cross serrated, TC



- Skinner**
- D110-32323** 23.0 cm, cross serrated, 1x2 teeth, TC



- DeBakey Titanium**
- D111-30015** 15.0 cm, 1.5 mm tip, Titanium
 - D111-30020** 19.5 cm, 1.5 mm tip, Titanium
 - D111-30024** 24.0 cm, 1.5 mm tip, Titanium
 - D111-30315** 15.0 cm, 2.3 mm tip, Titanium
 - D111-30320** 19.5 cm, 2.3 mm tip, Titanium
 - D111-30324** 24.0 cm, 2.3 mm tip, Titanium



- DeBakey**
- D111-30616** 16.0 cm, 1.5 mm jaw
 - D111-30620** 20.0 cm, 1.5 mm jaw
 - D111-30624** 24.0 cm, 1.5 mm jaw
 - D111-30816** 16.0 cm, 2.0 mm jaw
 - D111-30820** 20.0 cm, 2.0 mm jaw
 - D111-30824** 24.0 cm, 2.0 mm jaw
 - D111-30830** 30.0 cm, 2.0 mm jaw
 - D111-30416** 16.0 cm, 2.7 mm jaw
 - D111-30420** 20.0 cm, 2.7 mm jaw
 - D111-30424** 24.0 cm, 2.7 mm jaw
 - D111-30430** 30.0 cm, 2.7 mm jaw
 - D111-31016** 16.0 cm, 3.5 mm jaw
 - D111-31020** 20.0 cm, 3.5 mm jaw
 - D111-31024** 24.0 cm, 3.5 mm jaw
 - D111-31030** 30.0 cm, 3.5 mm jaw



Forceps / Thumb

D144-20616 **Lucae-Jansen**
16.0 cm, serrated



D146-15420 **Jansen Gruenwald**
20.0 cm, serrated









D144-20614 **Lucae**
14.0 cm, serrated











Forceps / Thumb

Jewelers diamond dusted

- | | | |
|-------------------|---|--|
| D110-33525 |  | 11.5 cm, # 5A, very fine pointed tips |
| D110-33503 |  | 11.5 cm, # 3, straight, delicate tips |
| D110-33504 |  | 11.5 cm, # 4, straight, very fine tips |
| D110-33505 |  | 11.0 cm, # 5, straight, ultra fine tips |
| D110-33515 |  | 11.0 cm, # 5/45, angled, ultra fine tips |
| D110-33507 |  | 11.5 cm, # 7, curved, delicate tips |



Jewelers

- | | | |
|-------------------|---|--|
| D110-33201 |  | 11.5 cm, # 1, straight, standard tips |
| D110-33012 |  | 11.5 cm, # 3, straight, delicate tips |
| D110-33225 |  | 11.0 cm, # 5A, very fine pointed tips |
| D110-33010 |  | 10.5 cm, # 3C, straight, delicate tips |
| D110-33204 |  | 11.0 cm, # 4, straight, very fine tips |
| D110-33205 |  | 11.0 cm, # 5, straight, ultra fine tips |
| D110-33100 |  | 11.0 cm, # 5/45, angled, ultra fine tips |
| D110-33112 |  | 11.0 cm, # 7, curved, delicate tips |



Micro-Forceps

round handle, with tying platform

- | | |
|-------------------|---------------------------|
| D111-10415 | 15.0 cm, straight, smooth |
| D111-10818 | 18.0 cm, straight, smooth |
| D111-10515 | 15.0 cm, curved, smooth |
| D111-10918 | 18.0 cm, curved, smooth |





Nasal Rasps

Fomon

- D146-52201** 20.0 cm, #1 and #2, TC
- D146-52203** 20.0 cm, #3 and #4, TC
- D146-52205** 20.0 cm, #5 and #6, TC
- D146-52207** 20.0 cm, #7 and #8, TC



Glabella

- D146-50501** 21.5 cm, TC



Peet

- D146-50919** 19.0 cm, straight
- D146-50920** 19.0 cm, curved



Miller Colburn File

- D182-89501** 18.0 cm, #1
- D182-89502** 18.0 cm, #2
- D182-89503** 18.0 cm, #3
- D182-89504** 18.0 cm, #4
- D182-89505** 18.0 cm, #5



McIndoe

- D146-53018** 17.5 cm, forward cutting, straight



Nasal Rasps

- D146-51916** **Maltz**
16.5 cm,
backward cutting,
straight

- D146-53101** **Lamont**
17.5 cm,
backward cutting, wide,
straight, aggressive teeth

- D146-53102** **Lamont**
17.5 cm,
backward cutting, delicate,
straight, fine teeth

- D146-53103** **Lamont**
17.5 cm,
backward cutting, straight,
fine teeth

- D146-50604** **Parkes**
21.0 cm, # 4, backward cutting,
straight, TC
- D146-50605** 21.0 cm, # 5, backward cutting,
straight, TC
- D146-50608** 21.0 cm, # 8, backward cutting,
straight, TC





Nasal Rasps



Nasal Rasps





Retractors

Ferreira retractor

11.0 cm x 2.2 cm, face lift retractor with fberoptic

D148-56411



Flap retractor

11.0 cm, 2.2 cm blade

D118-56112



Tebbetts Style

T-Mammoplasty retractor with smoke evacuation tube and fberoptical illumination, with Storz, HSW, ACMI adapter included

- D118-55080** 16 x 80 mm blade, without teeth
- D118-55090** 24 x 90 mm blade, without teeth
- D118-55092** 30 x 90 mm blade, without teeth
- D118-55100** 24 x 100 mm blade, without teeth
- D118-55120** 25 x 120 mm blade, without teeth
- D118-55122** 30 x 120 mm blade, without teeth
- D118-55150** 25 x 150 mm blade, without teeth
- D118-55152** 30 x 150 mm blade, without teeth
- D118-55154** 36 x 150 mm blade, without teeth
- D118-55170** 40 x 170 mm blade, without teeth
- D118-55190** 30 x 190 mm blade, without teeth
- D118-55480** 16 x 80 mm blade, with teeth
- D118-55490** 24 x 90 mm blade, with teeth
- D118-55492** 30 x 90 mm blade, with teeth
- D118-55500** 24 x 100 mm blade, with teeth
- D118-55520** 25 x 120 mm blade, with teeth
- D118-55522** 30 x 120 mm blade, with teeth
- D118-55550** 25 x 150 mm blade, with teeth
- D118-55552** 30 x 150 mm blade, with teeth
- D118-55554** 36 x 150 mm blade, with teeth
- D118-55570** 40 x 170 mm blade, with teeth
- D118-55590** 30 x 190 mm blade, with teeth



Retractors

D118-17925

Deaver

20.0 cm, retractor with fiberoptic



D118-19612

Freeman Flap

20.5 cm, retractor, 12 mm blade width

D118-19625

20.5 cm, retractor, 25 mm blade width



D118-56019

Multiple approach retractor

19.0 cm, 23 mm blade



Retractors

D118-57001

Biggs Mammoplasty Retractor

standard blade, 50 mm

D118-57011

standard blade with fiber-optics, 50 mm

D118-57021

standard blade with fiber-optics and suction tube, 50 mm

D118-57002

narrow blade, 31 mm

D118-57012

narrow blade with fiber-optics, 31 mm

D118-57022

narrow blade with fiber-optics and suction tube, 31 mm

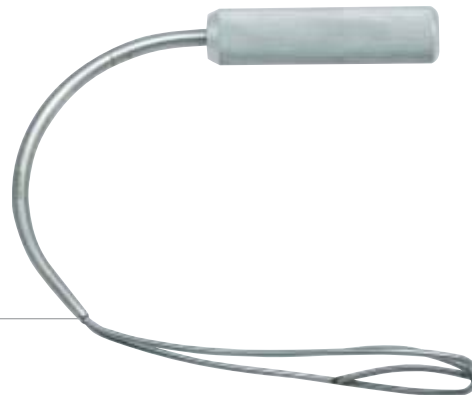

D146-54105

Converse

11.0 cm, nasal retractor,
11x44 mm blade

D146-54125

11.0 cm, nasal retractor,
11x44 mm blade, with fiber optics



D146-55116

Aufricht

16.0 cm, nasal retractor,
45 mm blade

D146-55126

16.0 cm, nasal retractor,
45 mm blade, with fiber optics



D146-55920

Cottle

20.0 cm, retractor
with knife guard



Retractors

- D118-65010** **Weitlaner**
11.5 cm, retractor,
2x3 sharp prongs
- D118-67014**
14.0 cm, retractor,
3x4 sharp prongs



- D146-55508** **Swivel double hook**
8.0 cm, sharp, 10 mm

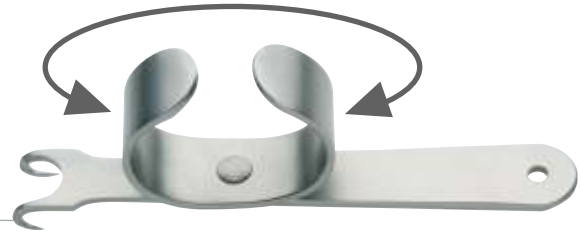





- D146-54516** **Sheen**
16.0 cm, nasal retractor



- D118-17731** **Spatula, semi-malleable**
31.5 cm, 2.5x15.5 cm blade



Retractors

- D118-19516** **Hamra**
16.0 cm, double ended retractor
- 
- D146-55614** **Cottle**
14.0 cm, retractor, double hook, sharp
- 
- D146-55616** **Fomon**
16.0 cm, alar retractor, double hook with ball ends
- 
- D146-55412** **Converse Alar**
10.0 cm, retractor double ended, 10mm / 14mm, blunt
- 
- D146-55511** **Martinez Kilner**
11.5 cm, retractor double hook with thimble, 10mm wide, sharp
- 



Retractors

D118-13121

U.S. Army
21.0 cm, retractor,
double ended, pair



D118-25122
D118-25138

Maxwell Flap
10.0 cm x 22 mm, four prongs retractor
10.0 cm x 38 mm, four prongs retractor



D118-25222
D118-25238

Freeman Rake
18.0 cm x 22 mm,
four prongs retractor
18.0 cm x 38 mm,
four prongs retractor



D118-24911
D118-25011

Anderson Bear Claw
11.0 cm, 3 prongs, sharp
11.0 cm, 5 prongs, sharp



Retractors

D146-56502 **Freeman**
10.0 cm, double skin hook, sharp



D118-25615 **Yancoskie lift retractor**
15.0 cm, 6 prongs



D118-25318 **Lift retractor**
18.0 cm, 7 prongs



Retractors

D118-25438 **Gorney Rake**
7.5 cm, retractor with spring, 38mm wide



D142-37613 **Rollet**
13.0 cm, retractor, delicate, 4 sharp prongs



D118-26513 **Miller Rake**
13.5 cm, tissue retractor, delicate, 9 sharp prongs



D118-24214 **Ragnell**
15.0 cm, double ended retractor, delicate



D118-24314 **Ragnell-Davis**
14.5 cm, double ended retractor





Retractors

- Senn**
D118-16017 17.0 cm,
 double ended retractor, sharp
D118-16117 17.0 cm,
 double ended retractor,
 blunt



- Holtzheimer**
 self retaining retractor, 4 teeth
D118-63510 10.0 cm, blunt, straight
D118-63410 10.0 cm, sharp, straight
D118-63710 10.0 cm, blunt, curved
D118-63610 10.0 cm, sharp, curved



- Farr Spring Retractor**
D118-80120 14.0 cm x 2.0 cm
D118-80121 14.0 cm x 3.0 cm

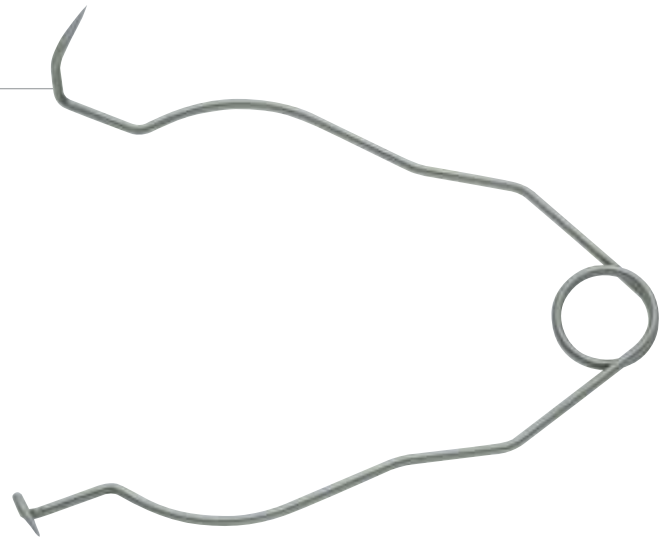

Retractors



Retractors



Retractors

D148-32400 **Dingman Mouth Gag complete**
16.6 cm frame, 3 tongue blades

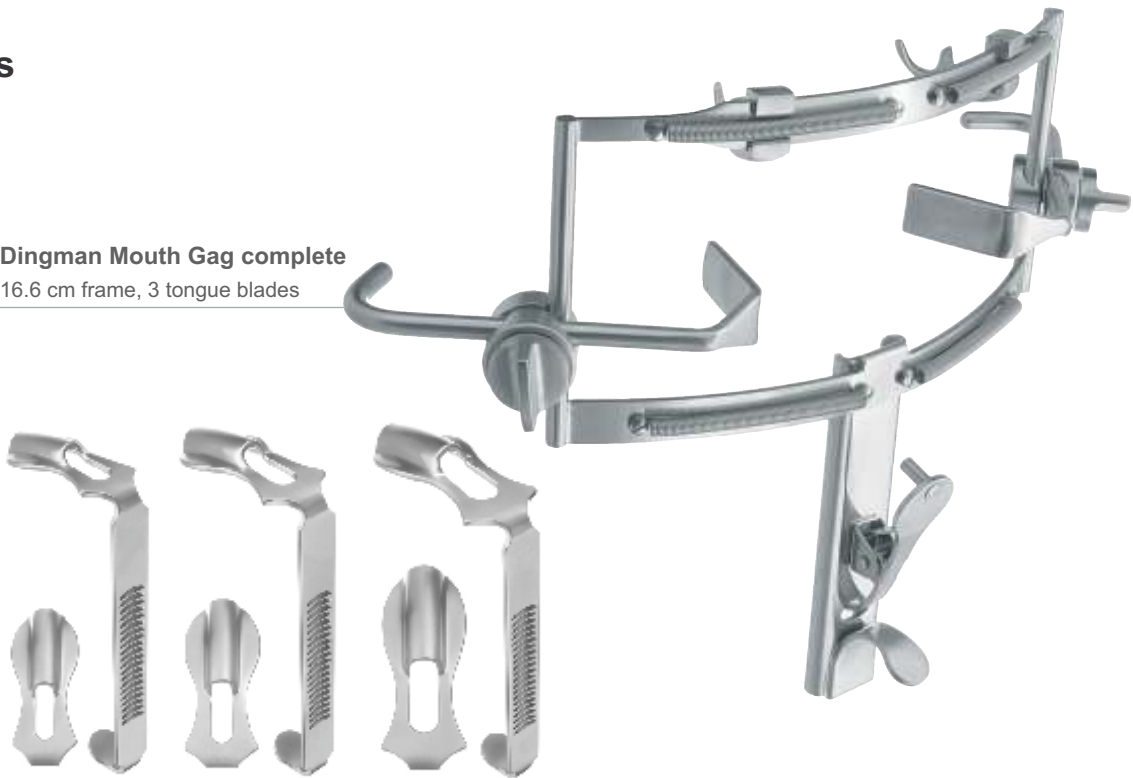

D132-45001 **Lead Hand**
adult size
D132-45002 child size



Breast Retractors

D138-30133 33.0 cm, angled
D138-30142 42.0 cm, angled



D138-30233 33.0 cm, angled, malleable
D138-30242 42.0 cm, angled, malleable



D138-30333 33.0 cm, angled, insulated
D138-30342 42.0 cm, angled, insulated



Breast Retractors

D138-31133 33.0 cm, spatulated

D138-31142 42.0 cm, spatulated



D138-31233 33.0 cm, spatulated, malleable

D138-31242 42.0 cm, spatulated, malleable



D138-31333 33.0 cm, spatulated, insulated





D138-31342 42.0 cm, spatulated, insulated



D138-31432 32.0 cm, oval spatulated blade



Shaper

| | | |
|--------------------------|---|--|
| <p>D138-32001</p> | <p>Scalp Dissector 24.0 cm, slightly curved, 12.5 mm wide</p> |  |
| <p>D138-32011</p> | <p>24.0 cm, slightly curved, 12.5 mm wide, with Ergo Handle</p> | |
| <p>D138-32002</p> | <p>Scalp Dissector 24.0 cm, half curved, with angled tip, 12.5 mm wide</p> |  |
| <p>D138-32012</p> | <p>24.0 cm, half curved, with angled tip, 12.5 mm wide, with Ergo Handle</p> | |
| <p>D138-32003</p> | <p>Dissector 24.0 cm, half curved, 7.0 mm wide</p> |  |
| <p>D138-32013</p> | <p>24.0 cm, half curved, 7.0 mm wide, with Ergo Handle</p> | |
| <p>D138-32004</p> | <p>Transoral Dissector 23.5 cm, curved, 7.0 mm wide</p> |  |
| <p>D138-32014</p> | <p>23.5 cm, curved, 7.0 mm wide, with Ergo Handle</p> | |
| <p>D138-32005</p> | <p>Dissector 24.0 cm, straight, 7.0 mm wide</p> |  |
| <p>D138-32015</p> | <p>24.0 cm, straight, 7.0 mm wide, with Ergo Handle</p> | |



Shaper

- D138-32006** **Flap Dissector**
24.0 cm, curved, 6.5 mm wide
- D138-32016** 24.0 cm, curved, 6.5 mm wide,
with Ergo Handle



- D138-32007** **Frontoglobellar Dissector**
26.5 cm, S-shaped
- D138-32017** 26.5 cm, S-shaped,
with Ergo Handle

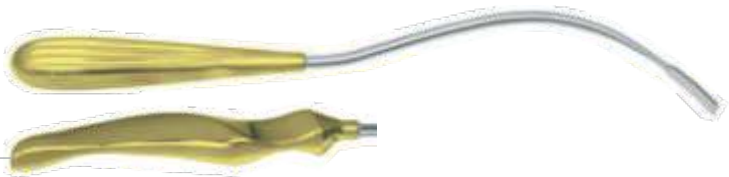

- D138-32008** **Midface Fascia Dissector**
24.0 cm, S-shaped
- D138-32018** 24.0 cm, S-shaped,
with Ergo Handle



- D138-32009** **Flap Dissector**
22.5 cm, straight, 10 mm wide
- D138-32019** 22.5 cm, straight, 10 mm wide,
with Ergo Handle

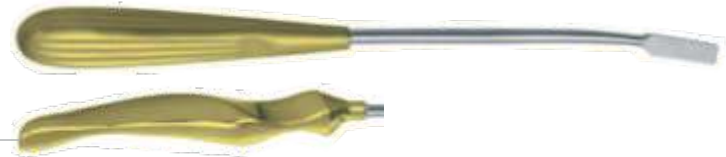

- D138-32101** **Periosteal Dissector**
24.0 cm, S-shaped, 9 mm wide
- D138-32111** 24.0 cm, S-shaped, 9 mm wide,
with Ergo Handle





Shaper

- | | | |
|--------------------------|--|--|
| <p>D138-32102</p> | <p>Nerve Dissector 24.0 cm, slightly curved</p> | |
| <p>D138-32112</p> | <p>24.0 cm, slightly curved, with Ergo Handle</p> | |
| <p>D138-32103</p> | <p>Orbital Rim Dissector 24.0 cm, half curved</p> | |
| <p>D138-32113</p> | <p>24.0 cm, half curved, with Ergo Handle</p> | |
| <p>D138-32104</p> | <p>Temporal Dissector 23.5 cm, straight</p> | |
| <p>D138-32114</p> | <p>23.5 cm, straight, with Ergo Handle</p> | |
| <p>D138-32105</p> | <p>Periosteal Dissector 25.0 cm, curved</p> | |
| <p>D138-32115</p> | <p>25.0 cm, curved, with Ergo Handle</p> | |

Shaper

- D138-33001** **Nerve Hook**
24.0 cm, curved right
- D138-33002** **Nerve Hook**
24.0 cm, curved left



- D138-33123** **Nerve Hook**
23.5 cm, slightly malleable,
with graduation



- D138-33501** **Nerve Protector**
17.0 cm, curved right
- D138-33502** **Nerve Protector**
17.0 cm, curved left



- D138-34001** **Suction Elevator**
slightly curved, round edge



- D138-35023** **Scalpel Handle**
23.0 cm,
for small blades, downwards angled





Osteotomes

Anderson-Neivert

- D146-46907 20.0 cm, straight
- D146-46917 20.0 cm, right
- D146-46927 20.0 cm, left



Gunter

- D146-46307 21.5 cm, straight
- D146-46317 21.5 cm, right
- D146-46327 21.5 cm, left



Silver

rhinoplastic chisel

- D146-47301 18.0 cm, straight
- D146-47302 18.0 cm, right
- D146-47303 18.0 cm, left



Ristow

- D146-47701 20.5 cm, right
- D146-47702 20.5 cm, left



Rees

handle aluminium anodized

- D146-44802 20.5 cm, 2 mm
- D146-44803 20.5 cm, 3 mm



Osteotomes

Parkes

D146-47518 16.0 cm, straight



Converse

- D146-47102** 18.0 cm, 2 mm
- D146-47103** 18.0 cm, 3 mm
- D146-47104** 18.0 cm, 4 mm
- D146-47105** 18.0 cm, 5 mm
- D146-47106** 18.0 cm, 6 mm
- D146-47107** 18.0 cm, 7 mm
- D146-47108** 18.0 cm, 8 mm
- D146-47109** 18.0 cm, 9 mm
- D146-47110** 18.0 cm, 10 mm
- D146-47111** 18.0 cm, 11 mm
- D146-47112** 18.0 cm, 12 mm
- D146-47115** 18.0 cm, 15 mm



Sheehan

- D146-46702** 16.0 cm, 2 mm
- D146-46703** 16.0 cm, 3 mm
- D146-46704** 16.0 cm, 4 mm
- D146-46705** 16.0 cm, 5 mm
- D146-46706** 16.0 cm, 6 mm
- D146-46709** 16.0 cm, 9 mm
- D146-46710** 16.0 cm, 10 mm



Osteotomes

- Cinelli**
- D146-47210 18.5 cm, 10 mm
 - D146-47212 18.5 cm, 12 mm
 - D146-47214 18.5 cm, 14 mm
 - D146-47216 18.5 cm, 16 mm



- Rubin Type**
- D146-46810 17.0 cm, 10 mm
 - D146-46814 17.0 cm, 14 mm
 - D146-46816 17.0 cm, 16 mm



- Parkes Gouge**
- D146-47918 18.0 cm, 6.5 mm



- Sheen angled, Radix Chisel**
- D146-44710 18.0 cm, 10 mm, 10° angle
 - D146-44720 18.0 cm, 10 mm, 20° angle



- Freer Chisel**
- D146-45004 16.5 cm, 4 mm, straight



Mallets

D132-69632
D132-69702

Mead
17.0 cm, 320 g
pair of interchangeable faces



D132-69114

Nylon
18.5 cm, head Nylon / Nylon



D132-69214

Nylon
18.5 cm, head Nylon / Stainless



D132-68625

Gerzog
18.0 cm, 250 g = 8 oz



Morselizers

D146-25318 **Gunter**
18.0 cm, serrated, TC



D146-25520 **Gorney**
18.5 cm, straight



D146-53800 **Cottle**
cartilage-crusher, including forceps for removal



Saws

- Joseph Saw**
H146-53219 19.0 cm, left bayonet
H146-53419 19.0 cm, right bayonet



Curettes

- Converse double ended curette**
D144-76321 21.0 cm, 7.0 x 10.0 and 6.5 x 8.5mm



- Fox dermal curette**
D174-12803 14.0 cm, 3 mm oval
D174-12804 14.0 cm, 4 mm oval
D174-12805 14.0 cm, 5 mm oval



Septum Forceps

- Asch straightening Forceps**
D146-57123 23.0 cm



- Walsham straightening Forceps**
D146-57223 23.0 cm, straight
D146-57323 23.0 cm, left
D146-57523 23.0 cm, right





Nasal Speculas

Vienna

- D146-11201 14.0 cm, for baby
- D146-11202 14.0 cm, for child
- D146-11203 14.0 cm, for adult



Killian

- D146-12035 13.0 cm, 35 mm
- D146-12050 13.0 cm, 50 mm
- D146-12075 13.0 cm, 75 mm
- D146-12090 13.0 cm, 90 mm



Cottle

- D146-12435 14.0 cm, 35 mm
- D146-12450 14.0 cm, 50 mm
- D146-12475 14.0 cm, 75 mm
- D146-12490 14.0 cm, 90 mm



Elevators

D132-81921 **Rowe's**
21.0 cm,
Zygomatic bone elevator



D146-43124 **McCulloch**
24.0 cm, double ended blunt
elevator, 4.2 mm



D146-40119 **Gorney Suction**
19.0 cm, round end,
suction-elevator



D146-42123 **Cottle Septum**
23.0 cm



D146-42516 **Joseph**
16.5 cm, periosteal elevator







Elevators

- D146-41645** **Freer**
 19.0 cm, tip 4.5 mm, sharp/blunt
- D146-41665** 19.0 cm, tip 6.5 mm, sharp/blunt

- D146-40418** **McCollough**
 18.5 cm

- D146-50318** **Woodson**
 20.0 cm

- D146-42519** **Cottle Skin**
 19.0 cm, 10 mm wide

- D146-43317** **Mitchells Trimmer**
 17.0 cm, knife blade and spoon shaped elevator



Elevators

Obwegeser Periosteal
D148-69907 18.0 cm, 7 mm
D148-69911 18.0 cm, 11 mm



Boies
D146-57719 19.5 cm







Carlin
D148-56600 15.5 cm, chin implant
 periosteal elevator



Clodius
D148-58500 orbital retractor, double ended,
 13 mm / 20 mm







Hooks

| | | |
|--|--|--|
| <p>D118-21413 D118-21418</p> | <p>Frazier Skin Hook 13.0 cm, sharp 18.0 cm, sharp</p> |  |
| <p>D118-20913</p> | <p>O'Conner Iris Skin Hook 12.5 cm, sharp</p> |  |
| <p>D118-20501 D118-20503</p> | <p>Converse Skin Hook 19.0 cm, small 19.0 cm, large</p> |  |
| <p>D118-21601 D118-21602 D118-21605 D118-21607 D118-21610</p> | <p>Joseph Skin Hook 16.0 cm, single hook 16.0 cm, 2 mm double hook 16.0 cm, 5 mm double hook 16.0 cm, 7 mm double hook 16.0 cm, 10 mm double hook</p> |  |
| <p>D118-20803 D118-20805 D118-20807</p> | <p>Kleinert-Kutz Hook 16.0 cm, 3 mm 16.0 cm, 5 mm 16.0 cm, 7 mm</p> |  |



Hooks

- | | | |
|--|--|--|
| D146-55218 | <p>Millard Thimble Hook 18 mm wide, double hook</p> |  |
| <p>D146-55701 D146-55702 D146-55703</p> | <p>Cottle Tenaculum 15.0 cm, Fig. 1 15.0 cm, Fig. 2 15.0 cm, Fig. 3</p> |  |
| <p>D118-21201 D118-21202</p> | <p>Guthrie Double Hook 12.0 cm, 2.5 mm 12.0 cm, 3.0 mm</p> |  |
| D118-20413 | <p>Tyrell Skin Hook 13.0 cm</p> |  |
| <p>D146-56018 D146-56218</p> | <p>Gillies Skin Hook 18.0 cm, Fig. 1 18.0 cm, Fig. 2</p> |  |
| D146-56614 | <p>Barsky Double Skin Hook 15.0 cm, 5 mm</p> |  |



Measuring

D102-31911

Thorpe Precision Caliper
12.5 cm



D142-58307

Castroviejo Caliper
9.0 cm



D102-31710

Jameson Caliper
10.0 cm



D102-31811

Thorpe Caliper, angled
12.0 cm



Dissectors



Markers

D138-10400 **Grossmann**
Areola Marker
4 sizes



D138-10534 **Freeman**
Areola Marker
34 mm
D138-10536 36 mm
D138-10538 38 mm
D138-10542 42 mm
D138-10545 45 mm
D138-10550 50 mm



D138-11038 **McKissock "keyhole"**
used in conjunction
with Freeman Areola Marker
38 mm
D138-11042 42 mm
D138-11045 45 mm



D138-10738 **Freeman**
38/42 mm diameter
D138-10742 42/45 mm diameter



D138-11414 **Ackerman**
Areola Marker
10.0 cm
D138-11416 11.5 cm

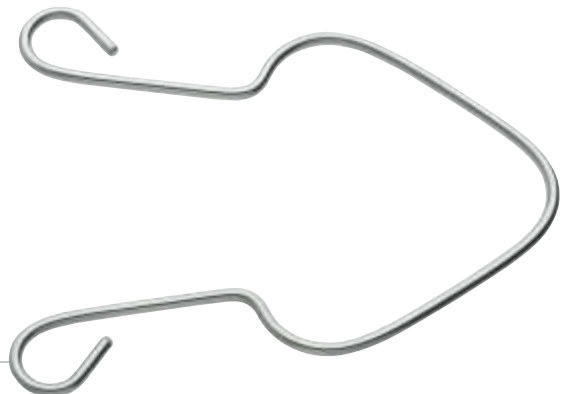

Markers

D138-20216 D'Assumpcao F/L 16.0 cm
D138-20316 16.0 cm, with ratchet



D138-20916 Pitanguy Flap Demarcator 16.0 cm, facial



D138-20714 Marten Flap 14.5 cm
D138-20614 14.5 cm, with ratchet



Forceps

Hartmann Mosquito
 D112-21010 10.0 cm, straight
 D112-21110 10.0 cm, curved



Halstead Mosquito
 D112-23012 12.5 cm, straight, 1x2 teeth
 D112-23112 12.5 cm, curved, 1x2 teeth
 D112-22012 12.5 cm, straight
 D112-22112 12.5 cm, curved



Kelly
 D112-24014 14.0 cm, straight
 D112-24114 14.0 cm, curved



Crile
 hemostatic forceps
 D112-25014 14.0 cm, straight
 D112-25114 14.0 cm, curved
 D112-26316 16.0 cm, curved



Forceps

Rochester Pean hemostatic forceps

- D112-31014** 14.0 cm, straight
- D112-31016** 16.0 cm, straight
- D112-31020** 20.0 cm, straight
- D112-31116** 16.0 cm, curved
- D112-31118** 18.0 cm, curved
- D112-31120** 20.0 cm, curved



Rochester-Ochsner hemostatic forceps

- D112-32014** 14.0 cm, straight, 1x2 teeth
- D112-32114** 14.0 cm, curved, 1x2 teeth
- D112-32016** 16.0 cm, straight, 1x2 teeth
- D112-32116** 16.0 cm, curved, 1x2 teeth



Adson hemostatic forceps

- D112-41018** 18.5 cm, straight
- D112-41118** 18.5 cm, curved



Forceps

Lahey Vulsellum
D154-52015 15.0 cm
D154-52020 20.0 cm



Allis
D164-10214 14.0 cm, 4:5 teeth, Allis Baby
D164-11015 15.0 cm, 4:5 teeth
D164-12015 15.0 cm, 5:6 teeth
D164-12019 19.0 cm, 5:6 teeth



Backhaus Towel
D114-11109 9.0 cm
D114-11111 11.0 cm
D114-11113 13.0 cm
D114-11115 15.0 cm



Forceps

Lorna Towel
D114-12111 11.0 cm
D114-12113 13.0 cm



Jones Towel
D114-10309 9.0 cm



Foerster Sponge Holding
D116-17018 18.0 cm
D116-17020 20.0 cm
D116-17025 25.0 cm



Knives

- D146-39003
- D146-39004
- D146-39005
- D146-39203
- D146-39204
- D146-39205

Ballenger Swivel

- 20.0 cm, straight, 3 mm blade
- 20.0 cm, straight, 4 mm blade
- 20.0 cm, straight, 5 mm blade
- 20.0 cm, bayonet, 3 mm blade
- 20.0 cm, bayonet, 4 mm blade
- 20.0 cm, bayonet, 5 mm blade



Freer Mucosa Knife

- D146-37415

15.0 cm, "D" pattern



Silver Dermatome

- D106-48219

19.0 cm



Knives

D106-48230
D106-48401

Watson Dermatome

30.0 cm, complete
spare blade (1pc.)



D138-14027

Foerster

27.0 cm,
capsulotomy knife



D106-10303

Scalpel Handle

14.5 cm, Fig. 3, round



D106-10301

Scalpel Handle No. 3

12.0 cm, with cm-graduation



Rongeurs

D132-15016
D132-15116

Lempert
16.0 cm, straight
16.0 cm, curved



D132-20118

Beyer
18.0 cm, curved



Bone Cutting Forceps

D146-32519 **Jansen Middleton**
nasal cutting forceps
19.5 cm



D146-21002 **Takahashi Cutting Forceps**
11.5 cm, working length, 2.5x8 mm bite



D132-28314 **Kleinert-Kutz Forceps**
14.0 cm, straight
D132-28414 14.0 cm, curved



Miscellaneous

Ruler

graduated in mm and inches

- D102-34010 10.0 cm
- D102-34020 20.0 cm
- D102-34030 30.0 cm
- D102-34050 50.0 cm



Barron Suction Tubes

- D144-10103 13.0 cm, 3 french
- D144-10105 13.0 cm, 5 french
- D144-10107 13.0 cm, 7 french



Yankauer Aspiration Tube

27.0 cm, complete with suction tip and connector

- D104-15027



Miscellaneous

D133-53820 **Universal Flat Nose Pliers**
20.0 cm



D133-53202 **Wire Seizing Forceps**
18.0 cm, 4 mm
D133-53203 18.0 cm, 6 mm



D133-56814 **Needle Nose Pliers**
14.0 cm, cross-serrated



Miscellaneous

D133-53803

General Purpose Pliers
18.0 cm



D133-54717
D133-54522

Wire/Pin Cutter
18.0 cm, 1.7 wire, TC
22.0 cm, 2.5 wire, TC



D133-54618

Wire/Pin Cutter
18.0 cm, TC



Cannulas / Lipo Suction



| | Triport working length | Ø |
|-------------------|----------------------------------|------|
| D138-41315 | 150 mm | 3 mm |
| D138-41320 | 200 mm | 3 mm |
| D138-41325 | 250 mm | 3 mm |
| D138-41330 | 300 mm | 3 mm |
| D138-41420 | 200 mm | 4 mm |
| D138-41425 | 250 mm | 4 mm |
| D138-41430 | 300 mm | 4 mm |
| D138-41525 | 250 mm | 5 mm |
| D138-41530 | 300 mm | 5 mm |



| | Monoport working length | Ø |
|-------------------|-----------------------------------|------|
| D138-42315 | 150 mm | 3 mm |
| D138-42320 | 200 mm | 3 mm |
| D138-42325 | 250 mm | 3 mm |
| D138-42330 | 300 mm | 3 mm |
| D138-42420 | 200 mm | 4 mm |
| D138-42425 | 250 mm | 4 mm |
| D138-42430 | 300 mm | 4 mm |
| D138-42525 | 250 mm | 5 mm |
| D138-42530 | 300 mm | 5 mm |



Cannulas / Lipo Suction

| | Cobra | |
|-------------------|----------------|------|
| | working length | Ø |
| D138-43315 | 150 mm | 3 mm |
| D138-43320 | 200 mm | 3 mm |
| D138-43325 | 250 mm | 3 mm |
| D138-43420 | 200 mm | 4 mm |
| D138-43425 | 250 mm | 4 mm |
| D138-43430 | 300 mm | 4 mm |
| D138-43525 | 250 mm | 5 mm |
| D138-43530 | 300 mm | 5 mm |



| | Spirale | |
|-------------------|----------------|------|
| | working length | Ø |
| D138-44315 | 150 mm | 3 mm |
| D138-44320 | 200 mm | 3 mm |
| D138-44325 | 250 mm | 3 mm |
| D138-44420 | 200 mm | 4 mm |
| D138-44425 | 250 mm | 4 mm |
| D138-44430 | 300 mm | 4 mm |
| D138-44525 | 250 mm | 5 mm |
| D138-44530 | 300 mm | 5 mm |



| | Shark | |
|-------------------|----------------|------|
| | working length | Ø |
| D138-45315 | 150 mm | 3 mm |
| D138-45320 | 200 mm | 3 mm |
| D138-45325 | 250 mm | 3 mm |
| D138-45420 | 200 mm | 4 mm |
| D138-45425 | 250 mm | 4 mm |
| D138-45430 | 300 mm | 4 mm |
| D138-45525 | 250 mm | 5 mm |
| D138-45530 | 300 mm | 5 mm |



Cannulas / Lipo Suction

Lipo Hand piece

with thumb control,
luer lock

D138-40030



Triport

working length Ø

| | | |
|-------------------|--------|------|
| D138-46320 | 200 mm | 3 mm |
| D138-46325 | 250 mm | 3 mm |
| D138-46420 | 200 mm | 4 mm |
| D138-46425 | 250 mm | 4 mm |
| D138-46430 | 300 mm | 4 mm |
| D138-46525 | 250 mm | 5 mm |
| D138-46530 | 300 mm | 5 mm |



Mercedes

working length Ø

| | | |
|-------------------|--------|------|
| D138-47320 | 200 mm | 3 mm |
| D138-47325 | 250 mm | 3 mm |
| D138-47420 | 200 mm | 4 mm |
| D138-47425 | 250 mm | 4 mm |
| D138-47430 | 300 mm | 4 mm |
| D138-47525 | 250 mm | 5 mm |
| D138-47530 | 300 mm | 5 mm |



Spirale

working length Ø

| | | |
|-------------------|--------|------|
| D138-48320 | 200 mm | 3 mm |
| D138-48325 | 250 mm | 3 mm |
| D138-48420 | 200 mm | 4 mm |
| D138-48425 | 250 mm | 4 mm |
| D138-48430 | 300 mm | 4 mm |
| D138-48525 | 250 mm | 5 mm |
| D138-48530 | 300 mm | 5 mm |



Order Number Index

| art.-no. | page | art.-no. | page | art.-no. | page | art.-no. | page | art.-no. | page |
|------------|------|------------|------|------------|------|-------------|------|------------|------|
| D102-31710 | 70 | D108-21220 | 4 | D108-28615 | 13 | D108-39518 | 10 | D110-18805 | 29 |
| D102-31811 | 70 | D108-21320 | 4 | D108-28618 | 13 | D108-40118 | 10 | D110-18812 | 29 |
| D102-31911 | 70 | D108-21420 | 4 | D108-28620 | 13 | D108-40213 | 11 | D110-18851 | 30 |
| D102-34010 | 82 | D108-21518 | 4 | D108-28623 | 13 | D108-40354 | 11 | D110-20012 | 30 |
| D102-34020 | 82 | D108-21520 | 4 | D108-28628 | 13 | D108-40716 | 11 | D110-20412 | 28 |
| D102-34030 | 82 | D108-21523 | 4 | D108-28715 | 13 | D108-53916 | 9 | D110-20512 | 28 |
| D102-34050 | 82 | D108-21617 | 17 | D108-28718 | 13 | D108-80209 | 16 | D110-22217 | 32 |
| D104-15027 | 82 | D108-21620 | 4 | D108-28720 | 13 | D108-82313 | 6 | D110-22417 | 32 |
| D106-10301 | 79 | D108-21720 | 4 | D108-28723 | 13 | D108-83512 | 15 | D110-22517 | 32 |
| D106-10303 | 79 | D108-21818 | 6 | D108-28728 | 13 | D108-90114 | 17 | D110-22618 | 32 |
| D106-48219 | 78 | D108-21820 | 6 | D108-30414 | 9 | D108-90118 | 17 | D110-25317 | 32 |
| D106-48230 | 79 | D108-21918 | 4 | D108-30454 | 9 | D108-93114 | 16 | D110-25815 | 31 |
| D106-48401 | 79 | D108-22018 | 4 | D108-30514 | 9 | D109-20615 | 17 | D110-26915 | 31 |
| D107-17017 | 14 | D108-22417 | 5 | D108-30554 | 9 | D109-20618 | 17 | D110-27215 | 31 |
| D107-17117 | 14 | D108-22419 | 5 | D108-30612 | 9 | D109-20715 | 17 | D110-30118 | 33 |
| D107-28015 | 12 | D108-22517 | 5 | D108-31212 | 8 | D109-20718 | 17 | D110-30618 | 33 |
| D107-28018 | 12 | D108-22519 | 5 | D108-31412 | 8 | D109-20815 | 17 | D110-32323 | 33 |
| D107-28023 | 12 | D108-23312 | 5 | D108-32209 | 16 | D109-20818 | 17 | D110-33010 | 35 |
| D107-28115 | 12 | D108-23315 | 5 | D108-32309 | 16 | D109-20915 | 17 | D110-33012 | 35 |
| D107-28118 | 12 | D108-23323 | 5 | D108-32610 | 16 | D109-20918 | 17 | D110-33100 | 35 |
| D107-28123 | 12 | D108-24018 | 6 | D108-32710 | 16 | D110-11115 | 31 | D110-33112 | 35 |
| D107-37411 | 8 | D108-24516 | 5 | D108-34011 | 8 | D110-11618 | 32 | D110-33201 | 35 |
| D107-37511 | 8 | D108-24520 | 5 | D108-34111 | 8 | D110-11621 | 32 | D110-33204 | 35 |
| D108-10614 | 15 | D108-24816 | 6 | D108-34211 | 8 | D110-11625 | 32 | D110-33205 | 35 |
| D108-10714 | 15 | D108-27415 | 13 | D108-34251 | 8 | D110-16912 | 29 | D110-33225 | 35 |
| D108-11214 | 14 | D108-27418 | 13 | D108-34311 | 8 | D110-17012 | 28 | D110-33503 | 35 |
| D108-11314 | 14 | D108-27423 | 13 | D108-34351 | 8 | D110-17312 | 29 | D110-33504 | 35 |
| D108-12214 | 15 | D108-27515 | 13 | D108-34411 | 8 | D110-17315 | 29 | D110-33505 | 35 |
| D108-12314 | 15 | D108-27518 | 13 | D108-34511 | 8 | D110-17412 | 28 | D110-33507 | 35 |
| D108-17415 | 13 | D108-27523 | 13 | D108-35010 | 10 | D110-17415 | 28 | D110-33515 | 35 |
| D108-17417 | 13 | D108-28415 | 12 | D108-36011 | 7 | D110-17452 | 29 | D110-33525 | 35 |
| D108-17515 | 13 | D108-28418 | 12 | D108-36051 | 7 | D110-17455 | 29 | D111-10415 | 35 |
| D108-17517 | 13 | D108-28420 | 12 | D108-36111 | 7 | D110-17512 | 28 | D111-10515 | 35 |
| D108-19421 | 14 | D108-28423 | 12 | D108-36151 | 7 | D110-17515 | 28 | D111-10818 | 35 |
| D108-19521 | 14 | D108-28428 | 12 | D108-36211 | 7 | D110-17612 | 28 | D111-10918 | 35 |
| D108-20512 | 16 | D108-28515 | 12 | D108-36311 | 7 | D110-17912 | 28 | D111-30015 | 33 |
| D108-20514 | 16 | D108-28518 | 12 | D108-36509 | 15 | D110-18012 | 28 | D111-30020 | 33 |
| D108-20911 | 7 | D108-28520 | 12 | D108-36512 | 15 | D110-18512 | 29 | D111-30024 | 33 |
| D108-20914 | 7 | D108-28523 | 12 | D108-37411 | 8 | D110-18612D | 29 | D111-30315 | 33 |
| D108-21011 | 7 | D108-28528 | 12 | D108-37511 | 8 | D110-18802 | 29 | D111-30320 | 33 |

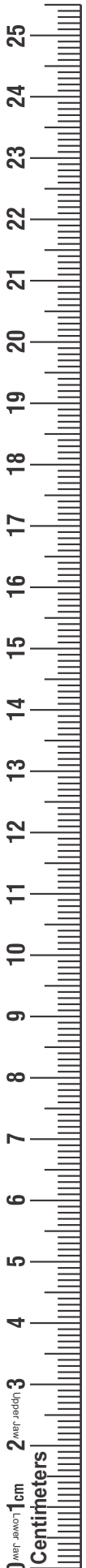

Order Number Index

| art.-no. | page | art.-no. | page | art.-no. | page | art.-no. | page | art.-no. | page |
|------------|------|------------|------|------------|------|------------|------|------------|------|
| D111-30324 | 33 | D114-11113 | 76 | D118-25222 | 45 | D118-65010 | 43 | D124-24817 | 21 |
| D111-30416 | 33 | D114-11115 | 76 | D118-25238 | 45 | D118-67014 | 43 | D124-24819 | 21 |
| D111-30420 | 33 | D114-12111 | 77 | D118-25318 | 46 | D118-80120 | 48 | D124-41414 | 23 |
| D111-30424 | 33 | D114-12113 | 77 | D118-25438 | 47 | D118-80121 | 48 | D124-41418 | 23 |
| D111-30430 | 33 | D116-17018 | 77 | D118-25615 | 46 | D122-32014 | 75 | D124-43416 | 23 |
| D111-30616 | 33 | D116-17020 | 77 | D118-26513 | 47 | D122-32114 | 75 | D124-63414 | 25 |
| D111-30620 | 33 | D116-17025 | 77 | D118-55080 | 40 | D124-11012 | 19 | D124-63415 | 25 |
| D111-30624 | 33 | D118-13121 | 45 | D118-55090 | 40 | D124-11412 | 19 | D124-63418 | 25 |
| D111-30816 | 33 | D118-16017 | 48 | D118-55092 | 40 | D124-12811 | 18 | D124-63514 | 25 |
| D111-30820 | 33 | D118-16117 | 48 | D118-55100 | 40 | D124-12913 | 18 | D124-63515 | 25 |
| D111-30824 | 33 | D118-17731 | 43 | D118-55120 | 40 | D124-13413 | 18 | D124-63518 | 25 |
| D111-30830 | 33 | D118-17925 | 41 | D118-55122 | 40 | D124-14011 | 18 | D124-63614 | 25 |
| D111-31016 | 33 | D118-19516 | 44 | D118-55150 | 40 | D124-14013 | 18 | D124-63615 | 25 |
| D111-31020 | 33 | D118-19612 | 41 | D118-55152 | 40 | D124-14413 | 18 | D124-63618 | 25 |
| D111-31024 | 33 | D118-19625 | 41 | D118-55154 | 40 | D124-14713 | 19 | D124-63714 | 25 |
| D111-31030 | 33 | D118-20413 | 69 | D118-55170 | 40 | D124-15412 | 22 | D124-63715 | 25 |
| D112-21010 | 74 | D118-20501 | 68 | D118-55190 | 40 | D124-15414 | 22 | D124-63718 | 25 |
| D112-21110 | 74 | D118-20503 | 68 | D118-55480 | 40 | D124-16215 | 21 | D124-64014 | 24 |
| D112-22012 | 74 | D118-20803 | 68 | D118-55490 | 40 | D124-16415 | 21 | D124-64015 | 24 |
| D112-22112 | 74 | D118-20805 | 68 | D118-55492 | 40 | D124-16418 | 21 | D124-64018 | 24 |
| D112-23012 | 74 | D118-20807 | 68 | D118-55500 | 40 | D124-16420 | 21 | D124-64114 | 24 |
| D112-23112 | 74 | D118-20913 | 68 | D118-55520 | 40 | D124-16423 | 21 | D124-64115 | 24 |
| D112-24014 | 74 | D118-21201 | 69 | D118-55522 | 40 | D124-18414 | 22 | D124-64118 | 24 |
| D112-24114 | 74 | D118-21202 | 69 | D118-55550 | 40 | D124-18416 | 22 | D124-64214 | 24 |
| D112-25014 | 74 | D118-21413 | 68 | D118-55552 | 40 | D124-18418 | 22 | D124-64215 | 24 |
| D112-25114 | 74 | D118-21418 | 68 | D118-55554 | 40 | D124-18420 | 22 | D124-64218 | 24 |
| D112-26316 | 74 | D118-21601 | 68 | D118-55570 | 40 | D124-21815 | 19 | D124-64314 | 24 |
| D112-31014 | 75 | D118-21602 | 68 | D118-55590 | 40 | D124-22413 | 20 | D124-64315 | 24 |
| D112-31016 | 75 | D118-21605 | 68 | D118-56019 | 41 | D124-22415 | 20 | D124-64318 | 24 |
| D112-31020 | 75 | D118-21607 | 68 | D118-56112 | 40 | D124-22418 | 20 | D124-65712 | 27 |
| D112-31116 | 75 | D118-21610 | 68 | D118-57001 | 42 | D124-22613 | 20 | D124-65912 | 27 |
| D112-31118 | 75 | D118-23908 | 49 | D118-57002 | 42 | D124-22615 | 20 | D124-66614 | 26 |
| D112-31120 | 75 | D118-23914 | 49 | D118-57011 | 42 | D124-22618 | 20 | D124-66615 | 26 |
| D112-32016 | 75 | D118-24214 | 47 | D118-57012 | 42 | D124-23415 | 21 | D124-66618 | 26 |
| D112-32116 | 75 | D118-24314 | 47 | D118-57021 | 42 | D124-23418 | 21 | D124-66714 | 26 |
| D112-41018 | 75 | D118-24316 | 49 | D118-57022 | 42 | D124-23814 | 20 | D124-66715 | 26 |
| D112-41118 | 75 | D118-24911 | 45 | D118-63410 | 48 | D124-23815 | 20 | D124-66718 | 26 |
| D114-10309 | 77 | D118-25011 | 45 | D118-63510 | 48 | D124-23818 | 20 | D124-66814 | 26 |
| D114-11109 | 76 | D118-25122 | 45 | D118-63610 | 48 | D124-23820 | 20 | D124-66815 | 26 |
| D114-11111 | 76 | D118-25138 | 45 | D118-63710 | 48 | D124-24814 | 21 | D124-66818 | 26 |



Order Number Index

| art.-no. | page | art.-no. | page | art.-no. | page | art.-no. | page | art.-no. | page |
|------------|------|------------|------|------------|------|------------|------|------------|------|
| D124-66914 | 26 | D133-53820 | 83 | D138-30233 | 52 | D138-32115 | 56 | D138-44325 | 86 |
| D124-66915 | 26 | D133-53901 | 23 | D138-30242 | 52 | D138-33001 | 57 | D138-44420 | 86 |
| D124-66918 | 26 | D133-53902 | 23 | D138-30333 | 52 | D138-33002 | 57 | D138-44425 | 86 |
| D124-67513 | 26 | D133-53903 | 23 | D138-30342 | 52 | D138-33123 | 57 | D138-44430 | 86 |
| D124-67514 | 26 | D133-54522 | 84 | D138-31133 | 53 | D138-33501 | 57 | D138-44525 | 86 |
| D124-67517 | 26 | D133-54618 | 84 | D138-31142 | 53 | D138-33502 | 57 | D138-44530 | 86 |
| D124-67518 | 26 | D133-54717 | 84 | D138-31233 | 53 | D138-34001 | 57 | D138-45315 | 86 |
| D124-67813 | 26 | D133-56814 | 83 | D138-31242 | 53 | D138-35023 | 57 | D138-45320 | 86 |
| D124-67814 | 26 | D133-60001 | 22 | D138-31333 | 53 | D138-40010 | 85 | D138-45325 | 86 |
| D124-67817 | 26 | D133-60002 | 22 | D138-31342 | 53 | D138-40020 | 87 | D138-45420 | 86 |
| D124-67819 | 26 | D133-60011 | 22 | D138-31432 | 53 | D138-41315 | 85 | D138-45425 | 86 |
| D124-69614 | 27 | D133-60012 | 22 | D138-32001 | 54 | D138-41320 | 85 | D138-45430 | 86 |
| D124-69618 | 27 | D138-10400 | 72 | D138-32002 | 54 | D138-41325 | 85 | D138-45525 | 86 |
| D124-69714 | 27 | D138-10534 | 72 | D138-32003 | 54 | D138-41330 | 85 | D138-45530 | 86 |
| D124-69718 | 27 | D138-10536 | 72 | D138-32004 | 54 | D138-41420 | 85 | D138-46320 | 87 |
| D124-69814 | 27 | D138-10538 | 72 | D138-32005 | 54 | D138-41425 | 85 | D138-46325 | 87 |
| D124-69818 | 27 | D138-10542 | 72 | D138-32006 | 55 | D138-41430 | 85 | D138-46420 | 87 |
| D124-69914 | 27 | D138-10545 | 72 | D138-32007 | 55 | D138-41525 | 85 | H138-46425 | 87 |
| D124-69918 | 27 | D138-10550 | 72 | D138-32008 | 55 | D138-41530 | 85 | H138-46430 | 87 |
| D124-70214 | 27 | D138-10738 | 72 | D138-32009 | 55 | D138-42315 | 85 | H138-46525 | 87 |
| D124-70218 | 27 | D138-10742 | 72 | D138-32011 | 54 | D138-42320 | 85 | H138-46530 | 87 |
| D128-41001 | 39 | D138-11038 | 72 | D138-32012 | 54 | D138-42325 | 85 | H138-47320 | 87 |
| D132-15016 | 80 | D138-11042 | 72 | D138-32013 | 54 | D138-42330 | 85 | H138-47325 | 87 |
| D132-15116 | 80 | D138-11045 | 72 | D138-32014 | 54 | D138-42420 | 85 | H138-47420 | 87 |
| D132-20118 | 80 | D138-11414 | 72 | D138-32015 | 54 | D138-42425 | 85 | H138-47425 | 87 |
| D132-28314 | 81 | D138-11416 | 72 | D138-32016 | 55 | D138-42430 | 85 | H138-47430 | 87 |
| D132-28414 | 81 | D138-14027 | 79 | D138-32017 | 55 | D138-42525 | 85 | H138-47525 | 87 |
| D132-45001 | 51 | D138-15030 | 71 | D138-32018 | 55 | D138-42530 | 85 | H138-47530 | 87 |
| D132-45002 | 51 | D138-15041 | 71 | D138-32019 | 55 | D138-43315 | 86 | H138-48320 | 87 |
| D132-68625 | 61 | D138-15536 | 71 | D138-32101 | 55 | D138-43320 | 86 | H138-48325 | 87 |
| D132-69114 | 61 | D138-16033 | 71 | D138-32102 | 56 | D138-43325 | 86 | H138-48420 | 87 |
| D132-69214 | 61 | D138-20216 | 73 | D138-32103 | 56 | D138-43420 | 86 | H138-48425 | 87 |
| D132-69632 | 61 | D138-20316 | 73 | D138-32104 | 56 | D138-43425 | 86 | H138-48430 | 87 |
| D132-69702 | 61 | D138-20614 | 73 | D138-32105 | 56 | D138-43430 | 86 | H138-48525 | 87 |
| D132-81921 | 65 | D138-20714 | 73 | H138-32111 | 55 | H138-43525 | 86 | H138-48530 | 87 |
| D133-53202 | 83 | D138-20916 | 73 | H138-32112 | 56 | H138-43530 | 86 | H142-37613 | 47 |
| D133-53203 | 83 | D138-30133 | 52 | H138-32113 | 56 | H138-44315 | 86 | H142-58307 | 70 |
| D133-53803 | 84 | D138-30142 | 52 | H138-32114 | 56 | H138-44320 | 86 | H142-81010 | 30 |



Order Number Index

| art.-no. | page | art.-no. | page | art.-no. | page | art.-no. | page | art.-no. | page |
|------------|------|------------|------|------------|------|------------|------|------------|------|
| D142-82010 | 30 | D146-37415 | 78 | D146-47103 | 59 | D146-52401 | 38 | D148-56600 | 67 |
| D142-82511 | 30 | D146-39003 | 78 | D146-47104 | 59 | D146-52402 | 38 | D148-57215 | 50 |
| D142-94004 | 31 | D146-39004 | 78 | D146-47105 | 59 | D146-52521 | 39 | D148-57701 | 50 |
| D142-94006 | 31 | D146-39005 | 78 | D146-47106 | 59 | D146-53018 | 36 | D148-58500 | 67 |
| D143-07605 | 31 | D146-39203 | 78 | D146-47107 | 59 | D146-53101 | 37 | D148-58716 | 49 |
| D143-07610 | 31 | D146-39204 | 78 | D146-47108 | 59 | D146-53102 | 37 | D148-69907 | 67 |
| D143-07612 | 31 | D146-39205 | 78 | D146-47109 | 59 | D146-53103 | 37 | D148-69911 | 67 |
| D143-07805 | 31 | D146-40119 | 65 | D146-47110 | 59 | D146-53219 | 63 | D148-90301 | 49 |
| D143-07810 | 31 | D146-40418 | 66 | D146-47111 | 59 | D146-53419 | 63 | D148-90416 | 50 |
| D143-07812 | 31 | D146-41645 | 66 | D146-47112 | 59 | D146-53800 | 62 | D154-52015 | 76 |
| D143-14903 | 30 | D146-41665 | 66 | D146-47115 | 59 | D146-54105 | 42 | D154-52020 | 76 |
| D143-14905 | 30 | D146-42123 | 65 | D146-47210 | 60 | D146-54125 | 42 | D164-10214 | 76 |
| D143-14909 | 30 | D146-42516 | 65 | D146-47212 | 60 | D146-54516 | 43 | D164-11015 | 76 |
| D143-14915 | 30 | D146-42519 | 66 | D146-47214 | 60 | D146-54615 | 50 | D164-12015 | 76 |
| D144-10103 | 82 | D146-43124 | 65 | D146-47216 | 60 | D146-55116 | 42 | D164-12019 | 76 |
| D144-10105 | 82 | D146-43317 | 66 | D146-47301 | 58 | D146-55126 | 42 | D174-12803 | 63 |
| D144-10107 | 82 | D146-44710 | 60 | D146-47302 | 58 | D146-55218 | 69 | D174-12804 | 63 |
| D144-20614 | 34 | D146-44720 | 60 | D146-47303 | 58 | D146-55412 | 44 | D174-12805 | 63 |
| D144-20616 | 34 | D146-44802 | 58 | D146-47518 | 59 | D146-55508 | 43 | D182-89501 | 36 |
| D144-76321 | 63 | D146-44803 | 58 | D146-47701 | 58 | D146-55511 | 44 | D182-89502 | 36 |
| D146-11201 | 64 | D146-45004 | 60 | D146-47702 | 58 | D146-55614 | 44 | D182-89503 | 36 |
| D146-11202 | 64 | D146-46307 | 58 | D146-47918 | 60 | D146-55616 | 44 | D182-89504 | 36 |
| D146-11203 | 64 | D146-46317 | 58 | D146-50318 | 66 | D146-55701 | 69 | D182-89505 | 36 |
| D146-12035 | 64 | D146-46327 | 58 | D146-50501 | 36 | D146-55702 | 69 | | |
| D146-12050 | 64 | D146-46702 | 59 | D146-50604 | 37 | D146-55703 | 69 | | |
| D146-12075 | 64 | D146-46703 | 59 | D146-50605 | 37 | D146-55920 | 42 | | |
| D146-12090 | 64 | D146-46704 | 59 | D146-50608 | 37 | D146-56018 | 69 | | |
| D146-12435 | 64 | D146-46705 | 59 | D146-50919 | 36 | D146-56218 | 69 | | |
| D146-12450 | 64 | D146-46706 | 59 | D146-50920 | 36 | D146-56502 | 46 | | |
| D146-12475 | 64 | D146-46709 | 59 | D146-51022 | 38 | D146-56614 | 69 | | |
| D146-12490 | 64 | D146-46710 | 59 | D146-51916 | 37 | D146-56810 | 50 | | |
| D146-15420 | 34 | D146-46810 | 60 | D146-52101 | 39 | D146-57123 | 63 | | |
| D146-21002 | 81 | D146-46814 | 60 | D146-52102 | 39 | D146-57223 | 63 | | |
| D146-25318 | 62 | D146-46816 | 60 | D146-52201 | 36 | D146-57323 | 63 | | |
| D146-25520 | 62 | D146-46907 | 58 | D146-52203 | 36 | D146-57523 | 63 | | |
| D146-26120 | 12 | D146-46917 | 58 | D146-52205 | 36 | D146-57719 | 67 | | |
| D146-26122 | 12 | D146-46927 | 58 | D146-52207 | 36 | D148-32400 | 51 | | |
| D146-32519 | 81 | D146-47102 | 59 | D146-52321 | 38 | D148-56411 | 40 | | |



darleys **S U R G I C A L C O.**

Quality Instruments Since 1992

Manufacturer & Exporters of Surgical Instruments

2-A Kutchery Road, Sialkot-51310 Pakistan

Tel: +92 52 426 9230 Fax: +92 52 458 6215

E-Mail: info@darleys-surgical.com

 **darleys-surgical**  **fb.com/darleyssurgical**  **twitter.com/darleyssurgical**

www.darleys-surgical.com

